

## 30.5 mm Push Buttons

- Bulletin 800T/800H ..... **Page 10-2**

## 22.5 mm Push Buttons

- Bulletin 800F ..... **Page 10-66**
- Bulletin 800FC Configured Pendant Stations ..... **Page 10-127**
- Bulletin 800FD Monolithic ..... **Page 10-140**
- Bulletin 800M ..... **Web†**

## 16 mm Push Buttons

- Bulletin 800B ..... **Page 10-146**

## Specialty Push Buttons

### Hazardous Location Push Buttons

- Bulletin 800H Type 7 & 9 ..... **Page 10-152**
- Bulletin 800R ..... **Page 10-189**
- Bulletin 800G ..... **Page 10-194**

### Touch/Palm Push Buttons

- Bulletin 800P Palm Operated ..... **Page 10-210**
- Bulletin 800Z Zero-Force™ ..... **Page 10-214**

### Miscellaneous Push Buttons

- Bulletin 800L Indicators ..... **Page 10-221**
- Bulletin 800H Security Stations ..... **Web†**
- Bulletin 800S Stations ..... **Page 10-223**

† Information for this product line is available on the Industrial Controls Catalog website: [www.ab.com/catalogs](http://www.ab.com/catalogs).



**Bulletin 800T/800H 30.5 mm Push Buttons**

- 30.5 mm mounting hole
- Type 4/13 watertight/oiltight (Bul. 800T)
- Type 4/4X/13 corrosion-resistant/watertight/oiltight (Bul. 800H)
- Heavy industrial stations and operators

**Description**

The Allen-Bradley Bulletin 800T and 800H 30.5 mm push button product lines are in a class by themselves. They are designed and constructed to perform in the most demanding industrial environments. In terms of sealing and switching performance, you will not find a more dependable push button offering. Allen-Bradley delivers more styles and options of operator types and contact blocks, offering flexibility to meet the most demanding specifications in the world's toughest industrial environments.

Design innovation is key to the performance advantage provided in the Bulletin 800T and 800H offerings. New in this catalog are the **Trigger Action E-Stop** operators, the new standard bearer in a tamper-resistant design. Also new is the **Universal LED Illumination** option that accepts a wide 12...130V AC/DC voltage input. This is compatible with all illuminated operator types, allows retrofitting in existing installations, and incorporates super bright LED technology.

**Table of Contents**

See below.

**Standards Compliance**

UL 508

CCC

**Certifications**

UL Listed  
 (File No. E14840, E10314  
 Guide No. NKCR, NOIV)

CSA Certified  
 (File No. LR1234, LR11924)

CSA C22.2, No. 14

EN/IEC: 60947-5-1

**TABLE OF CONTENTS**

Description	Page	Description	Page
<b>Specifications</b> .....	10-3	<b>Specialty Operators</b>	
<b>Assembled Stations</b> .....	10-5	Potentiometer .....	10-25
<b>DeviceNet Stations</b> .....	10-6	Mechanically Interlocked Push Button .....	10-25
<b>Trigger Action E-Stops</b> .....	10-7	Cluster Pilot Light.....	10-26
<b>Push Buttons, Momentary</b>		18 mm Small Pilot Light .....	10-27
Non-Illuminated.....	10-9	1-, 2-, 3-, 4-Way Toggle Switch .....	10-28
Illuminated.....	10-10	Selector Push Button.....	10-29
Non-Illuminated — with Two-Color Molded Legend Cap .....	10-11	Cylinder Lock Push Button .....	10-30
<b>Selector Switches, Non-Illuminated</b>		Padlocking Mushroom Head .....	10-30
2-Position .....	10-12	Wobble Stick.....	10-30
3-Position .....	10-14	Flip Lever Operator.....	10-31
4-Position .....	10-16	Break-Glass Push Button Station.....	10-32
<b>Selector Switches, Illuminated</b>		<b>Custom-Built Stations</b> .....	10-33
2-Position .....	10-18	<b>Enclosures</b> .....	10-33
3-Position .....	10-19	<b>Accessories</b>	
<b>Pilot Light Devices</b> .....	10-20	Contact Blocks.....	10-35
<b>Emergency Stop Operators</b>		Power Modules and Universal LED Module.....	10-36
Push-Pull, Non-Illuminated		Replacement Color Caps.....	10-37
2-Position.....	10-21	Selector Switch Knobs.....	10-38
3-Position.....	10-22	Protective Boots .....	10-39
Push-Pull, Illuminated		Push Buttons & Miscellaneous .....	10-40
2-Position.....	10-23	Locking Attachments.....	10-42
3-Position.....	10-24	Guards .....	10-44
		Replacement Lamps .....	10-45
		Replacement Keys.....	10-46
		Legend Plates.....	10-47
		<b>Approximate Dimensions &amp; Shipping Weights</b> .....	10-53
		<b>Typical Pilot Light Wiring Diagram</b> .....	10-65

**Specifications\***

Electrical Ratings		
Contact ratings	Refer to the contact ratings tables on page 10-4.	
Dielectric strength	2200V for one minute, 1300V for one minute (Logic Reed)	
Electrical design life cycles	1 000 000 at max. rated load, 200 000 at max. rated load (Logic Reed)	
Mechanical Ratings		
Vibration	10...2000 Hz, 1.52 mm displacement (peak-to-peak) max./ 10 G max. (except Logic Reed)	
Shock	1/2 cycle sine wave for 11 ms ≥ 25 G (contact fragility) and no damage at 100 G	
Degree of protection	Type 1/4/12/13 (800T); Type 1/4/4X/12/13 (800H); EN/IEC 60529 IP66/65	
Mechanical design life cycles		
Push buttons	(Momentary, non-illuminated)	10 000 000 min.
	(Momentary, illuminated)	250 000 min.
	(Push-pull/twist-to-release)	250 000 min.
Selector switches	(Non-illuminated)	1 000 000 min.
	(Illuminated, key-operated)	200 000 min.
Potentiometers	25 000 min.	
All other devices	200 000 min.	
Contact operation	Shallow, mini, and low-voltage contact blocks: Slow, double make and break Logic Reed and sealed switch contact blocks: Single break magnetic	
Wire gauge/Terminal screw torque	#18...14 AWG (#18...10 Max Duty) / 6...8 lb•in	
Typical operating forces		
Operators without contact blocks	Flush, extended button, standard mushroom, jumbo plastic mushroom: 2 lbs max. Jumbo and extended aluminum mushroom head: 3.95 lbs max. Maintained selector switch: 3.6 in•lb max.	
Spring return selector switches	3.6 in•lb to stop, 0.2 in•lb to return	
Illuminated push buttons and push-to-test pilot lights	5 lb max.	
2-position push-pull	8.0 lb max. push or pull	
3-position push-pull	8 lb max. push to in position or pull to center position (15 lb max. pull to out position)	
Twist-to-release or push-pull	9 lbs max. push or pull 30 in•oz max. twist, 6 in•oz minimum return	
Potentiometer	Rotational torque 3...12 in•oz; stopping torque 12 in•lb (minimum)	
Contact blocks	Standard	1 lb
	Logic Reed	1 lb max.
	Sealed switch	3 lb max. at 0.205 in. plunger travel
	Stackable sealed switch	1 lb max.
	MaxDuty	1.4 lb max.
	PenTUFF	1.4 lb max.
Self Monitoring	1.6 lb	
Environment		
Temperature range	Operating	-40...+131 °F (-40...+55 °C)
	Storage	-40...+185 °F (-40...+85 °C)
<b>Note:</b> Operating temperatures below freezing are based on the absence of moisture and liquids. Consult your local Rockwell Automation sales office or Allen-Bradley distributor for use in lower temperature applications.		
Humidity	50...95% RH from 77...140 °F (25...60 °C) per Procedure IV of MIL-STD-810C, Method 507.1 cycling test	

\* Performance Data — See Important- 3.

# 30.5 mm Push Buttons

## Specifications

### Standard Contact Ratings

Minimum: 24V, 24 mA

Maximum thermal continuous current  $I_{th}$  10 A AC/2.5 A DC. Bulletin 800T units with 800T-XA contacts have ratings as follows:

Max. Operntl. Volts $U_e$	Utilization Category		Rated Operational Currents		
	IEC	NEMA	Volts $U_e$	Make	Break
AC 600	AC-15	A600	120...600	7200VA	720VA
			72...120	60 A	720VA
			24...72	60 A	10 A
DC 600	DC-13	Q600	28...600	69VA	
			24...28*	2.5 A	

\* For applications below 24V/24 mA, PenTUFF or Logic Reed contacts are recommended.

### Sealed Switch Contact Ratings

Minimum: 5V, 1 mA

Maximum continuous current  $I_{th}$  5 A. Bulletin 800T units have control circuit ratings with sealed switch contact blocks as follows:

Max. Operntl. Volts $U_e$	Utilization Category		Rated Operational Currents		
	IEC	NEMA	Volts $U_e$	Make	Break
AC 600	AC-15	B600	120...600	3600VA	360VA
			0...120	30 A	3 A
DC 300	DC-13	P300	24...300	138VA	
			0...24	5.0 A	

### Stackable Sealed Switch Contact Ratings

Minimum: 5V, 10 mA (digital); 24V, 1 mA (analog)

Maximum continuous current  $I_{th}$  2.5 A. Bulletin 800T units have control circuit ratings with sealed switch contact blocks as follows:

Max. Operntl. Volts $U_e$	Utilization Category		Rated Operational Currents		
	IEC	NEMA	Volts $U_e$	Make	Break
AC 300	AC-15	C300	120...300	1800VA	180VA
			0...120	15 A	1.5 A
DC 150	DC-13	Q150	24...150	69VA	
			0...24	2.5 A	

### Logic Reed Contact Ratings

Minimum — DC: 5V, 1 mA

Maximum — DC: 30V, 0.06 A, AC: 150V, 0.15 A

Should only be used with resistive loads.

### Materials Used in 800H Type 4X Operators

#### Thermoplastic Polyester (Fiberglass Reinforced)

- Bushings
- Mounting Rings
- Sockets

#### Thermoplastic Polyester

- Non-illuminated button caps

#### Transparent Amorphous Nylon

- Pilot light lens cap
- Illuminated button caps

#### Glass Filled Crystalline Nylon

- Thrust washer

#### Mineral Filled Nylon

- Trim washer

#### Nitrile (Synthetic Rubber)

- Gaskets and internal seals

### PenTUFF™ (Low Voltage) Contact Ratings

Minimum DC: 5V, 1 mA

Maximum thermal continuous current  $I_{th}$  2.5 A AC/1.0 A DC. Bulletin 800T units with 800T-XAV contacts have ratings as follows:

Max. Operntl. Volts $U_e$	Utilization Category		Rated Operational Currents		
	IEC	NEMA	Volts $U_e$	Make	Break
AC 300	AC-15	C300	120...300	1800VA	180VA
			0...120	15 A	1.5 A
DC 150	DC-13	R150	24...150	28VA	
			0...24	1.0 A	

### Snap Action Contact Ratings

Max. Operntl. Volts $U_e$	Contact Rating Designation	Rated Operational Currents		
		Volts $U_e$	Make	Break
AC 300	A300	120...300	7200VA	720VA
		24...72	60 A	10 A
DC 250	—	230...250	0.2 A	
		115...125	0.4 A	

### MaxDuty Contact Rating

Maximum thermal continuous current  $I_{th}$  24 A.

Pilot Duty — 120V AC, 12 A; 24V DC, 10 A

Motor Ratings — 120V AC, 1.5 Hp; 240V AC, 3 Hp; 24V DC, 10 A FLA/60 A LRA

### Time Delay Contacts

Max. Operntl. Volts $U_e$	Contact Rating Designation	Rated Operational Currents		
		Volts $U_e$	Make	Break
AC 120	B150	120	3600VA	360VA

**Note:** This device is not rated for DC applications.

Adjustment range: 0.5...15 s  $\pm$  25%  $I_{th}$  = 5 A

Product Selection  
 Assembled Stations



Die Cast Aluminum  
 Cat. No. **800T-2TAR**



Booted Operator – Stainless Steel  
 Cat. No. **800H-1HA4T**



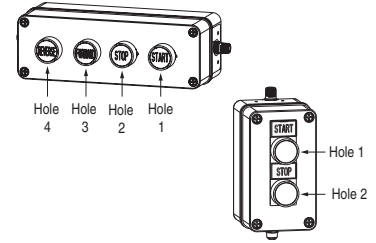
Booted Operator – Glass Polyester  
 Cat. No. **800H-1HA4R**

Operator	Contact Symbol	Contact Action	Button Type	Button Color	Legend Marking	Type 4/13	Type 4/4X/13	
						Die Cast Aluminum Cat. No.	Booted Operator – Stainless Steel Cat. No.*	Booted Operator – Glass Polyester Cat. No.*
One Push Button		Momentary	Extended	Red	STOP	<b>800T-1TA</b>	800H-1HA4T	800H-1HA4R
		Momentary	Flush	Green	START	800T-1TB	800H-1HB4T	800H-1HB4R
		Momentary	Flush	Black	No Legend	<b>800T-1TX</b>	800H-1HX4T	800H-1HX4R
Two Push Buttons		Momentary	Flush Extended	Green Red	START STOP	<b>800T-2TA</b>	<b>800H-2HA4T</b>	<b>800H-2HA4R</b>
		Momentary	Flush Flush	Black Black	No Legend	<b>800T-2TX</b>	800H-2HX4T	800H-2HX4R
One Pilot Light, Two Push Buttons		Momentary	120V AC Flush Extended	Red Green Red	No Legend START STOP	<b>800T-2TAR</b>	800H-2HAR4T	<b>800H-2HAR4R</b>
		Momentary	120V AC Flush Flush	Red Black Black	No Legend	800T-2TXR	800H-2HXR4T	800H-2HXR4R
3-Position Selector Switch		Maintained	Knob Lever	Black with white insert	HAND-OFF-AUTO	<b>800T-R3TA</b>	—	—
		Maintained	Knob Lever	Black with white insert	No Legend	800T-R3TX	—	—
One Push Button		Maintained	Push-Pull/Twist	Red	EMERG STOP	<b>800T-1TYM*</b>	—	—
Two Push Buttons		Maintained	Flush Extended	Green Red	START STOP	<b>800T-2TAM</b>	800H-2HAM4T	800H-2HAM4R
		Maintained	Flush Flush	Black Black	No Legend	800T-2TXM	800H-2HXM4T	800H-2HXM4R

\* Boot material is chlorosulfonated polyethylene. Add suffix **L** to the cat. no. for station with bootless operators. Example: **Cat. No. 800H-1HB4T** becomes **Cat. No. 800H-1HB4TL**.

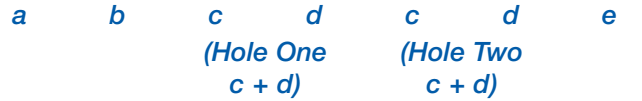
\* Supplied with yellow legend plate to comply with IEC 60947-5-5 and NFPA79 E-Stop standards that require yellow background.

DeviceNet Stations



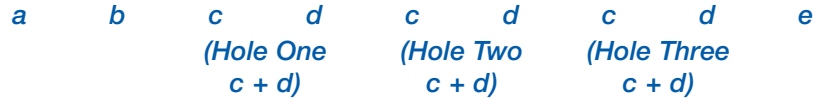
**Two-Unit**

**800T –**



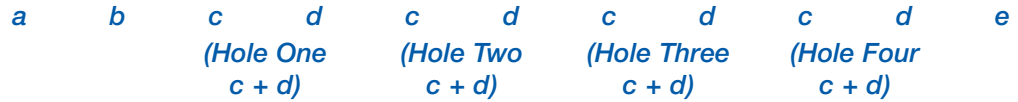
**Three-Unit**

**800T –**



**Four-Unit**

**800T –**



**a**

Orientation	
Code	Description
V	Vertical
H	Horizontal

**b**

Enclosure Style		
Grey Code	Description	Yellow Code
A	2-hole	K
B	3-hole	L
C	4-hole	M
G	E-stop only§	N

**c**

Operator Types	
Code	Description
A	Non-illuminated flush (800T-A*)
B	Non-illuminated extended (800T-B*)
C	Non-illuminated mushroom (800T-D*)
D	Illuminated mushroom (800T-QM*)
E	Illuminated extended (800T-QB*)
F	Illuminated guarded (800T-QA*)
G	2-position SS maintained (800T-H2*)
H	3-position SS maintained (800T-J2*)
J	Enhanced pilot light (800T-QH*)
K	Non-illuminated 2-position push/pull (800T-FX*)‡
L	Non-illuminated push/pull twist-to-release (800T-FXT*)‡
M	Illuminated 2-position push/pull (800T-FXQH*)
N	2-position key SS (800T-H33*)*
P	3-position key SS (800T-J44*)*
Q	2-position SS spring return from right (800T-H5*)
R	3-position SS spring return from all (800T-J91*)
T	Illuminated 2-position SS maintained (800T-24H*H*)
U	Illuminated 3-position SS maintained (800T-24J*H*)
V	Non-illuminated 3-position push/pull (800T-FXM*)
W	Potentiometer⌘

**d**

Color/Text	
Code	Description
1	Green
2	Black (non-illuminated only)
3	Orange (non-illuminated only)
4	Grey (non-illuminated only)
5	White
6	Red
7	Blue
8	Clear (illuminated only)
9	Yellow (non-illuminated)/amber (illuminated)
A	Green with Start legend
B	Red with Stop legend
C	Red with E-Stop legend
D	Black with Off/On legend
E	Black with Hand/Off/Auto legend
F	Red with Push to Stop/Pull to Start legend
G	Blue with Reset legend
H	Red with Power On legend
X	N/A (i.e. key ss)

**e**

External I/O Version➤	
Code	Description
Blank	No external I/O
A	1 input/1 output (sinking)
B	1 input/1 output (sourcing)
C	2 input
D	2 output (sinking)
E	2 output (sourcing)
F	1 E-stop block⌘
G	2 E-stop blocks⌘
H	2 input + 2 output
J	2 input + 2 output (sinking)
K	2 input + 2 output (sourcing)
L	1 input/1 output (sinking) + 1 E-stop block⌘
M	1 input/1 output (sourcing) + 1 E-stop block⌘
N	1 input/1 output (sinking) + 2 E-stop blocks⌘
P	1 input/1 output (sourcing) + 2 E-stop blocks⌘
Q	2 input + 1 E-stop block⌘
R	2 input + 2 E-stop blocks⌘
T	2 output (sinking) + 1 E-stop block⌘
U	2 output (sourcing) + 1 E-stop block⌘
V	2 output (sinking) + 2 E-stop blocks⌘
W	2 output (sourcing) + 2 E-stop blocks⌘
X	2 input + 1 input/1 output (sinking)
Y	2 input + 1 input/1 output (sourcing)

\* Operator Types N and P from Table c must choose Color/Text option X from Table d.  
 ‡ Operator Types K and L from Table c may be used as Emergency Stops. To be valid as an E-Stop, the operators must use Color/Text option C from Table d and it must be placed in the last hole position in the enclosure. An E-Stop connector also must be chosen from Table e.  
 § Enclosure Style option G from Table b can only select one operator from Table c. Valid options are K and L with E-Stop.  
 ⌘ External I/O Versions F, L, M, Q, T and U receive only one contact block for the external E-Stop string. These connectors are rated to 3 A. If more than 3 A of current is needed or if there are two E-Stop strings, use External I/O Versions G, N, P, R, V, and W. These versions receive two contact blocks. This allows for 6 A of switching or for two E-Stop strings.  
 ➤ This is an 8-in/4-out device. 2-in/1-out is assigned to each hole position in the enclosure. If a 2-hole enclosure is selected, 4-in and 2-out are assigned internally and up to 4 unassigned I/O points can be assigned to external connectors. This device contains up to two physical external I/O connectors. The "+" symbol in the Description field of Table e indicates that two external connectors exist. If an E-Stop connector is used, 2 unassigned I/O points can be assigned to the other connector.  
 ⌘ Available for certain applications, please contact your local Allen-Bradley distributor.

**2-Position Red Trigger Action Twist-to-Release, Non-Illuminated**

- Tamper resistant – front-of-panel mounting and non-removable operator head
- Compliant with global E-stop standards, including EN ISO 13850 and EN 60947-5-5



Cat. No. 800T-TFXJET6



Cat. No. 800T-TFXLET6



Cat. No. 800T-TFXK6



Cat. No. 800H-TFRXT6

Contact Type	Operator Position		Type 4/13			Type 4/4X/13
			45 mm Plastic	63 mm Metal	Key Release	45 mm Plastic
	Out	In	Cat. No.* <b>‡</b>	Cat. No.* <b>§</b>	Cat. No.* <b>♣</b>	Cat. No.* <b>‡</b>
No contacts	—	—	<b>800T-TFXT6</b>	<b>800T-TFXLT6</b>	<b>800T-TFXK6</b>	<b>800H-TFRXT6</b>
1 N.C.	X	O	800T-TFXT6D2	800T-TFXLT6D2	800T-TFXK6D2	800H-TFRXT6D2
1 N.O. - 1 N.C.	O X	X O	<b>800T-TFXT6A</b>	800T-TFXLT6A	<b>800T-TFXK6A</b>	<b>800H-TFRXT6A</b>
1 S.M.C.B.➤	X	O	800TC-TFXT6D4S	800TC-TFXLT6D4S	800TC-TFXK6D4S	800HC-TFRXT6D4S

\* For finger-safe contact block terminals, add a **C** to the cat. no. Example: Cat. No. 800TC-TFXT6 or 800HC-TFRXT6.

‡ To order a device with a jumbo (60 mm) plastic head add the letter **J** after **X**. Example: Cat. No. 800T-TFXJT6A or 800H-TFRXT6A.

§ To order a device with "E-STOP" engraved on the cap add the letter **E** after **L**. Example: Cat. No. 800TC-TFXLET6D4S.

♣ Provided with two DO18 keys.  
 ➤ Self-monitoring contact block.



Protection Rating	
Code	Description
T	Metal, Type 4/13
H	Plastic, Type 4/4X/13

Finger-Safe Guards	
Code	Description
Blank	No guards
C	Guards on terminals

Head Type‡		
800T Type 4/13	Description	800H Type 4/4X/13
Code		Code
FX	Standard (45 mm) mushroom head	FRX
FXJ	Jumbo (60 mm) mushroom head	FRXJ
FXJE	Jumbo (60 mm) mushroom head with "E-STOP"	FRXJE
FXK	45 mm mushroom head key release	—
FXL	63 mm anodized aluminum head	—
FXLE	63 mm anodized aluminum head with "E-STOP"	—

Release Function	
Code	Color
Blank	Key release $\%$
T	Twice release

**Note:** X = Closed/O = Open  
 $\%$  Configurable only with **FXK** head type.

Contact Block(s)			
Code	Operator Position		Description
	Out	In	
Blank	—	—	No contacts on operator
<b>Standard</b>			
D1	O	X	1 N.O.
D2	X	O	1 N.C.
D4	X	O	1 N.C.L.B.
A	O X	X O	1 N.O. - 1 N.C.
A1	O X	X O	1 N.O. - 1 N.C.L.B.
A5	X X	O O	2 N.C.L.B.
<b>PenTUFF (Low Voltage)</b>			
D1V	O	X	1 N.O.
D2V	X	O	1 N.C.
D4V	X	O	1 N.C.L.B.
AV	O X	X O	1 N.O. - 1 N.C.
<b>Class 1, Div. 2/Zone 2</b>			
<b>Logic Reed</b>			
D1R	O	X	1 N.O.
D2R	X	O	1 N.C.
AR	O X	X O	1 N.O. - 1 N.C.
<b>Sealed Switch</b>			
D1P	O	X	1 N.O.
D2P	X	O	1 N.C.
AP	O X	X O	1 N.O. 1 N.C.
<b>Stackable Sealed Switch</b>			
D1Y	O	X	1 N.O.
D2Y	X	O	1 N.C.
AY	O X	X O	1 N.O. - 1 N.C.









Momentary Contact Push Button Devices, Non-Illuminated



Flush Head Unit  
 Cat. No. 800T-A1A



Extended Head Unit  
 Cat. No. 800T-B6A



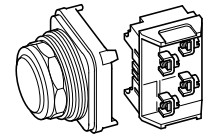
Booted Unit  
 Cat. No. 800H-R2A



Bootless Flush Head Unit  
 Cat. No. 800H-AR1A

Contact Type	Button Color	Type 4/13		Type 4/4X/13	
		Flush Head	Extended Head	Booted*	Bootless Flush Head
		Cat. No.	Cat. No.	Cat. No.	Cat. No.
No Contact	Green	800T-A1	800T-B1	800H-R1	800H-AR1
	Black	800T-A2	800T-B2	800H-R2	800H-AR2
	Red	800T-A6	800T-B6	800H-R6	800H-AR6
1 N.O.	Green	800T-A1D1	800T-B1D1	800H-R1D1	800H-AR1D1
	Black	800T-A2D1	800T-B2D1	800H-R2D1	800H-AR2D1
	Red	800T-A6D1	800T-B6D1	800H-R6D1	800H-AR6D1
1 N.C.	Green	800T-A1D2	800T-B1D2	800H-R1D2	800H-AR1D2
	Black	800T-A2D2	800T-B2D2	800H-R2D2	800H-AR2D2
	Red	800T-A6D2	800T-B6D2	800H-R6D2	800H-AR6D2
1 N.O. - 1 N.C.	Green	800T-A1A	800T-B1A	800H-R1A	800H-AR1A
	Black	800T-A2A	800T-B2A	800H-R2A	800H-AR2A
	Red	800T-A6A	800T-B6A	800H-R6A	800H-AR6A

800 T - A 1 A  
 a b c d e f



**a**

Protection Rating	
Code	Description
T	Metal, Type 4/13
H	Plastic, Type 4/4X/13

**b**

Finger-Safe Guards	
Code	Description
Blank	No guards
C	Guards on terminals

**c**

Operator Type		
800T Type 4/13	Description	800H Type 4/4X/13
Code		Code
A	Flush head	AR
B	Extended head	BR
D	Mushroom head	DR
DX	Mushroom head less color cap	DRX
—	Bootless guarded head	GR
—	Booted head	R*

**d**

Color Cap	
Code	Description
Blank	Used only when ordering Operator Type DX/DRX
1	Green
2	Black
3	Orange*

**d (cont'd)**

Color Cap	
Code	Description
4	Grey*
5	White*
6	Red
7	Blue
9	Yellow

**e**

Special Mushroom Head	
Code	Description
J§	Jumbo mushroom head — plastic
L§	Jumbo mushroom head — metal

**Note:** Special mushroom head options only apply to mushroom head operator type code D/DR (Table c).

**f**

Contact Block(s)	
Code	Description
Blank	No contacts
Standard	
D1	1 N.O.
D2	1 N.C.
D3	1 N.O.E.M.
D4	1 N.C.L.B.
D5	1 N.O. (Mini)
D6	1 N.C. (Mini)
A1	1 N.C.L.B. - 1 N.O.
A2	2 N.O.‡
A4	2 N.C.
A7	1 N.C.L.B. - 1 N.C.
A	1 N.O. - 1 N.C.
B	2 N.O. - 2 N.C.

**f (cont'd)**

Contact Block(s)	
Code	Description
PenTUFF (Low Voltage)	
D1V	1 N.O.
D2V	1 N.C.
D3V	1 N.O.E.M.
D4V	1 N.C.L.B.
AV	1 N.O. - 1 N.C.
BV	2 N.O. - 2 N.C.

**Time Delay**

Code	Description
T	1 N.O. Depress close, delayed opening
S	1 N.C. Depress open, delayed closure

**Snap Action**

Code	Description
M	1 N.O. - 1 N.C.
N	2 N.O. - 2 N.C.

**Class 1, Div. 2/Zone 2**

Logic Reed	
Code	Description
D1R	1 N.O.
D2R	1 N.C.
A2R	2 N.O.‡
A4R	2 N.C.
AR	1 N.O. - 1 N.C.
BR	2 N.O. - 2 N.C.

**f (cont'd)**

Contact Block(s)	
Code	Description
Class 1, Div. 2/Zone 2	
Sealed Switch	
D1P	1 N.O.
D2P	1 N.C.
AP	1 N.O. - 1 N.C.
BP	2 N.O. - 2 N.C.
Stackable Sealed Switch	
D1Y	1 N.O.
D2Y	1 N.C.
A2Y	2 N.O.
A4Y	2 N.C.
AY	1 N.O. - 1 N.C.
BY	2 N.O. - 2 N.C.

**Time Delay Contacts**

Series C field installable kits can only be used with Series T or later operators. Adjustable range of 0.5 to 15 s + 25%. Maximum continuous current I<sub>th</sub> 5 A.

**Snap Action Contacts**

Snap-action contacts feature a quick make, quick break snap-action mechanism that is only available on factory assembled units. Maximum continuous current I<sub>th</sub> 10 A.

\* Underlying operators are "flush head" type, except red which are "extended head". Boot material is chlorosulfonated polyethylene.

‡ Not available for booted operators.

‡ A2 and A2R contact blocks cannot be stacked upon, but can stack on other contact blocks.

§ Jumbo mushroom heads not available in white color.

Bulletin 800T/H  
**30.5 mm Push Buttons**  
 Push Button Operators

Momentary Contact Push Button Devices, Illuminated



Extended Head Without Guard  
**Cat. No. 800T-PB16R**



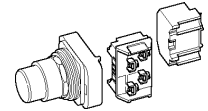
Extended Head with Guard  
**Cat. No. 800H-PRB16R**

Type	Lamp Type	Volts	Color	Type 4/13		Type 4/4X/13	
				Extended Head Without Guard*	Extended Head With Guard*	Extended Head without Guard*	Extended Head with Guard*
				Cat. No.	Cat. No.	Cat. No.	Cat. No.
Operator Only*				<b>800T-SB00XX</b>	800T-SA00XX	800H-SRB00XX	800H-SRA00XX
Full Voltage	Incandescent	24V AC/DC	Red	<b>800T-QB24R</b>	<b>800T-QA24R</b>	<b>800H-QRB24R</b>	800H-QRA24R
			Green	<b>800T-QB24G</b>	<b>800T-QA24G</b>	<b>800H-QRB24G</b>	<b>800H-QRA24G</b>
			Amber	<b>800T-QB24A</b>	<b>800T-QA24A</b>	<b>800H-QRB24A</b>	<b>800H-QRA24A</b>
Universal	LED	12...130V AC/DC	No Lens	800T-QBN25	800T-QAN25	800H-QRBN25	800H-QRAN25
			Red	<b>800T-QBH2R</b>	<b>800T-QAH2R</b>	<b>800H-QRBH2R</b>	<b>800H-QRAH2R</b>
			Green	<b>800T-QBH2G</b>	<b>800T-QAH2G</b>	<b>800H-QRBH2G</b>	<b>800H-QRAH2G</b>
Transformer	Incandescent	120V AC, 50/60 Hz	Amber	<b>800T-QBH2A</b>	<b>800T-QAH2A</b>	<b>800H-QRBH2A</b>	<b>800H-QRAH2A</b>
			Red	<b>800T-PB16R</b>	<b>800T-PA16R</b>	<b>800H-PRB16R</b>	<b>800H-PRA16R</b>
			Green	<b>800T-PB16G</b>	<b>800T-PA16G</b>	<b>800H-PRB16G</b>	<b>800H-PRA16G</b>
	Amber		<b>800T-PB16A</b>	<b>800T-PA16A</b>	<b>800H-PRB16A</b>	<b>800H-PRA16A</b>	
	LED		Red	<b>800T-PBH16R</b>	<b>800T-PAH16R</b>	<b>800H-PRBH16R</b>	<b>800H-PRAH16R</b>
	Green		<b>800T-PBH16G</b>	<b>800T-PAH16G</b>	<b>800H-PRBH16G</b>	<b>800H-PRAH16G</b>	
	Amber		<b>800T-PBH16A</b>	<b>800T-PAH16A</b>	<b>800H-PRBH16A</b>	<b>800H-PRAH16A</b>	
No Lamp	No Lens	800T-PBN16	800T-PAN16	800H-PRBN16	800H-PRAN16		

\* Includes as standard one Cat. No. 800T-XA (1 N.O. - 1 N.C.) contact block.

\* Operator only supplied without power module, lamp, lens cap, or contact blocks.

800 T - P B H 16 R  
 a b c d e f g h



**a**

Protection Rating	
Code	Description
T	Metal, Type 4/13
H	Plastic, Type 4/4X/13

**b**

Finger-Safe Guards	
Code	Description
Blank	No guards
C	Guards on terminals

**c**

Power Module Type		
800T Type 4/13	Description	800H Type 4/4X/13
Code		Code
P	Transformer (or dual input)	PR
Q	Full voltage/ Universal	QR

**d**

Head Type	
Code	Description
A	Extended head with guard
B	Extended head without guard
M	Mushroom
MJ	Jumbo mushroom

**e**

Illumination Options	
Code	Description
Blank	Incandescent
H	LED
Dual Input	
D	Diode type ‡
T	Transformer — relay type
TH	Transformer — relay type LED

**f**

Voltage	
Transformer	
Code	Description
16	120V AC, 50/60 Hz
26	240V AC, 50/60 Hz
46	480V AC, 50/60 Hz
56	600V AC, 50/60 Hz
Full Voltage — Incandescent	
12	12V AC/DC
24	24V AC/DC
48	48V AC/DC
10	120V AC/DC
20	240V AC/DC
Universal — LED	
2	12...130V AC/DC
Dual Input	
16	120V AC
24	24V AC/DC ➤

**g**

Lens Color	
Code	Description
Blank	No lens with standard contacts 1 N.O. - 1 N.C.
X	No lens if ordering any contacts other than standard 1 N.O. - 1 N.C.
A	Amber
B	Blue
C	Clear
G	Green
R	Red
W	White

**h**

Contact Block(s)	
Code	Description
X	No contacts
Standard	
Blank	1 N.O. - 1 N.C.
D1	1 N.O.
PenTUFF (Low Voltage)	
AV	1 N.O. - 1 N.C.
Class 1, Div. 2/Zone 2	
Logic Reed	
AR	1 N.O. - 1 N.C.
Sealed Switch	
AP	1 N.O. - 1 N.C.
Stackable Sealed Switch	
AY	1 N.O. - 1 N.C.

‡ Diode type dual input provides circuit isolation via opposing diodes. Not recommended for use with solid-state outputs.  
 ➤ Dual input diode only.



**Momentary Contact Push Button Devices, Non-Illuminated — With Two-Color Molded Legend Caps**

**Operator Only**

- Less legend cap
- Less contact blocks

Button Type	Type 4/13	Type 4/4X/13
	Cat. No.	Cat. No.
Flush	<b>800T-A00</b>	<b>800H-AR00</b>
Extended	<b>800T-B00</b>	<b>800H-BR00</b>



Cat. No. 800T-A00 with  
 Cat. No. 800T-LC103W  
 installed



Cat. No. 800H-BR00 with  
 Cat. No. 800T-LC604  
 installed

**Legend Caps**

Text	Cap Color	Text Color	Cat. No.
	Green	White	800T-LC101W
START			800T-LC103W
ON			800T-LC105W
START / I			800T-LC121W
O	Black	White	800T-LC202W
STOP			800T-LC204W
RESET			800T-LC207W
↑			800T-LC208W
FORWARD			800T-LC209W
REVERSE			800T-LC210W
JOG			800T-LC212W
UP			800T-LC213W
DOWN			800T-LC214W
RAISE			800T-LC215W
LOWER			800T-LC216W

Text	Cap Color	Text Color	Cat. No.
IN	Black	White	800T-LC217W
OUT			800T-LC218W
HIGH			800T-LC219W
LOW			800T-LC220W
STOP / O			800T-LC222W
	White	Black	800T-LC501B
START			800T-LC503B
↑			800T-LC508B
START / I			800T-LC521B
O	Red	White	800T-LC602W
STOP			800T-LC604W
OFF			800T-LC606W
STOP / O			800T-LC622W
RESET	Blue	White	800T-LC707W
R			800T-LC711W

**Note:** Package Qty. = 1

**800 T - A 103W A**

*a b c d e*

**a**

Protection Rating	
Code	Description
T	Metal, Type 4/13
H	Plastic, Type 4/4X/13

**b**

Finger-Safe Guards	
Code	Description
Blank	No guards
C	Guards on terminals

**c**

Operator Type		
800T Type 4/13	Description	800H Type 4/4X/13
Code		Code
A	Flush head	AR
B	Extended head	BR

**d**

Cap Text/Color					
Code	Text	Color			
		Cap	Text		
101W		Green	White		
103W	START				
105W	ON				
121W	START / I				
202W	O				
204W	STOP	Black	White		
207W	RESET				
208W	↑				
209W	FORWARD				
210W	REVERSE				
212W	JOG				
213W	UP				
214W	DOWN				
215W	RAISE				
216W	LOWER				
217W	IN			White	Black
218W	OUT				
219W	HIGH				
220W	LOW				
222W	STOP / O				
501B		Red	White		
503B	START				
508B	↑				
521B	START / I				
602W	O	Blue	White		
604W	STOP				
606W	OFF				
622W	STOP / O				
707W	RESET	Blue	White		
711W	R				

**e**

Contact Block(s)	
Code	Description
Blank	No contacts
Standard	
D1	1 N.O.
D2	1 N.C.
D3	1 N.O.E.M.
D4	1 N.C.L.B.
D5	1 N.O. (Mini)
D6	1 N.C. (Mini)
A1	1 N.C.L.B. - 1 N.O.
A2	2 N.O.‡
A4	2 N.C.
A7	1 N.C.L.B. - 1 N.C.
A	1 N.O. - 1 N.C.
B	2 N.O. - 2 N.C.
Class 1, Div. 2/Zone 2	
Sealed Switch	
D1P	1 N.O.
D2P	1 N.C.
AP	1 N.O. - 1 N.C.
BP	2 N.O. - 2 N.C.
Stackable Sealed Switch	
D1Y	1 N.O.
D2Y	1 N.C.
A2Y	2 N.O.
A4Y	2 N.C.
AY	1 N.O. - 1 N.C.
BY	2 N.O. - 2 N.C.

**e (cont'd)**

Contact Block(s)	
Code	Description
PenTUFF (Low Voltage)	
D1V	1 N.O.
D2V	1 N.C.
D3V	1 N.O.E.M.
D4V	1 N.C.L.B.
AV	1 N.O. - 1 N.C.
BV	2 N.O. - 2 N.C.
Time Delay	
T	1 N.O. Depress close, delayed opening
S	1 N.C. Depress open, delayed closure
Snap Action	
M	1 N.O. - 1 N.C.
N	2 N.O. - 2 N.C.
Class 1, Div. 2/Zone 2	
Logic Reed	
D1R	1 N.O.
D2R	1 N.C.
A2R	2 N.O.‡
A4R	2 N.C.
AR	1 N.O. - 1 N.C.
BR	2 N.O. - 2 N.C.

‡ A2 and A2R contact blocks cannot be stacked upon, but can stack upon other contact blocks.



Bulletin 800T/H  
**30.5 mm Push Buttons**  
 Selector Switches

2-Position Selector Switch Devices, Non-Illuminated



Standard Knob Operator  
 Cat. No. 800T-H2A



Knob Lever Operator  
 Cat. No. 800T-H17A



Standard Knob Operator  
 Cat. No. 800H-HR2A

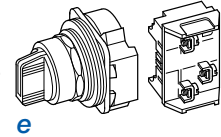
Contact Type	Side	Contact	Operator Position		M = Maintained S = Spring Return	Type 4/13		Type 4/4X/13
						Standard Knob	Knob Lever	Standard Knob
			Cat. No.	Cat. No.		Cat. No.		
No Contacts	—	—	—	—	M M	800T-H2	800T-H17	800H-HR2
					S→M	800T-H4	800T-H18	800H-HR4
					M←S	800T-H5	800T-H19	800H-HR5
1 N.O.	White	A	O	X	M M	800T-H2D1	800T-H17D1	800H-HR2D1
					S→M*	800T-H4D1	800T-H18D1	800H-HR4D1
					M←S	800T-H5D1	800T-H19D1	800H-HR5D1
1 N.O. - 1 N.C.	White	A B	O X	X O	M M	800T-H2A	800T-H17A	800H-HR2A
					S→M*	800T-H4A	800T-H18A	800H-HR4A
					M←S	800T-H5A	800T-H19A	800H-HR5A

Note: X = Closed/O = Open

\* Target tables are reversed from those shown.

800 T - HA 2 A

a                      b                      c                      d                      e



Protection Rating	
Code	Description
T	Metal, Type 4/13
H	Plastic, Type 4/4X/13

Finger-Safe Guards	
Code	Description
Blank	No guards
C	Guards on terminals

Knob Insert Colors		
800T Type 4/13	Description	800H Type 4/4X/13
Code		Code
H	White	HR
HX	Packet of colored inserts*	HRX
Metal Wing Lever Colors§		
Code	Color	Code
HA	Red	—
HG	Grey	—

Operator Type and Function	
Standard Knob	
Code	Operator Function
2	Maintained
4	Spring return from left‡
5	Spring return from right
Knob Lever§	
Code	Operator Function
17	Maintained
18	Spring return from left‡
19	Spring return from right
Metal Wing Lever§	
Code	Operator Function
11	Maintained
15	Spring return from left‡
16	Spring return from right
Coin Slot§	
Code	Operator Function
6	Maintained
7	Spring return from left
8	Spring return from right

Contact Block(s)			
Code	Contact Configuration	2-Position	
Blank	No contacts	—	—
Standard			
D1	1 N.O.	O	X
D2	1 N.C.	X	O
A	1 N.O. - 1 N.C.	O	X
		X	O
B	2 N.O. - 2 N.C.	O	X
		X	O
		O	X
		X	O
Max Duty (Horsepower Rated)*			
D1M	1 N.O.		
D2M	1 N.C.		
PenTUFF (Low Voltage)*			
D1V	1 N.O.		
D2V	1 N.C.		
AV	1 N.O. - 1 N.C.		
BV	2 N.O. - 2 N.C.		
Class1, Div. 2/Zone 2			
Logic Reed*			
D1R	1 N.O.		
D2R	1 N.C.		
AR	1 N.O. - 1 N.C.		
BR	2 N.O. - 2 N.C.		
Sealed Switch*			
D1P	1 N.O.		
D2P	1 N.C.		
AP	1 N.O. - 1 N.C.		
BP	2 N.O. - 2 N.C.		
Stackable Sealed Switch*			
D1Y	1 N.O.		
D2Y	1 N.C.		
AY	1 N.O. - 1 N.C.		
BY	2 N.O. - 2 N.C.		

10

\* One insert of each color (blue, green, orange, red, and yellow).  
 ‡ Target tables are reversed from those shown.  
 § Only available on Bul. 800T, Type 4/13 operators.  
 \* Contact target tables same as those listed for standard contact blocks.

2-Position Selector Switch Devices, Non-Illuminated (Bul. 800T only)



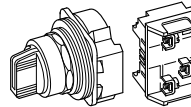
**2-Position Cylinder Lock Operator**  
 Cat. No. 800T-H33A

Contact Type	Side	Contact	Operator Position		M = Maintained S = Spring Return	Type 4/13 Cylinder Lock		
						Key Removal — Left*	Key Removal — Right*	Key Removal — Both*
						Cat. No.	Cat. No.	Cat. No.
No Contacts	—	—	—	—	M M	800T-H31	800T-H32	800T-H33
					M←S	800T-H48	—	—
1 N.O.	White	A	O	X	M M	800T-H31D1	800T-H32D1	800T-H33D1
					S→M*	—	800T-H42D1	—
					M←S	800T-H48D1	—	—
1 N.O. - 1 N.C.	White	A B	O X	X O	M M	800T-H31A	800T-H32A	800T-H33A
					S→M*	—	800T-H42A	—
					M←S	800T-H48A	—	—

Note: X = Closed/O = Open

800 T - H31 A

a      b      c      d      e



Protection Rating	
Code	Description
T	Metal, Type 4/13

Finger-Safe Guards	
Code	Description
Blank	No guards
C	Guards on terminals

Key Removal Position	
Maintained	
Code	Operator Function
H31	Key removal — left
H32	Key removal — right
H33	Key removal — both
Spring Return From Left	
Code	Operator Function
H42	Key removal — right*
Spring Return From Right	
Code	Operator Function
H48	Key removal — left

Key Options for Cylinder Locks*			
Code	T Series Key No.	Code	T Series Key No.
Blank	D018 (Std. Key)	15	T112
03	D020	16	T115
04	D025	17	T324
05	D335	18	T382
06	D429	19	T404
07	D461	20	T171
08	D111	21	T484
09	D587	22	T547
10	D682	23	T569
11	D713	24	T692
12	D900	25	T752
13	D992	26	T178
14	D118	—	—

Contact Block(s)			
Code	Contact Configuration	Description	
		2-Position	
Blank	No contacts	—	—
Standard			
D1	1 N.O.	O	X
D2	1 N.C.	X	O
A	1 N.O. - 1 N.C.	O	X
		X	O
B	2 N.O. - 2 N.C.	O	X
		X	O
		O	X
		X	O
Max Duty (Horsepower Rated)			
D1M	1 N.O.		
D2M	1 N.C.		
PenTUFF (Low Voltage)			
D1V	1 N.O.		
D2V	1 N.C.		
AV	1 N.O. - 1 N.C.		
BV	2 N.O. - 2 N.C.		
Class1, Div. 2/Zone 2			
Logic Reed§			
D1R	1 N.O.		
D2R	1 N.C.		
AR	1 N.O. - 1 N.C.		
BR	2 N.O. - 2 N.C.		
Sealed Switch§			
D1P	1 N.O.		
D2P	1 N.C.		
AP	1 N.O. - 1 N.C.		
BP	2 N.O. - 2 N.C.		
Stackable Sealed Switch§			
D1Y	1 N.O.		
D2Y	1 N.C.		
AY	1 N.O. - 1 N.C.		
BY	2 N.O. - 2 N.C.		

\* Target tables are reversed from those shown.  
 \* Keys removable from maintained positions only.  
 § Contact target tables same as those listed for standard and PenTUFF contact blocks.  
 § Device supplied with 2 keys. Replacement key part no. for standard D018 key is X-181170. See page 10-46 for additional replacement key numbers.





3-Position Selector Switch Devices, Non-Illuminated (Bul. 800T only)

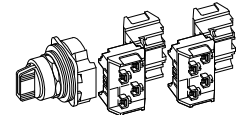


3-Position Cylinder Lock Operator  
 Cat. No. 800T-J41A

Contact Type	Operator Position			M = Maintained S = Spring Return	Type 4/13 Cylinder Lock§		
					Key Removal — Left *	Key Removal — Center *	Key Removal — All *
	Cat. No.	Cat. No.	Cat. No.		Cat. No.	Cat. No.	Cat. No.
No Contacts	—	—	—	M M M	800T-J41	800T-J42	800T-J44
				S→M M	—	800T-J50	—
				M M←S	800T-J69	800T-J38	—
				S→M←S	—	800T-J631	—
 1 N.O. - 1 N.C.	O X	O O	X O	M M M	800T-J41A	800T-J42A	800T-J44A
				S→M M	—	800T-J50A	—
				M M←S	800T-J69A	800T-J38A	—
				S→M←S	—	800T-J631A	—

Note: X = Closed/O = Open

800 T — J41 KC1 A  
 a b c d e f



**a**

Protection Rating	
Code	Description
T	Metal, Type 4/13

**b**

Finger-Safe Guards	
Code	Description
Blank	No guards
C	Guards on terminals

**c**

Key Removal Position	
Maintained	
Code	Operator Function
J41	Key removal — left
J42	Key removal — center
J43	Key removal — right
J44	Key removal — all
J45	Key removal — left and center
J46	Key removal — right and left
J47	Key removal — right and center
Spring Return from Left	
J50	Key removal — center
J52	Key removal — right
J51	Key removal — right and center

**c (cont'd)**

Key Removal Position	
Spring Return from Right	
Code	Operator Function
J69	Key removal — left
J38	Key removal — center
J73	Key removal — left and center
Spring Return from Both	
J631	Key removal — center

**d**

Key Options for Cylinder Locks§	
Code	Key No.
Blank	D018 (standard key)
03	D020
04	D025
05	D335
06	D429

Note: Refer to page 10-13 for additional key option codes.

**e**

Cam Option*	
Code	Description
Blank	KB7 cam (std.)
KA1	KA1 cam
KA7	KA7 cam
KC1	KC1 cam

Note: See Table 1 on page 10-14 for cam selections.

**e (cont'd)**

Cam Option*	
Code	Description
KC7	KC7 cam
KD7	KD7 cam
KE7	KE7 cam
KQ1	KQ1 cam
KQ7	KQ7 cam
KR1	KR1 cam
KR7	KR7 cam
KT1	KT1 cam
KT7	KT7 cam
KU7	KU7 cam

**f**

Contact Blocks	
Code	Description
Blank	No contacts
Standard	
A	1 N.O. - 1 N.C. 1-800T-XA on white side 2 N.O. - 2 N.C. 2-800T-XAs — 1 on white side/1 on black side
B	2-800T-XAs — 1 on white side/1 on black side
PenTUFF (Low Voltage)	
AV	1 N.O. - 1 N.C. 1-800T-XAV on white side
BV	2 N.O. - 2 N.C. 2-800T-XAVs — 1 on white side/1 on black side

**f (cont'd)**

Contact Blocks	
Class 1, Div. 2/Zone 2	
Logic Reed	
Code	Description
AR	1 N.O. - 1 N.C. 1-800T-XAR on white side
BR	2 N.O. - 2 N.C. 2-800T-XARs — 1 on white side/1 on black side
Sealed Switch	
AP	1 N.O. - 1 N.C. 1-800T-XAP on white side
BP	2 N.O. - 2 N.C. 2-800T-XAPs — 1 on white side/1 on black side
Stackable Sealed Switch	
AY	1 N.O. - 1 N.C. 1-800T-XAY on white side
BY	2 N.O. - 2 N.C. 2-800T-XAYs — 1 on white side/1 on black side

\* Key removable in maintained positions only.  
 \* If an overlapping cam is required, consult your local Rockwell Automation sales office or Allen-Bradley distributor.  
 § Device supplied with 2 keys. Replacement key part no. for standard D018 key is X-181170. See page 10-46 for additional replacement key numbers.



Bulletin 800T/H  
**30.5 mm Push Buttons**  
 Selector Switches

4-Position Selector Switch Devices, Non-Illuminated



Standard Knob Operator  
 Cat. No. 800T-N2KN4B



Knob Lever Operator  
 Cat. No. 800T-N17KN4B

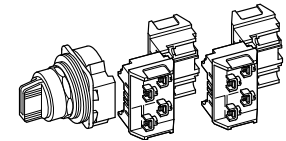


Standard Knob Operator  
 Cat. No. 800H-NR2KF4AAXX

Contact Type	Operator Position				M = Maintained S = Spring Return	Type 4/13		
						Standard Knob	Knob Lever	Type 4/4X/13
	Cat. No.			Cat. No.			Cat. No.	
No Contacts	—	—	—	—	M M M M	<b>800T-N2KF4</b>	800T-N17KF4	800H-NR2KF4
					S→M M M	800T-N3KF4	800T-N29KF4	800H-NR3KF4
					M M M←S	800T-N9KF4	800T-N30KF4	800H-NR9KF4
 2 N.O. - 2 N.C.	X	O	O	O	M M M M	<b>800T-N2KF4B</b>	<b>800T-N17KF4B</b>	<b>800H-NR2KF4AAXX</b>
	O	X	O	O	S→M M M	800T-N3KF4B	800T-N29KF4B	800H-NR3KF4AAXX
	O	O	X	X	M M M←S	800T-N9KF4B	800T-N30KF4B	800H-NR9KF4AAXX

Note: X = Closed/O = Open

800 T - N 2 KF4 B  
 a b c d e f



**a**

Protection Rating	
Code	Description
T	Metal, Type 4/13
H	Plastic, Type 4/4X/13

**b**

Finger-Safe Guards	
Code	Description
Blank	No guards
C	Guards on terminals

**c**

Knob Insert Colors		
800T Type 4/13	Description	800H Type 4/4X/13
Code		Code
N	White	NR
NX	Packet of colored inserts*	NRX
Metal Wing Lever Colors		
Code	Color	Code
NA	Red	—
NG	Grey	—

**d**

Operator Function and Knob Type	
Standard Knob	
Code	Operator Function
2	Maintained
3	Spring return from position 1 to position 2
9	Spring return from position 4 to position 3
Knob Lever§	
Code	Operator Function
17	Maintained
29	Spring return from position 1 to position 2
30	Spring return from position 4 to position 3
Metal Wing Lever§	
Code	Operator Function
11	Maintained
13	Spring return from position 1 to position 2
14	Spring return from position 4 to position 3

**e**

Cam Option*	
Code	Description
KF4	F cam
KG4	G cam
KK4	K cam
KM4	M cam
KP4	P cam
KN4	Overlapping cam*

**f**

Contact Blocks*		
800T Type 4/13	Description	800H Type 4/4X/13
Code		Code
Blank	No contacts	Blank
Standard		
B	2 N.O. - 2 N.C. 2- <b>800T-XA</b> s — 1 on white side/ 1 on black side	AAXX
H	3 N.O. - 3 N.C. 3- <b>800T-XA</b> s — 2 on white side/ 1 on black side	AAAX
C	4 N.O. - 4 N.C. 4- <b>800T-XA</b> s — 2 on white side/ 2 on black side	AAAA

**f (cont)**

Contact Blocks		
800T Type 4/13	Description	800H Type 4/4X/13
Code		Code
PenTUFF (Low Voltage)		
BV	2 N.O. - 2 N.C.	FFXX
HV	3 N.O. - 3 N.C.	FFFX
CV	4 N.O. - 4 N.C.	FFFF
Class 1, Di. 2/Zone 2		
Logic Reed‡		
BR	2 N.O. - 2 N.C.	TTXX
HR	3 N.O. - 3 N.C.	TTTX
CR	4 N.O. - 4 N.C.	TTTT
Sealed Switch‡		
BP	2 N.O. - 2 N.C.	PPXX
Stackable Sealed Switch§		
BY*	2 N.O. - 2 N.C.	TTXX
HY*	3 N.O. - 3 N.C.	TTTX
CY*	4 N.O. - 4 N.C.	TTTT

- \* One insert of each color (blue, green, orange, red, and yellow).
- † Overlapping cam. See Publication 800T-2.8 for overlap specifications.
- ‡ Contact block mounting same as listed for standard and PenTUFF contact blocks.
- § Only available on Bul. 800T, Type 4/13 operators.
- ¶ See Table 1 for proper cam/contact selection.
- ‡ Not available with wing levers.

Table 1. Cam and Contact Block Functionality Table

Contact Block Suffix Code	Contact Block Side	Circuits	Cam Codes																								
			KF4				KG4				KK4				KM4				KP4				KN4*				
C H B	White	A	X	O	O	O	X	X	O	O	O	O	X	X	X	O	O	O	O	O	O	X	O	X	O	O	
		B	O	X	O	O	O	O	X	O	X	X	O	O	X	X	O	O	X	O	O	O	O	O	O	O	X
	Black	A	O	O	O	X	X	O	O	O	X	O	O	X	O	O	X	O	O	X	O	X	X	O	O	X	O
		B	O	O	X	O	O	O	X	O	X	X	O	O	X	O	O	X	O	O	X	O	O	X	O	O	O
	White	A	X	O	O	O	X	X	O	O	O	O	X	X	X	O	O	O	O	O	O	X	O	X	O	O	O
		B	O	X	O	O	O	O	X	O	X	X	O	O	X	X	O	O	X	O	O	O	O	O	O	O	X
	Black	A	O	O	O	X	X	O	O	O	X	O	O	X	O	O	X	O	O	X	O	X	X	O	X	O	O
		B	O	O	X	O	O	O	O	X	O	X	X	O	O	X	O	O	X	O	O	X	O	O	X	O	O

Note: X = Closed/O = Open

4-Position Selector Switch Devices, Non-Illuminated (800T only)

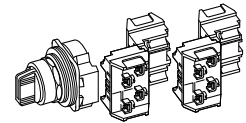


**Cylinder Lock Operator**  
 Cat. No. 800T-N32KF4B

Contact Type	Operator Position				M = Maintained S = Spring Return	Cylinder Lock – Type 4/13§		
						Key Removal — Position 2*	Key Removal — Position 3*	Key Removal — All*
					Cat. No.	Cat. No.	Cat. No.	
No Contacts	—	—	—	—	M M M M	800T-N32KF4	800T-N33KF4	<b>800T-N61KF4</b>
					S→M M M	800T-N132KF4	800T-N133KF4	—
					M M M←S	800T-N232KF4	800T-N233KF4	—
	X O O O	O X O O	O O X O	O O O X	M M M M	800T-N32KF4B	800T-N33KF4B	<b>800T-N61KF4B</b>
					S→M M M	800T-N132KF4B	800T-N133KF4B	—
					M M M←S	800T-N232KF4B	800T-N233KF4B	—

Note: X = Closed/O = Open

800 T - N31 KM4 C  
 a b c d e f



**a**

Protection Rating	
Code	Description
T	Metal, Type 4/13

**b**

Finger-Safe Guards	
Code	Description
Blank	No guards
C	Guards on terminals

**c**

Key Removal Position and Operator Function	
Maintained	
Code	Operator Function
N31	Key removal position 1
N32	Key removal position 2
N33	Key removal position 3
N34	Key removal position 4
N61	Key removal all positions

**c (cont'd)**

Key Removal Position and Operator Function	
Spring Return From Position 1 to Position 2	
Code	Description
N132	Key removal position 2
N133	Key removal position 3
N134	Key removal position 4
N154	Key removal positions 2, 3, and 4
Spring Return From Position 4 to Position 3	
Code	Operator Function
N231	Key removal position 1
N232	Key removal position 2
N233	Key removal position 3
N251	Key removal positions 1, 2, and 3

**d**

Key Options for Cylinder Locks§	
D Series	
Code	Key No.
Blank	D018 (standard key)
03	D020
04	D025
05	D335
06	D429

Note: Refer to page 10-13 for additional key option codes.

**e**

Cam Option	
Code	Description
KF4	F cam
KG4	G cam
KK4	K cam
KM4	M cam
KP4	P cam
KN4	Overlapping cam*

Note: See Table 1 for proper cam selection.

**f**

Contact Blocks	
Code	Description
Blank	No contacts
Standard	
B	2 N.O. - 2 N.C. 2-800T-XAs — 1 on white side/1 on black side
H	3 N.O. - 3 N.C. 3-800T-XAs — 2 on white side/1 on black side
C	4 N.O. - 4 N.C. 4-800T-XAs — 2 on white side/2 on black side
PenTUFF (Low Voltage)	
BV	2 N.O. - 2 N.C. 2-800T-XAVs — 1 on white side/1 on black side
HV	3 N.O. - 3 N.C. 3-800T-XAVs — 2 on white side/1 on black side
CV	4 N.O. - 4 N.C. 4-800T-XAVs — 2 on white side/2 on black side
Class 1, Div. 2/Zone 2	
Logic Reed†	
BR	2 N.O. - 2 N.C.
HR	3 N.O. - 3 N.C.
CR	4 N.O. - 4 N.C.
Sealed Switch‡	
BP	2 N.O. - 2 N.C.
Stackable Sealed Switch‡	
BY	2 N.O. - 2 N.C.
HY	3 N.O. - 3 N.C.
CY	4 N.O. - 4 N.C.

Note: Associated targets shown in Table 1.

Table 1. Cam and Contact Block Functionality Table

Contact Block Suffix Code	Contact Block Side	Circuits	Cam Codes																							
			KF4				KG4				KK4				KM4				KP4				KN4*			
C	White	A	X	O	O	O	X	X	O	O	O	O	X	X	X	O	O	O	O	O	X	O	X	O	O	
		B	O	X	O	O	O	O	X	O	X	X	O	O	O	X	X	O	O	X	O	O	O	O	O	X
	Black	A	O	O	O	X	X	O	O	O	X	O	O	X	O	O	X	O	O	X	X	O	O	X	O	O
		B	O	O	X	O	O	O	O	X	O	X	X	O	O	X	O	O	X	O	O	X	O	O	O	O
	White	A	X	O	O	O	X	X	O	O	O	O	X	X	X	O	O	O	O	X	O	O	X	O	O	O
		B	O	X	O	O	O	O	X	O	X	X	O	O	O	X	O	O	X	O	O	O	O	O	O	X
	Black	A	O	O	O	X	X	O	O	O	X	O	O	X	O	O	X	O	O	X	X	O	O	X	O	O
		B	O	O	X	O	O	O	O	X	O	X	X	O	O	X	O	O	X	O	O	X	O	O	O	O

Note: X = Closed/O = Open

\* Key removable in maintained positions only.

† Overlapping cam. One layer of contact blocks allowed, no stacking. See Publication 800T-2.8 for overlap specifications.

‡ Contact block mounting same as listed for standard and PenTUFF contact blocks.

§ Device supplied with 2 keys. Replacement key part no. for standard D018 key is X-181170. See page 10-46 for additional replacement key numbers.

Bulletin 800T/H  
**30.5 mm Push Buttons**  
 Selector Switches

2-Position Knob/Lever Type Selector Switch Devices, Illuminated



Standard Knob Operator  
 Cat. No. 800T-16HR2KB6AX



Knob Lever Operator  
 Cat. No. 800H-16HRR17KB6AX

Type	Lamp Type	Volts	Knob Color	Operator Position		M = Maintained S = Spring Return	Type 4/13	Type 4/4X/13
							Standard Knob	Standard Knob
Operator Only*				No Contacts			Cat. No.	Cat. No.
Full Voltage	Incandescent	24V AC/DC	Red	X	O	M M	800T-00HX2KB6	800H-00HRRX2KB6
						M M	<b>800T-24HR2KB6AX</b>	800H-24HRR2KB6AX
	S→M*	800T-24HR4KL8AX	800H-24HRR4KL8AX					
	M←S	800T-24HR5KL8AX	800H-24HRR5KL8AX					
Universal	No Lamp	0...250V AC/DC	No Knob	O	X	M M	800T-25HXN2KB6AX	800H-25HRRN2KB6AX
						M M	<b>800T-2HRH2KB6AX</b>	800H-2HRRH2KB6AX
	S→M*	800T-2HRH4KL8AX	800H-2HRRH4KL8AX					
	M←S	800T-2HRH5KL8AX	800H-2HRRH5KL8AX					
Transformer	Incandescent	120V AC 50/60 Hz	Red	X	O	M M	<b>800T-16HR2KB6AX</b>	<b>800H-16HRR2KB6AX</b>
						S→M*	800T-16HR4KL8AX	800H-16HRR4KL8AX
						M←S	800T-16HR5KL8AX	800H-16HRR5KL8AX
						M M	<b>800T-16HRH2KB6AX</b>	800H-16HRRH2KB6AX
	S→M*	800T-16HRH4KL8AX	800H-16HRRH4KL8AX					
	M←S	800T-16HRH5KL8AX	800H-16HRRH5KL8AX					
	No Lamp	120V AC 50/60 Hz	No Knob			M M	800T-16HXN2KB6AX	800H-16HRXN2KB6AX

Note: X = Closed/O = Open

\* Operator only supplied without power module, lamp, lens cap, or contact blocks.

\* Target tables are reversed from those shown.

800 T - 16 H R 2 KB6 A X

1st Level    2nd Level

Protection Rating	
Code	Description
T	Metal, Type 4/13
H	Plastic, Type 4/4X/13

Finger-Safe Guards	
Code	Description
Blank	No guards
C	Guards on terminals

Power Module Type and Voltage	
Full Voltage — Incandescent	
Code	Description
12	12V AC/DC
24	24V AC/DC
48	48V AC/DC
Universal — LED	
2	12...130V AC/DC
Transformer	
16	120V AC 50/60 Hz
26	240V AC 50/60 Hz

For other voltages, please contact your local Rockwell Automation sales office or Allen-Bradley distributor.

No. of Positions		
Bul. 800T Type 4/13	Description	Bul. 800H Type 4/4X/13
Code		Code
H	2-position	HR

Knob Color	
Code	Color
A	Amber
B	Blue
C	Clear
G	Green
R	Red
W	White
X	No knob

Illumination Options	
Code	Description
Blank	Incandescent
H	LED

**Table 1. Selector Switch Cam Targets**

Cam Description (2-Position)		Contact Block Code*
Target		
		D, H, V, R, 5 E, U, W, S, 6
O	X	
X	O	

X = Closed/O = Open

Operator Function and Knob Type	
Standard Knob or No Knob	
Code	Operator Function
2	Maintained
4	Spring return from left
5	Spring return from right
Knob Lever	
17	Maintained
18	Spring return from left
19	Spring return from right

Cam Options	
2-Position	
Code	Operator Function
KB6	Maintained Cam
KL8	Spring Return Cam

**Table 2. Contact Block Code Reduction Rules**

Contact Block Substitution	
Combination	Code
Standard	
D + E	A
D + D	M
E + E	N

Contact Blocks*	
Code	Description
Blank (both pos.)	No contacts
Standard	
D	1 N.O.
E	1 N.C.
A	1 N.O. - 1 N.C.
X	No contacts in this position
PenTUFF (Low Voltage)	
H	1 N.O.
U	1 N.C.
F	1 N.O. - 1 N.C.
Class 1, Div. 2/Zone 2	
Logic Reed	
V	1 N.O.
W	1 N.C.
T	1 N.O. - 1 N.C.
Sealed Switch	
R	1 N.O.
S	1 N.C.
P	1 N.O. - 1 N.C.
Stackable Sealed Switch	
5	1 N.O.
6	1 N.C.
7	1 N.O. - 1 N.C.

\* Contact blocks used on white side only.

\* Target tables are reversed for spring return from left operators.

3-Position Knob/Lever Type Selector Switch Devices, Illuminated



Standard Knob Operator  
 Cat. No. 800T-16JR2KB7AX

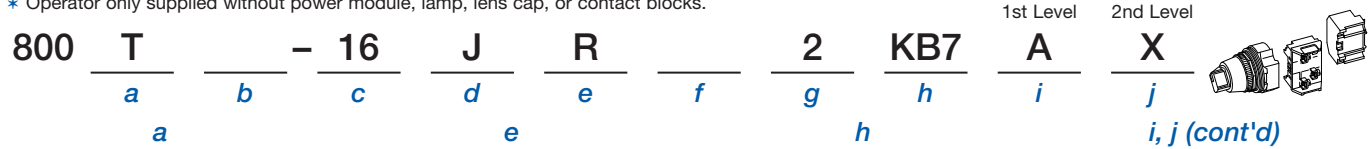


Standard Knob Operator  
 Cat. No. 800H-16JRR2KB7AX

Type	Lamp Type	Volts	Color	Operator Position			M = Maintained S = Spring Return	Type 4/13	Type 4/4X/13			
								Standard Knob	Standard Lever			
Operator Only*				No Contacts			Cat. No.	Cat. No.				
Full Voltage	Incandescent	24V AC/DC	Red	X O	O O	O X	M M M	800T-00JX2KB7	—			
							M M M	800T-24JR2KB7AX	800H-24JRR2KB7AX			
	S→M M	800T-24JR4KB7AX	800H-24JRR4KB7AX									
	M M←S	800T-24JR5KB7AX	800H-24JRR5KB7AX									
Universal	LED	12...130V AC/DC	Red	X O	O O	O X	M M M	800T-25JXN2KB7AX	—			
							M M M	800T-2JRH2KB7AX	800H-2JRRH2KB7AX			
							S→M M	800T-2JRH4KB7AX	800H-2JRRH4KB7AX			
							M M←S	800T-2JRH5KB7AX	800H-2JRRH5KB7AX			
Transformer	Incandescent	120V AC 50/60 Hz	Red	X O	O O	O X	M M M	<b>800T-16JR2KB7AX</b>	<b>800H-16JRR2KB7AX</b>			
							S→M M	800T-16JR4KB7AX	800H-16JRR4KB7AX			
							M M←S	800T-16JR5KB7AX	800H-16JRR5KB7AX			
							M M M	800T-16JRH2KB7AX	800H-16JRRH2KB7AX			
	LED	120V AC 50/60 Hz	Red				X O	O O	O X	S→M M	800T-16JRH4KB7AX	800H-16JRRH4KB7AX
										M M←S	800T-16JRH5KB7AX	800H-16JRRH5KB7AX
										M M M	800T-16JXN2KB7AX	—
										M M M	800T-16JXN2KB7AX	—

Note: X = Closed/O = Open

\* Operator only supplied without power module, lamp, lens cap, or contact blocks.



**a**

Protection Rating	
Code	Description
T	Metal, Type 4/13
H	Plastic, Type 4/4X/13

**b**

Finger-Safe Guards	
Code	Description
Blank	No guards
C	Guards on terminals

**c**

Power Module Type and Voltage	
Full Voltage — Incandescent	
Code	Description
12	12V AC/DC
24	24V AC/DC
48	48V AC/DC
Universal — LED	
2	12...130V AC/DC
Transformer	
16	120V AC 50/60 Hz
26	240V AC 50/60 Hz

For other voltages, please contact your local Rockwell Automation sales office or Allen-Bradley distributor.

**d**

No. of Positions		
800T Type 4/13	Description	800H Type 4/4X/13
Code		Code
J	3-position	JR

**e**

Knob Color	
Code	Color
A	Amber
B	Blue
C	Clear
G	Green
R	Red
W	White
X	No knob

**f**

Illumination Options	
Code	Description
Blank	Incandescent
H	LED†

**g**

Operator Function and Knob Type	
Standard Knob or No Knob	
Code	Operator Function
2	Maintained
4	Spring return from left
5	Spring return from right
91	Spring return from both
Knob Lever	
Code	Operator Function
17	Maintained
18	Spring return from left
19	Spring return from right
20	Spring return from both

‡ LED only.

† LEDs available in red, green, amber, blue, and white. White LEDs only available in 6V, 24V, 120V, and 130V full voltage and all transformer units. LED color matches lens color, except clear lens supplied with white LED and white lens supplied with amber LED. All LEDs except 120V have an internal shunt resistor for use with solid-state outputs.

§ Contact blocks used on white side only.

**h**

Cam Options	
3-Position	
Code	Operator Function
KB7	B7 cam
KC1	C1 cam
KC7	C7 cam
KE7	E7 cam
KQ1	Q1 cam
KT1	T1 cam

**i, j**

Contact Blocks§	
Code	Description
Blank (both pos.)	No contacts

**i, j (cont'd)**

Contact Blocks§	
Code	Description
Standard	
A	1 N.O. - 1 N.C.
X	No contacts in this position
PenTUFF (Low Voltage)	
F	1 N.O. - 1 N.C.
Class 1, Div. 2/Zone 2	
Logic Reed	
T	1 N.O. - 1 N.C.
Sealed Switch	
P	1 N.O. - 1 N.C.
Stackable Sealed Switch	
7	1 N.O. - 1 N.C.

Table 1. Selector Switch Cam Targets

Target			Cam Description (3-Position)					
			KB7	KC1	KC7	KE7	KQ1	KT1
X	O	O	D, H, V, R, 5	—	D, H, V, R, 5	D, H, V	—	E, U, W, S, 6
O	X	O	—	E, U, W, S, 6	E, U, W, S, 6	—	E, U, W, S, 6	—
O	O	X	E, U, W, S, 6	D, H, V, R, 5	—	—	—	D, H, V, R, 5
X	X	O	G, I	J, Q	—	—	—	J, Q
O	X	X	J, Q	—	J, Q	E, U, W, S, 6	—	—
X	O	X	—	G, I	G, I	—	D, H, V, R, 5	—

Bulletin 800T/H  
**30.5 mm Push Buttons**  
 Pilot Lights

Pilot Light Devices\*



Transformer Type Pilot Light  
 Cat. No. 800T-P16R



Push-to-Test Pilot Light  
 Cat. No. 800T-PT16R

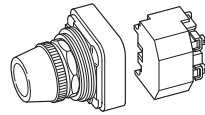
Type	Lamp Type	Volts	Color	Type 4/13		Type 4/4X/13	
				Pilot Light	Push-to-Test*	Pilot Light	Push-to-Test*
				Cat. No.	Cat. No.	Cat. No.	Cat. No.
Operator Only*				800T-S00	800T-SB00XX	800H-SR00	800H-SRB00XX
Full Voltage†	Incandescent	24V AC/DC	Red	800T-Q24R	800T-QT24R	800H-QR24R	800H-QRT24R
			Green	800T-Q24G	800T-QT24G	800H-QR24G	800H-QRT24G
			Amber	800T-Q24A	800T-QT24A	800H-QR24A	800H-QRT24A
	No Lamp	0...250V AC/DC	No Lens	800T-QN25	800T-QTN25	—	—
Universal†	LED	12...130 V AC/DC	Red	800T-QH2R	800T-QTH2R	800H-QRH2R	800H-QRTH2R
			Green	800T-QH2G	800T-QTH2G	800H-QRH2G	800H-QRTH2G
			Amber	800T-QH2A	800T-QTH2A	800H-QRH2A	800H-QRTH2A
Transformer†	Incandescent	120V AC, 50/60 Hz	Red	800T-P16R	800T-PT16R	800H-PR16R	800H-PRT16R
			Green	800T-P16G	800T-PT16G	800H-PR16G	800H-PRT16G
			Amber	800T-P16A	800T-PT16A	800H-PR16A	800H-PRT16A
	LED		Red	800T-PH16R	800T-PTH16R	800H-PRH16R	800H-PRTH16R
			Green	800T-PH16G	800T-PTH16G	800H-PRH16G	800H-PRTH16G
			Amber	800T-PH16A	800T-PTH16A	800H-PRH16A	800H-PRTH16A
			No Lamp	No Lens	800T-PN16	800T-PTN16	—

\* Includes one standard Cat. No. 800T-XA (1 N.O. - 1 N.C.) contact block. For typical pilot light wiring diagrams, see page 10-65.

\* Operator only supplied without power module, lamp, lens cap, or contact blocks.

† All pilot lights except push-to-test without sealed contacts and dual input transformer relay, are rated for Class 1, Division 2 applications.

800 T - P T 16 G AR (Push-to-Test)  
 a b c d e f g h



**a**

Protection Rating	
Code	Description
T	Metal, Type 4/13
H	Plastic, Type 4/4X/13

**b**

Finger-Safe Guards	
Code	Description
Blank	No guards
C	Guards on terminals

**c**

Power Module Type		
800T Type 4/13	Description	800H Type 4/4X/13
Code		Code
P	Transformer (or dual input)	PR
Q	Full voltage/ Universal	QR

**d**

Lamp Test Options	
Code	Description
Blank	No test option
T	Push-to-test
D	Dual input — diode*
DT	Dual input — transformer relay

**Note:** Push-to-test supplied with factory jumpered contact block.

**e**

Illumination Options	
Code	Description
Blank	Incandescent
H	LED*

**f**

Voltage	
Transformer	
Code	Description
16	120V AC 50/60 Hz
26	240V AC 50/60 Hz
46	480V AC 50/60 Hz
56	600V AC 50/60 Hz
Full Voltage — Incandescent	
12	12V AC/DC
24	24V AC/DC
48	48V AC/DC
10	120V AC/DC
20	240V AC/DC
Universal — LED	
2	12...130V AC/DC
Dual Input	
16	120V AC
24	24V AC/DC (Dual input diode only)

**g**

Lens Color		
Code	Color	Glass Code
Blank	No lens	Blank
A	Amber	D
B	Blue	E
C	Clear	F
G	Green	H
R	Red	J
W	White	K

**h**

Contact Blocks (Push-to-test units only)	
Code	Description
Standard	
Blank	1 N.O. - 1 N.C.
PenTUFF (Low Voltage)	
AV	1 N.O. - 1 N.C.
Class 1, Div. 2/Zone 2	
Logic Reed	
AR	1 N.O. - 1 N.C.
Sealed Switch	
AP	1 N.O. - 1 N.C.
Stackable Sealed Switch	
AY	1 N.O. - 1 N.C.

- \* LED illumination option is not available with diode type dual input.
- \* Diode type dual input provides circuit isolation via opposing diodes. Not recommended for use with solid-state outputs.
- \* Glass lens available on 800T pilot lights only. Not available on push-to-test units.



**2-Position Red Push-Pull and Push-Pull/Twist Release Devices, Non-Illuminated**

**Note:** A jumbo or large legend plate is recommended, if space allows.



2-Position Push-Pull  
 Cat. No. 800T-FX6D4



2-Position Metal Push-Pull  
 Cat. No. 800T-FXLE6D4S



2-Position Push-Pull / Twist  
 Cat. No. 800T-FXT6D4



2-Position Push-Pull / Twist  
 Cat. No. 800H-FRXT6D4

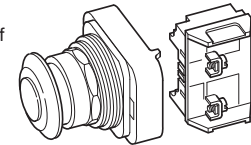
Contact Type	Operator Position		Type 4/13			Type 4/4X/13
			Push-Pull — 40 mm	Push-Pull — 63 mm Metal	Push-Pull/Twist Release	Push-Pull/Twist Release
	Out	In	Cat. No.	Cat. No.	Cat. No.	Cat. No.
N.C.L.B.*	X	O	<b>800T-FX6D4</b>	<b>800T-FXLE6D4</b>	<b>800T-FXT6D4</b>	<b>800H-FRXT6D4</b>
N.O. - N.C.L.B.*	O	X	<b>800T-FX6A1</b>	<b>800T-FXLE6A1</b>	<b>800T-FXT6A1</b>	<b>800H-FRXT6A1</b>
N.C.L.B. - N.C.L.B.*	X	O	<b>800T-FX6A5</b>	<b>800T-FXLE6A5</b>	<b>800T-FXT6A5</b>	<b>800H-FRXT6A5</b>
S.M.C.B.*†	X	O	<b>800TC-FX6D4S</b>	<b>800TC-FXLE6D4S</b>	<b>800TC-FXT6D4S</b>	<b>800HC-FRXT6D4S</b>
N.O. - S.M.C.B.*†	O	X	<b>800TC-FX6A1S</b>	<b>800TC-FXLE6A1S</b>	<b>800TC-FXT6A1S</b>	<b>800HC-FRXT6A1S</b>
S.M.C.B. - S.M.C.B.*†	X	O	<b>800TC-FX6A5S</b>	<b>800TC-FXLE6A5S</b>	<b>800TC-FXT6A5S</b>	<b>800HC-FRXT6A5S</b>

**Note:** X = Closed/O = Open

**Note:** These caps are only available in plastic.

**Note:** Emergency stop push buttons are compliant with EN ISO 13850 and EN/IEC 60947-5-5 Standards when using N.C.L.B. contact blocks.

\* The Self Monitoring Contact Block (S.M.C.B.) is composed of a N.C.L.B. contact wired in series with a N.O. monitoring contact. The N.O. monitoring contact automatically closes when the S.M.C.B. is properly installed onto the E-stop operator. If the S.M.C.B. is separated from the E-stop operator, the N.O. monitoring contact will automatically open.



**800 T - FX 1 A1**

a                      b                      c                      d                      e

Protection Rating	
Code	Description
T	Metal, Type 4/13
H	Plastic, Type 4/4X/13

Finger-Safe Guards	
Code	Description
Blank	No guards
C	Guards on terminals

Head Type†		
800T Type 4/13	Description	800H Type 4/4X/13
Code		Code
FX	Mushroom head (push-pull)	—
FXC	90 mm anodized aluminum head (push-pull)	—
FXJ	Jumbo mushroom head (push-pull)	—
FXJE	Jumbo mushroom head (push-pull) with "E-Stop"	—
FXL	63 mm anodized aluminum head (push-pull)	—
FXLE	63 mm anodized aluminum head (push-pull) with "E-Stop"	—
FXT	Push-pull/twist-to-release	FRXT
FXJT	Jumbo head push-pull with twist-to-release	FRXJT

Color Cap	
Code	Color
Blank	No cap§
1	Green
2	Black
3	Orange
4	Grey
5	White
6	Red
7	Blue
9	Yellow

Contact Block(s)				
Code	Operator Position		Description	
Blank	—	—	No contacts on operator	
Standard				
D1	O	X	1 N.O.	
D2	X	O	1 N.C.	
D4	X	O	1 N.C.L.B.	
A	O	X	1 N.O. - 1 N.C.	
A1	O	X	1 N.O. - 1 N.C.L.B.	
A5	X	O	2 N.C.L.B.	

Contact Block(s)			
Code	Operator Position		Description
Blank	—	—	No contacts
PenTUFF (Low Voltage)			
D1V	O	X	1 N.O.
D2V	X	O	1 N.C.
D4V	X	O	1 N.C.L.B.
AV	O	X	1 N.O. - 1 N.C.
X	X	O	
Class 1, Div. 2/Zone 2			
Logic Reed			
D1R	O	X	1 N.O.
D2R	X	O	1 N.C.
AR	O	X	1 N.O. - 1 N.C.
X	X	O	
Sealed Switch			
D1P	O	X	1 N.O.
D2P	X	O	1 N.C.
AP	O	X	1 N.O.
X	X	O	1 N.C.
Stackable Sealed Switch			
D1Y	O	X	1 N.O.
D2Y	X	O	1 N.C.
AY	O	X	1 N.O. - 1 N.C.
X	X	O	

**Note:** X = Closed/O = Open

\* Normally closed late break contact. When button is pushed from the OUT to IN position, the mechanical detent action of the operator occurs before electrical contacts change state. When the button is pulled from the IN in the OUT position, the electrical contacts change state before the mechanical detent occurs.

† Devices with N.C.L.B. contacts meet EN ISO 13850 and IEC 60947-5-5 standards for emergency stop applications.

§ Not valid with head Type J or JT.

Bulletin 800T/H  
**30.5 mm Push Buttons**  
 Push-Pull Operators

**3-Position Push-Pull Devices, Non-Illuminated**

**Note:** A jumbo or large legend plate is recommended, if space allows.



3-Position Push-Pull  
 Cat. No. 800T-FXM6A7



3-Position Push-Pull  
 Cat. No. 800H-FRXM6A7

Contact Type	Operator Position			Operator Position		
	Momentary	Maintained	Maintained	Momentary	Maintained	Momentary
	Out	Center	In	Out	Center	In
N.C.-	X	O	O	X	O	O
N.C.L.B.*	X	X	O	X	X	O

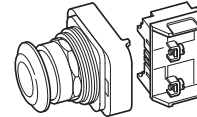
Button Color	Type 4/13	Type 4/4X/13	Type 4/13	Type 4/4X/13
	Push-Pull*	Push-Pull*	Push-Pull*	Push-Pull*
	Cat. No.	Cat. No.	Cat. No.	Cat. No.
Red	<b>800T-FXM6A7</b>	<b>800H-FRXM6A7</b>	<b>800T-FXN6A7</b>	<b>800H-FRXN6A7</b>

**Note:** X = Closed/O = Open

\* Normally closed late break contact. When button is pushed from the OUT to IN position, the mechanical detent action of the operator occurs before electrical contacts change state. When the button is pulled from the IN to the OUT position, the electrical contacts change state before the mechanical detent occurs.

\* Devices with N.C.L.B. contacts meet EN ISO 13850 and IEC 60947-5-5 standards for emergency stop applications.

**800**   **T**   **- FX**   **M**   **1**   **A7**  
           **a**        **b**        **c**        **d**        **e**        **f**



**a**

Protection Rating	
Code	Description
T	Metal, Type 4/13
H	Plastic, Type 4/4X/13

**b**

Finger-Safe Guards	
Code	Description
Blank	No guards
C	Guards on terminals

**c**

Head Type*		
800T Type 4/13	Description	800H Type 4/4X/13
Code		Code
FX	Mushroom head (push-pull)	FRX
FXC	90 mm anodized aluminum head (push-pull)	—
FXJ	Jumbo mushroom head (push-pull)	FRXJ
FXL	63 mm anodized aluminum head (push-pull)	—

**d**

Operator Function			
Code	Operator Position		
	Out	Center	In
M	Momentary	Maintained	Maintained
N	Momentary	Maintained	Momentary

**e**

Color Cap	
Code	Color
Blank	No cap†
1	Green
2	Black
3	Orange
4	Grey
5	White
6	Red
7	Blue
9	Yellow

**f**

Contact Block(s)				
Code	Operator Position			Description
	Out	Ctr.	In	
Blank	—	—	—	No contacts
Standard				
A	O	O	X	1 N.O. - 1 N.C.
	X	O	O	
A1	O	O	X	1 N.O. - 1 N.C.L.B.
	X	X	O	
A7	X	O	O	1 N.C. - 1 N.C.L.B.
	X	X	O	
B6	X	O	O	2 N.C. - 2 N.C.L.B.
	X	X	O	
	X	O	O	
	X	X	O	
PenTUFF (Low Voltage)				
AV	O	O	X	1 N.O. - 1 N.C.
	X	O	O	

**f (cont'd)**

Contact Block(s)				
Code	Operator Position			Description
	Out	Ctr.	In	
Class 1, Div. 2/Zone 2				
Logic Reed				
AR	O	O	X	1 N.O. - 1 N.C.
	X	O	O	
Sealed Switch				
AP	O	O	X	1 N.O. - 1 N.C.
	X	O	O	
Stackable Sealed Switch				
AY	O	O	X	1 N.O. - 1 N.C.
	X	O	O	

**Note:** X = Closed/O = Open

\* Devices with N.C.L.B. contacts meet EN ISO 13850 and IEC 60947-5-5 standards for emergency stop applications.

† Not valid with head Type J.



**2-Position Red Push-Pull and Push-Pull/Twist Release Devices, Illuminated**

Note: A jumbo or large legend plate is recommended, if space allows.



Illuminated 2-Position Push-Pull  
 Cat. No. 800T-FXP16RA1



2-Position Push-Pull  
 Cat. No. 800T-FXJEP16RA1



Illuminated 2-Position Push-Pull/Twist  
 Cat. No. 800T-FXTP16RA1



Illuminated 2-Position Push-Pull/Twist  
 Cat. No. 800H-FRXT16RA1

Type	Lamp Type	Volts	Color	Contacts	Operator Position		Type 4/13			Type 4/4X/13
					Out	In	Push-Pull — 40 mm❖	Push-Pull — 60 mm with "E-Stop"❖	Push-Pull/Twist Release❖	Push-Pull/Twist Release❖
Operator Only*					No Contacts		800T-FXS00X	—	800T-FXTS00X	800H-FRXTS00X
Full Voltage	Incan.	24V AC/DC	Red	N.O. - N.C.L.B. ❖	O	X	800T-FXQ24RA1	800T-FXJEQ24RA1	800T-FXTQ24RA1	800H-FRXTQ24RA1
	No Lamp	0...250V AC/DC	No Lens				800T-FXQN25XA1	—	800T-FXTQN25XA1	800H-FRXTQN25XA1
Universal	LED	12...130V AC/DC	Red	❖	O	X	800T-FXQH2RA1	800T-FXJEQH2RA1	800T-FXTQH2RA1	800H-FRXTQH2RA1
Transformer	Incan.	120V AC	Red	N.O. - N.C.L.B. ❖	O	X	800T-FXP16RA1	800T-FXJEP16RA1	800T-FXTP16RA1	800H-FRXT16RA1
		240V AC					800T-FXP26RA1	800T-FXJEP26RA1	800T-FXTP26RA1	800H-FRXT26RA1
	120V AC	800T-FXPH16RA1					800T-FXJEPH16RA1	800T-FXTPH16RA1	800H-FRXTPH16RA1	
	240V AC	800T-FXPH26RA1					800T-FXJEPH26RA1	800T-FXTPH26RA1	800H-FRXTPH26RA1	
Transformer	No Lamp	120V AC	No Lens	❖	O	X	800T-FXPN16XA1	—	800T-FXTPN16XA1	800H-FRXTPN16XA1

Note: X = Closed/O = Open      Note: Emergency stop push buttons are compliant with EN ISO 13850 and EN/IEC 60947-5-5 Standards when using N.C.L.B. contact blocks.

\* Operator only supplied without power module, lamp, lens cap, or contact blocks.

❖ Normally closed late break contact. When button is pushed from the OUT to IN position, the mechanical detent action of the operator occurs before electrical contacts change state. When the button is pulled from the IN to the OUT position, the electrical contacts change state before the mechanical detent occurs.

❖ Consult your local Rockwell Automation sales office or Allen-Bradley distributor for availability of illuminated E-stops with Self Monitoring Contact Blocks (SMCBs).

**800 T - FX T PH 16 R A1**

a b c d e e f g h

Protection Rating	
Code	Description
T	Metal, Type 4/13
H	Plastic, Type 4/4X/13

Finger-Safe Guards	
Code	Description
Blank	No guards
C	Guards on terminals

Head Type§		
800T Type 4/13	Description	800H Type 4/4X/13
Code		Code
FX	Mushroom head	FRX
FXJ	Jumbo mushroom	FRXJ
FXJE	Jumbo mushroom (push-pull) with "E-Stop"	—

Operator Function	
Code	Description
Blank	Push-pull▲
T	Push-pull/twist

Illumination Options	
Transformer	
Code	Description
P	Incandescent
PH	LED
Full Voltage	
Q	Incandescent
QH	Universal LED
Dual Input	
D	Diode type
DT	Transformer — relay type
DTH	Transformer — relay type LED

Voltage‡	
Transformer	
Code	Description
16	120V AC 50/60 Hz
26	240V AC 50/60 Hz
Full Voltage	
24	24V AC/DC
10	120V AC/DC
20	240V AC/DC
Universal LED	
2	12...130V AC/DC
Dual Input	
16	120V AC
24	24V AC/DC (dual input diode only)

Color Cap	
Code	Color
X	No cap (not valid with head Type J)
A	Amber
B	Blue
C	Clear
G	Green
R	Red
W	White

Target		
Contact		
N.O.	O	X
N.C./N.C.L.B.	X	O

Contact Blocks	
Code	Description
Blank	No contacts
Standard	
D1	1 N.O.
D2	1 N.C.
D4	1 N.C.L.B.
A	1 N.O. - 1 N.C.
A1	1 N.O. - 1 N.C.L.B.
A5	2 N.C.L.B.
PenTUFF (Low Voltage)	
D1V	1 N.O.
D2V	1 N.C.
D4V	1 N.C.L.B.
AV	1 N.O. - 1 N.C.

h (cont'd)

Contact Blocks	
Code	Description
Class 1, Div. 2/Zone 2	
Logic Reed	
D1R	1 N.O.
D2R	1 N.C.
AR	1 N.O. - 1 N.C.
Sealed Switch	
D1P	1 N.O.
D2P	1 N.C.
AP	1 N.O. - 1 N.C.
Stackable Sealed Switch	
D1Y	1 N.O.
D2Y	1 N.C.
AY	1 N.O. - 1 N.C.

‡ See page 10-20 for additional voltage code options.

§ Devices with N.C.L.B. contacts meet EN ISO 13850 and IEC 60947-5-5 standards for emergency stop applications.

▲ Push-Pull is available only with Bul. 800T.

⚡ Diode type dual input provides circuit isolation via opposing diodes. Not recommended for use with solid-state outputs.

Bulletin 800T/H  
**30.5 mm Push Buttons**  
 Push-Pull Operators

3-Position Push-Pull Devices, Illuminated



Illuminated 3-Position Push-Pull  
 Cat. No. 800T-FXMP16RA7



Illuminated 3-Position Push-Pull  
 Cat. No. 800H-FRXMP16A7

	Operator Position			Operator Position		
	Momentary	Maintained	Maintained	Momentary	Maintained	Momentary
Contacts	Out	Center	In	Out	Center	In
N.C.-	X	O	O	X	O	O
N.C.L.B.*	X	X	O	X	X	O

Type	Lamp Type	Volts	Color	Type 4/13	Type 4/4X/13	Type 4/13	Type 4/4X/13
				Cat. No.‡	Cat. No.‡	Cat. No.‡	Cat. No.‡
Operator Only*				800T-FXMS00X	800H-FRXMS00X	800T-FXNS00X	800H-FRXNS00X
Full Voltage	Incandescent	24V AC/DC	Red	<b>800T-FXMQ24RA7</b>	800H-FRXMQ24RA7	<b>800T-FXNQ24RA7</b>	800H-FRXNQ24RA7
	No Lamp	0...250V AC/DC	No Lens	800T-FXMQN25XA7	800H-FRXMQN25XA7	800T-FXNQN25XA7	800H-FRXNQN25XA7
Universal	LED	12...130V AC/DC	Red	<b>800T-FXMQH2RA7</b>	800H-FRXMQH2RA7	<b>800T-FXNQH2RA7</b>	800H-FRXNQH2RA7
Transformer	Incandescent	120V AC	Red	<b>800T-FXMP16RA7</b>	<b>800H-FRXMP16RA7</b>	<b>800T-FXNP16RA7</b>	<b>800H-FRXNP16RA7</b>
	LED	120V AC		<b>800T-FXMPH16RA7</b>	800H-FRXMPH16RA7	800T-FXNPH16RA7	800H-FRXNPH16RA7
	No Lamp	120V AC	No Lens	800T-FXMPN16XA7	800H-FRXMPN16XA7	800T-FXNPN16XA7	800H-FRXNPN16XA7

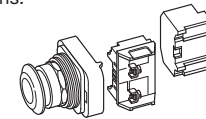
Note: X = Closed/O = Open

\* Normally closed late break contact. When button is pushed from the OUT to IN position, the mechanical detent action of the operator occurs before electrical contacts change state. When the button is pulled from the IN to the OUT position, the electrical contacts change state before the mechanical detent occurs.

\* Operator only supplied without power module, lamp, lens cap, or contact blocks.

‡ Devices with N.C.L.B. contacts meet EN ISO 13850 and EN/IEC 60947-5-5 standards for emergency stop applications.

**800 T - FX M PH 16 R A1**  
 a b c d e f g h



**a**

Protection Rating	
Code	Description
T	Metal, Type 4/13
H	Plastic, Type 4/4X/13

**b**

Finger-Safe Guards	
Code	Description
Blank	No guards
C	Guards on terminals

**c**

Head Type‡		
800T Type 4/13	Description	800H Type 4/4X/13
Code		Code
FX	Mushroom head	FRX
FXJ	Jumbo mushroom	FRXJ

**d**

Operator Function			
Code	Operator Position		
M	Mom.	Main.	Main.
N	Mom.	Main.	Mom.
Mom. – Momentary, Main. – Maintained.			

**e**

Illumination Options	
Transformer	
Code	Description
P	Incandescent
PH	LED
Full Voltage	
Q	Incandescent
QH	Universal LED
Dual Input	
D	Diode type
DT	Transformer — relay type
DTH	Transformer — relay LED

**f**

Voltage§	
Transformer	
Code	Description
16	120V AC 50/60 Hz
26	240V AC 50/60 Hz
Full Voltage	
24	24V AC/DC
10	120V AC/DC
20	240V AC/DC
Universal LED	
2	12...130V AC/DC
Dual Input	
16	120V AC
24	24V AC/DC▲

**g**

Color Cap	
Code	Color
X	No cap (not valid with head Type J)
A	Amber
B	Blue
C	Clear
G	Green
R	Red
W	White

**h**

Target			
Contact			
N.O.	O	O	X
N.C.	X	O	O
N.C.L.B.	X	X	O
Contact Blocks			
Code	Description		
Blank	No contacts on operator		
Standard			
A	1 N.O. - 1 N.C.		
A1	1 N.O. - 1 N.C.L.B.		
A7	1 N.C. - 1 N.C.L.B.		
PenTUFF (Low Voltage)			
AV	1 N.O. - 1 N.C.		
Class 1, Div. 2/Zone 2			
Logic Reed			
AR	1 N.O. - 1 N.C.		
Sealed Switch			
AP	1 N.O. - 1 N.C.		
Stackable Sealed Switch			
AY	1 N.O. - 1 N.C.		

§ See page 10-20 (Table f) for additional voltage code options.

‡ Devices with N.C.L.B. contacts meet EN ISO 13850 and EN/IEC 60947-5-5 standards for emergency stop applications.

‡ Diode type dual input provides circuit isolation via opposing diodes. Not recommended for use with solid-state outputs.

▲ Dual input diode only.

Potentiometer Devices\*❄



Cat. No. 800T-U24



Cat. No. 800H-UR4

Resistance	Type 4/13	Type 4/4X/13	Resistance	Type 4/13	Type 4/4X/13
	Potentiometer‡	Potentiometer‡		Potentiometer‡	Potentiometer‡
	Cat. No.	Cat. No.		Cat. No.	Cat. No.
Operator Only without Resistive Element	<b>800T-N37§</b>	<b>800H-N102§</b>	25 kΩ	<b>800T-U37</b>	800H-UR37
150 Ω	<b>800T-U4</b>	<b>800H-UR4</b>	50 kΩ	<b>800T-U41</b>	<b>800H-UR41</b>
500 Ω	<b>800T-U12</b>	<b>800H-UR12</b>	75 kΩ	800T-U46	800H-UR46
1000 Ω	<b>800T-U13</b>	<b>800H-UR13</b>	100 kΩ	<b>800T-U49</b>	<b>800H-UR49</b>
1500 Ω	<b>800T-U16</b>	<b>800H-UR16</b>	150 kΩ	<b>800T-U50</b>	800H-UR50
2500 Ω	<b>800T-U19</b>	<b>800H-UR19</b>	400 kΩ	800T-U54	800H-UR54
5000 Ω	<b>800T-U24</b>	<b>800H-UR24</b>	500 kΩ	<b>800T-U55</b>	800H-UR55
10 kΩ	<b>800T-U29</b>	<b>800H-UR29</b>	1 MΩ	<b>800T-U57</b>	<b>800H-UR57</b>
15 kΩ	<b>800T-U34</b>	800H-UR34	2 MΩ	800T-U59	800H-UR59
20 kΩ	<b>800T-U35</b>	<b>800H-UR35</b>	3 MΩ	800T-U62	800H-UR62
			4 MΩ	800T-U64	800H-UR64

\* Single turn operation with 312° rotation.

❄ Does not meet Class 1 Div. 2 applications.

‡ Rated for 300V AC/DC, 2 W maximum (6V DC minimum). Specify Bulletin 800TC or 800HC for finger-safe potentiometers. Example: **Cat. No. 800T-U29** becomes **Cat. No. 800TC-U29**.

§ For use with Type J potentiometers having a shaft length of 7/8 in. (22.2 mm) and a shaft diameter of 1/4 in. (6.3 mm).

Mechanically Interlocked Maintained Push Button Devices



Cat. No. 800T-FA22A



Cat. No. 800T-FB16A



Cat. No. 800T-FC16F



Cat. No. 800H-CRA22A

Contact Arrangement		Type 4/13			Type 4/4X/13	
		Button Position: Button Type/Color➤			Bootless♣	
Contact Type	Configuration/ Position	Upper: Flush/Black Lower: Flush/Black	Upper: Flush/Green Lower: Extended/ Red	Upper: Flush/Green Lower: Mushroom/ Red	Upper: Flush/Green Lower: Extended/ Red	Upper: Flush/Black Lower: Flush/Black
		Cat. No.	Cat. No.	Cat. No.	Cat. No.	Cat. No.
1 N.O. - 1 N.C.		<b>800T-FA22A</b>	<b>800T-FB16A</b>	<b>800T-FC16A</b>	800H-CRB16A	800H-CRA22A
2 N.O. - 2 N.C.		800T-FA22F	<b>800T-FB16F</b>	<b>800T-FC16F</b>	800H-CRB16F	800H-CRA22F
No Contact	—	800T-FA22	800T-FB16	800T-FC16	800H-CRB16	800H-CRA22

➤ Consult your local Rockwell Automation sales office or Allen-Bradley distributor for other operator types and combinations.

♣ If booted operators are desired, refer to page 10-39 to order boots separately.

Bulletin 800T/H  
**30.5 mm Push Buttons**  
 Specialty Operators

Cluster Pilot Light Devices (Bul. 800T Only)\*



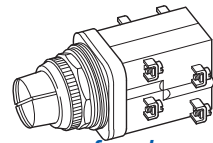
Color Cap Only With Lamps  
 Cat. No. 800T-N249



Complete Unit  
 Cat. No. 800T-PC416

Type	Lamp Type	Volts	Type 4/13	
			Color Cap With Lamps Cat. No.	Complete Unit Cat. No.
<b>2-Light Color Cap with Lamps</b> 2 Light 	Incandescent	24V AC/DC Full Voltage	800T-N257	<b>800T-QC224</b>
	LED	24V AC/DC Full Voltage	800T-N257L	<b>800T-QCL224</b>
	Incandescent	120V AC, 50/60 Hz Transformer	<b>800T-N52</b>	<b>800T-PC216</b>
<b>3-Light Color Cap with Lamps</b> 3 Light 	Incandescent	24V AC/DC Full Voltage	800T-N254	<b>800T-QC324</b>
	LED	24V AC/DC Full Voltage	800T-N254L	800T-QCL324
	Incandescent	120V AC, 50/60 Hz Transformer	<b>800T-N51</b>	<b>800T-PC316</b>
<b>4-Light Color Cap with Lamps</b> 4 Light 	Incandescent	24V AC/DC Full Voltage	800T-N251	<b>800T-QC424</b>
		120V AC, 50/60 Hz Transformer	<b>800T-N50</b>	<b>800T-PC416</b>

800T - PC 3 16 W R X R  
 a b c d e f g h  
 Position 1 Position 2 Position 3 Position 4



**a**

Finger-Safe Guards	
Code	Description
Blank	No guards
C	Guards on terminals

**b**

Power Module Type	
Code	Description
QC	Full voltage
PC	Transformer

**c**

Illumination Options and No. of Units	
Incandescent	
Code	Description
2	2 unit cluster
3	3 unit cluster
4	4 unit cluster
LED*†‡§	
L2	2 unit cluster
L3	3 unit cluster
L4	4 unit cluster

**d**

Voltage Options	
Full Voltage	
Code	Description
06	6V AC/DC
12	12V AC/DC
24	24V AC/DC
Transformer	
16	120V AC, 50/60 Hz

**e, f, g, h**

Color Options	
Code	Color
Blank (All 4 Positions)	Standard unit ▶
X	No color
A	Amber
B	Blue
C	Clear
G	Green
R	Red
W	White

Custom Lens Caps for Cluster Pilot Lights

800T - N249 R G A W  
 a b c d e f  
 Position 1 Position 2 Position 3 Position 4



**a**

No. of Lamps/Voltage	
Transformer	
Code	Description
N50	4 lamps, 120V AC, 50/60 Hz
N51	3 lamps, 120V AC, 50/60 Hz
N52	2 lamps, 120V AC, 50/60 Hz
N249	4 lamps, 6V AC/DC
N250	4 lamps, 12V AC/DC
N251	4 lamps, 24V AC/DC
N252	3 lamps, 6V AC/DC
N253	3 lamps, 12V AC/DC
N254	3 lamps, 24V AC/DC
N255	2 lamps, 6V AC/DC
N256	2 lamps, 12V AC/DC
N257	2 lamps, 24V AC/DC

**b**

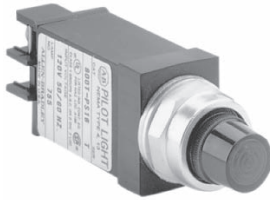
Illumination Options	
Code	Description
Blank	Incandescent
L	LED*

**c, d, e, f**

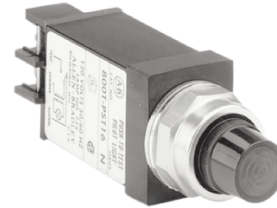
Code	Description
Blank (All Positions)	Standard unit ▶
A	Amber
B	Blue
C	Clear
G	Green
R	Red
W	White
X	No color

- \* Rated Type 4/13 indoor only.
- ‡ LEDs are available in red, green and amber only; lens color matches LED color. Exception: the white lens is supplied with an amber LED.
- † White lenses use amber LEDs.
- § LEDs could be adversely affected when used with solid-state outputs.
- ‡ 6V and 12V are positive polarity. 24V LEDs are bipolar.
- ▶ See table above for standard unit colors.

18 mm Small Pilot Lights Type 4/13, Class I, Division 2



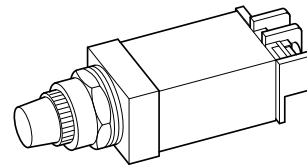
18 mm Pilot Light  
 Cat. No. 800T-PS16R



18 mm Push-to-Test Pilot Light  
 Cat. No. 800T-PST16R

Type	Lamp	Voltage	Color	Pilot Light	Push-To-Test
				Cat. No.	Cat. No.
Transformer	Incandescent	120V AC 50/60 Hz	Red	<b>800T-PS16R</b>	<b>800T-PST16R</b>
	LED			800T-PSH16R	800T-PSTH16R
Dual Input Diode	Incandescent	120V AC		<b>800T-PSD16R</b>	—
		24V AC/DC		800T-PSD24R	—
Dual Input Transformer	Incandescent	120V AC/DC 50/60 Hz		800T-PSDT16R	—
		24V AC/DC		<b>800T-QS24R</b>	<b>800T-QST24R</b>
Full Voltage	LED	24V AC/DC		<b>800T-QSH24R</b>	800T-QSTH24R
		120V AC		<b>800T-QSH10R</b>	800T-QSTH10R
	Neon	120V AC/DC		<b>800T-RS10A</b>	800T-RST10A

800T – PS      D      c      16      R  
                   a      b      c      d      e



**a**

Power Module Type	
Code	Description
PS	Transformer (or dual input)
QS	Full voltage
RS	Neon*

**b**

Lamp Test Options	
Code	Description
Blank	No test option
D	Dual input diode
DT	Dual input transformer relay ▶
T	Push-to-test ▶

- \* Neon is only available in amber or clear.
- ‡ LEDs available in red, green, amber, blue, and white. LED color matches lens color, except clear lens supplied with white LED and white lens supplied with amber LED. All LEDs except 120V have an internal shunt resistor for use with solid-state outputs.
- ♣ Dual input diode only.
- ▶ Class 1, Division 2 rating not available. Push-to-test rated for Type 13 only.

**c**

Illumination Options	
Transformer/Full Voltage/Dual Input	
Code	Description
Blank	Incandescent
H	LED‡
Neon	
Blank	No options

**d**

Voltage	
Transformer	
Code	Description
16	120V AC 50/60 Hz
26	240V AC 50/60 Hz
Full Voltage Incandescent	
12	12V AC/DC
24	24V AC/DC
Full Voltage LED	
10	120V AC
13	130V AC/DC
24	24V AC/DC
Neon	
10	120V AC/DC
20	240V AC/DC
Dual Input	
16	120V AC 50/60 Hz
24	24V AC/DC♣

**e**

Lens Color	
Plastic	
Code	Description
Blank	No lens
A	Amber
B	Blue
C	Clear
G	Green
R	Red
W	White









Cylinder Lock Push Button Devices (Bul. 800T only)



Cylinder Lock Push Button  
 Cat. No. 800T-E15A



Mushroom Style Cylinder Lock  
 Cat. No. 800T-E15M6A

Type of Cylinder Lock	Lock Position	Type 4/13	
		Standard Cylinder Lock	Red Mushroom Cylinder Lock
		Cat. No.*	Cat. No.*❖
<b>Spring Bolt</b> — Lock can be set with key when button is in the OUT position. Button will lock when depressed. Key removable in any position. 1 N.O. - 1 N.C.	IN	<b>800T-E15A</b>	<b>800T-E15M6A</b>
<b>Dead Bolt A</b> — Button can only be operated with the key in the lock. Key removable in locked position only. 1 N.O. - 1 N.C.	IN	<b>800T-E24A</b>	<b>800T-E24M6A</b>
	OUT	<b>800T-E14A</b>	800T-E14M6A
<b>Dead Bolt B</b> — Button can be operated with or without the key inserted in the lock. Key removable in any position. 1 N.O. - 1 N.C.	IN	800T-E12A	<b>800T-E12M6A</b>
	OUT	<b>800T-E11A</b>	800T-E11M6A

\* Each device supplied with 2 keys. Replacement key part no. for standard E158 is X-144218.

❖ For jumbo size mushroom cap, change **M** to **J**. Example: Cat. No. 800T-E15M6A becomes Cat. No. 800T-E15J6A.

Momentary Padlocking Mushroom Head Devices (Bul. 800T only) ‡



Padlocking Mushroom Button  
 Cat. No. 800T-D6QA



Padlocking Jumbo Mushroom Button  
 Cat. No. 800T-D6LQA

Contact Type	Button Color	Type 4/13	
		Standard Size Metal Mushroom Head	Jumbo Size Metal Mushroom Head
		Cat. No.§	Cat. No.§
No Contact	Red	<b>800T-D6Q</b>	800T-D6LQ
1 N.O.		800T-D6QD1	800T-D6LQD1
1 N.C.		<b>800T-D6QD2</b>	800T-D6LQD2
1 N.O. - 1 N.C.		<b>800T-D6QA</b>	800T-D6LQA

‡ Allows locking in the depressed position. Will hold N.C. contacts open, but might not hold N.O. contacts closed.

§ To order without the padlocking attachment, change **Q** to **F**. Example: Cat. No. 800T-D6QA becomes Cat. No. 800T-D6FA

Momentary Wobble Stick Push Button Devices (Bul. 800T Type 13 only)



Wobble Stick Unit  
 Cat. No. 800T-M1B





Contact Type	Wobble Stick♣
No Contacts	Cat. No. 800T-M1
1 N.O.	800T-M1D1
1 N.O. - 1 N.C.	<b>800T-M1A</b>
2 N.O. - 2 N.C.	800T-M1B

♣ Can be operated from any angle.










Bulletin 800T/H  
**30.5 mm Push Buttons**  
 Specialty Operators

**Break-Glass Push Button Stations (Bul. 800T only)**  
 Complete Station

	Description	Contact Type	Cat. No.
 <i>Cat. No. 800T-NX114</i>	<b>Break-Glass Push Button Station</b> Red push button station in a Type 4/13 enclosure incorporates either one or two snap-action contact blocks, which are operated when the small glass window is broken. Includes STOP legend.	 1 N.O. - 1 N.C.	<b>800T-NX114</b>
		  2 N.O. - 2 N.C.	<b>800T-NX115</b>

**Miscellaneous Kits**

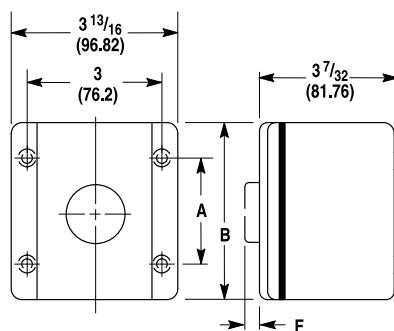
	Description	Contact Type	Cat. No.
 <i>Cat. No. 800T-S6M</i>	<b>Unit Only Kit</b> The break-glass unit less the enclosure is available as a kit to install into the customer's enclosure. The kit includes the contact unit, the hammer and chain and five extra glass discs with one button tack. This kit does not include legend plate. For legend plates, see page 10-48.	 1 N.O. - 1 N.C.	<b>800T-S6M</b>
		 2 N.O. - 2 N.C.	<b>800T-S6N</b>
 <i>Cat. No. 800T-NXM</i>	<b>Replacement Snap Action Contact Block Kit</b> This kit is used to replace the snap action contact block.	 1 N.O. - 1 N.C.	<b>800T-NXM</b>
		 2 N.O. - 2 N.C.	<b>800T-NXN</b>
 <i>Cat. No. 800T-N28</i>	<b>Glass Disc Kit</b> Each replacement kit for break-glass push button units or stations consists of six glass discs and one button tack.	Description	
		Cat. No.	
			<b>800T-N28</b>

**10**

**Approximate Dimensions**

Dimensions in inches (millimeters). Dimensions are not intended to be used for manufacturing purposes.

**Break-Glass Station**



A = 2 3/4 (69.85)  
 B = 4 3/16 (106.38)  
 F = 9/16 (14.28)



Custom-Built Stations



**Description**

The table on page 10-5 lists the most commonly used Bulletin 800T/800H push button stations. Stations not listed in this table may be ordered as custom-built stations.

**Cat. No.**






The cat. no. used to identify custom-built Bulletin 800T push button stations will be cat. no. listed for enclosure only. The letter **Z** will be substituted for the letter **W** and a station serial no. will be added.

**Ordering Information**

The following information is required when ordering custom-built push button stations.

1. Cat. no. of enclosure.
2. Cat. no. of control units.
3. Legend plate cat. no. and/or marking for each unit.
4. Specify vertical/horizontal mounting.
5. Specify desired operator mounting sequence. Inclusion of a sketch is recommended. If no information is given, standard configuration will be used.

Enclosures

No. of Operator Openings	Surface Mount*		Flush Mount	Pendant Type	
	Die Cast* (Type 4/13)	Sheet Metal (Type 13)	Die Cast Face Plate (Type 4/13)	One Hole in Bottom (Type 13)	Openings in Cover (Type 13)
	 <i>Cat. No. 800T-2TZ</i>	 <i>Cat. No. 800T-6TJZ</i>	 <i>Cat. No. 800T-2ZT</i>	 <i>Cat. No. 800T-2PZ</i>	 <i>Cat. No. 800T-2PY</i>
	Cat. No.	Cat. No.	Cat. No.	Cat. No.	Cat. No.
1	<b>800T-1TZ</b> *	—	<b>800T-1ZT</b>	—	—
2	<b>800T-2TZ</b> *	—	800T-2ZT	800T-2PZ	<b>800T-2PY</b>
3	<b>800T-3TZ</b> *	—	800T-3ZT	800T-3PZ	800T-3PY
4	<b>800T-4TZ</b> *	—	800T-4ZT	800T-4PZ	800T-4PY
5	—	—	—	800T-5PZ	800T-5PY
6‡	<b>800T-6TZ</b> *	—	800T-6ZT	800T-6PZ	800T-6PY
6§	<b>800T-6THZ</b> *	<b>800T-6TJZ</b>	800T-6ZTH	—	—
7	—	—	—	800T-7PZ	800T-7PY
8	—	—	—	800T-8PZ	800T-8PY
9	<b>800T-9TZ</b>	800T-9TJZ	800T-9ZT	800T-9PZ	800T-9PY
10	—	—	—	800T-10PZ	800T-10PY
12	<b>800T-12TZ</b>	800T-12TJZ	800T-12ZT	—	—
16	800T-16TZ	800T-16TJZ	800T-16ZT	—	—
20	—	800T-20TJZ	—	—	—
25	—	800T-25TJZ	—	—	—

**Note:** Specialty enclosures available. Please refer to KB Q69259778.

**Note:** Enclosure and conduit dimensions are detailed on page 10-61.

\* Bottom conduit entry. Grounding provision provided.

\* Enclosure depth will accommodate one shallow and one mini-contact block stacked.

\* Add suffix **Y** to the cat. no. for yellow painted enclosure. Example: **Cat. No. 800T-1TZY**.

‡ One vertical row.

§ Two vertical rows of three holes.

# 30.5 mm Push Buttons

## Custom-Built Stations/Enclosures

### Custom-Built Stations (800H only)



#### Cat. No.

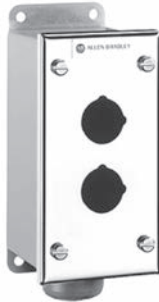
The cat. no. used to identify custom-built Bulletin 800H push button stations will be cat. no. listed for enclosure only. The letter **W** is substituted for the letter **Z** and a station serial no. will be added.

#### Ordering Information

The following information is required when ordering custom-built push button stations:

1. Cat. no. of enclosure.
2. Cat. no. of control units.
3. Legend plate cat. no. and/or marking for each unit.
4. Specify vertical/horizontal mounting.
5. Specify operator mounting sequence that you want. Including a sketch is recommended. If information not given, standard configuration will be used.

### Enclosures (800H only)



*Stainless Steel*  
Cat. No. 800H-2HZ4



*Rosite Glass Polyester*  
Cat. No. 800H-2HZ4R



*Fiberglass*  
Cat. No. 800H-2HZ4Y



*Thermoplastic Polyester*  
Cat. No. 800H-2HZ4C

No. of Operator Openings	Conduit Hubs		Stainless Steel (#304) Type 4/4X/13*	Rosite Glass Polyester Type 4/4X/13	No. of Operator Openings	Conduit Openings		Fiberglass* Type 4/4X/13	Thermoplastic Polyester* Type 4/4X
	No.	Dia. [in.]	Cat. No.	Cat. No.		No.	Dia. [in.]‡	Cat. No.	Cat. No.
0§	1	3/4	800H-0HZ4	—	1	1	3/4	800H-1HZ4Y	800H-1HZ4C
1	1	3/4	800H-1HZ4	800H-1HZ4R	2	1	1	800H-2HZ4Y	800H-2HZ4C
1	2	3/4	—	800H-1HZ4RM1	3	1	1	800H-3HZ4Y	800H-3HZ4C
1	1	1	—	800H-1HZ4RM2	4	—	—	—	800H-4HZ4C
2	1	3/4	800H-2HZ4	800H-2HZ4R	—	—	—	—	—
2	2	3/4	800H-2HZ4M1	800H-2HZ4RM1	—	—	—	—	—
2	1	1	800H-2HZ4M2	800H-2HZ4RM2	—	—	—	—	—
3	1	3/4	800H-3HZ4	800H-3HZ4R	—	—	—	—	—
3	2	3/4	800H-3HZ4M1	800H-3HZ4RM1	—	—	—	—	—
4	1	3/4	800H-4HZ4	800H-4HZ4R	—	—	—	—	—
4	2	3/4	800H-4HZ4M1	800H-4HZ4RM1	—	—	—	—	—
5	1	1	800H-5HZ4	—	—	—	—	—	—
6	1	1	800H-6HZ4	800H-6HZ4R	—	—	—	—	—
7	1	1	800H-7HZ4	—	—	—	—	—	—
8	1	1	800H-8HZ4	—	—	—	—	—	—

**Note:** Other combinations of conduit hub sizes are available upon request. Enclosure and conduit dimensions are detailed on page 10-61.

\* Grounding screw provided with stainless steel enclosure.

⊗ Extra deep. Accommodates two levels of stackable sealed switch contact blocks.

‡ Conduit hubs must be ordered separately. For 3/4 in. hub, order **Cat. No. 1490-N9**. For 1 in. hub, order **Cat. No. 1490-N10**.

§ Identical to **Cat. No. 800H-1HZ4** but without mounting holes.

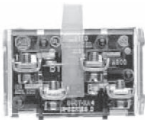
♣ No conduit openings provided.

➤ Yellow thermoplastic enclosures may be ordered by adding a **Y** to the cat. no. Example: **Cat. No. 800H-1HZ4C** becomes **Cat. No. 800H-1HZ4CY**.

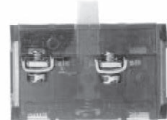
**Contact Blocks**

Packaged in kit form for field installation. All necessary mounting hardware is provided with each contact block kit. **Contact ratings are listed on page 10-4.**

**Note:** It is not recommended to mount more than four contact blocks on any one non-illuminated operator (maximum two blocks deep). Contact blocks cannot be stacked onto power modules, so illuminated operators are limited to two contact blocks. Sealed switch contact blocks are not stackable and are limited to two blocks per operator. Time delay contacts are only available as one circuit per operator.



**Shallow Block**



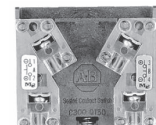
**PenTUFF™ (Low Voltage) Contact Block**



**Logic Reed Block**



**Sealed Switch Block**



**Stackable Sealed Switch Block**

Contact Type	Shallow Block**		PenTUFF (Low Voltage) Block**		Logic Reed Block‡		Sealed Switch Block‡		Stackable Sealed Switch Block‡	
	Cat. No.	Code	Cat. No.	Code	Cat. No.	Code	Cat. No.	Code	Cat. No.	Code
1 N.O.	800T-XD1	D	800T-XD1V	H	800T-XD1R	V	800T-XD1P	R	800T-XD1Y	5
1 N.C.	800T-XD2	E	800T-XD2V	U	800T-XD2R	W	800T-XD2P	S	800T-XD2Y	6
1 N.O.E.M.	800T-XD3	G	800T-XD3V	I	—	—	—	—	—	—
1 N.C.L.B.	800T-XD4	J	800T-XD4V	Q	—	—	—	—	—	—
1 N.O. - N.C.	800T-XA	A	800T-XAV	F	800T-XAR	T	800T-XAP	P	800T-XAY	7
2 N.O.	800T-XA2§	M	—	—	800T-XA2R§	Y	—	—	800T-XA2Y	8
2 N.C.	800T-XA4	N	—	—	800T-XA4R	Z	—	—	800T-XA4Y	9
1 N.C.L.B. - 1 N.O.	800T-XA1	B	—	—	—	—	—	—	—	—
1 N.C.L.B. - 1 N.C.	800T-XA7	C	—	—	—	—	—	—	—	—

**Note:** Modular suffix codes can be used when specifying selector switches with multiple contact blocks.



**Self Monitoring Contact Block**



**Mini Block**



**Time Delay Block**



**MaxDuty Block**

Contact Type	S.M.C.B.*->	
	Cat. No.	Code
1 N.C.L.B. (wired in series with 1 N.O. monitoring contact)	800TC-XD4S	3

Contact Type	Mini Block*		Time Delay Block*	MaxDuty Block	
	Cat. No.	Code	Cat. No.	Cat. No.	Code
1 N.O.	800T-XD5	K	800T-XT	800T-XD1M	1
1 N.C.	800T-XD6	L	800T-XS	800T-XD2M	2
1 N.C.L.B.	—	—	—	800T-XD4M	4

**Note:** Modular suffix codes can be used when specifying selector switches with multiple contact blocks.

\* Contact blocks with normally closed contacts meet direct drive positive opening standard requirements when properly fused to IEC 269-1 and 269-2. Shallow/mini contacts: 10 A gl or N type cartridge fuse. PenTUFF contacts: 6 A gl or N type cartridge fuse.

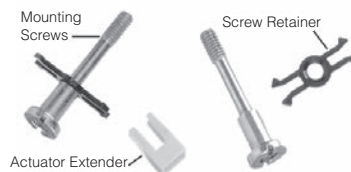
\*\* Specify Bulletin 800TC for finger-safe contact blocks. Example: **Cat. No. 800T-XA** becomes **Cat. No. 800TC-XA**.

‡ 800T operator using sealed switch and logic reed contact blocks and installed in a suitable enclosure are UL Listed as suitable for use in Class I, Division 2/Zone 2 hazardous locations.

§ Additional contacts cannot be stacked on XA2 and XA2R contact blocks.

♣ For contact ratings, see page 10-4.

> For use with 2-position push-pull or push-pull/twist operators only. Must be mounted on the first level of the operator. The N.O. monitoring contact automatically closes when the S.M.C.B. is properly installed onto the operator. If the S.M.C.B. is separated from the operator, the N.O. monitoring contact automatically opens.



**Shallow Contact Block Hardware**

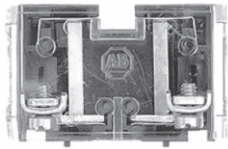
Description	Cat. No.
Contact Block Mounting Screw	800T-N335
Screw Retainer	800T-N336
Actuator Extender	800T-N337



Bulletin 800T/H  
**30.5 mm Push Buttons**  
 Accessories

**Power Modules**

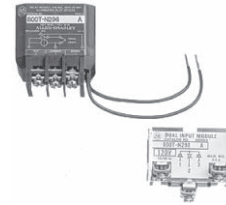
Packaged in kit form for field installation. Lamps are listed on page 10-45.



Full Voltage Power Module  
 Cat. No. 800T-N330



Transformer Power Module  
 Cat. No. 800T-N326



Dual Input Power Modules  
 Cat. No. 800T-N296 (Transformer)  
 Cat. No. 800T-N290N (Diode)

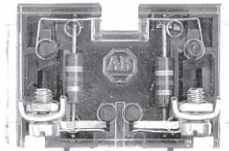
Full Voltage§		Transformer§		Dual Input		
Lamp Voltage	Cat. No.	Voltage	Cat. No.	Type	Voltage	Cat. No.
6...130V AC/DC	800T-N330	48V AC 50/60 Hz	800T-N325	Transformer*	120V AC	800T-N296
		120V AC 50/60 Hz	<b>800T-N326</b>	Diode Type*	24V AC/DC	800T-N291N
		240V AC 50/60 Hz	<b>800T-N327</b>		120V AC/DC	800T-N290N
		277V AC 50/60 Hz	800T-N327Y		—	—
		480V AC 50/60 Hz	<b>800T-N328</b>	—	—	
240V AC/DC‡	800T-N331	600V AC 50/60 Hz	800T-N329	—	—	—

\* Transformer type dual input provides circuit isolation via a miniature type relay. This module is used in conjunction with a 120V transformer.

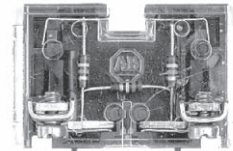
\* Diode type dual input provides circuit isolation via opposing diodes. Not recommended for use with solid-state outputs and neon indicators.

‡ 240V full voltage module contains 50% dropping resistors for use with a 120V incandescent lamp.

§ Specify Bulletin 800TC for finger-safe power modules. Example: **Cat. No. 800T-N330** becomes **Cat. No. 800TC-N330**.



Resistor Power Module  
 Cat. No. 800T-N332



Neon Power Module  
 Cat. No. 800T-N333

Resistor (10% Drop)➤		Neon♣➤	
Voltage	Cat. No.	Voltage	Cat. No.
120V AC/DC	800T-N332	120V AC/DC	800T-N333
		240V AC/DC	800T-N334

♣ Neon modules contain resistors.

➤ Specify Bulletin 800TC for finger-safe power modules. Example: **Cat. No. 800T-N332** becomes **Cat. No. 800TC-N332**.

**Universal LED Module**



Voltage	Cat. No.
12...130V AC/DC	800TC-N374

10

**Trigger Action E-Stop Latches**



Cat. No. 800T-N380



Cat. No. 800T-N379

Description	Cat. No.
Illuminated type	800T-N380
Non-illuminated type	800T-N379



**Replacement Color Caps**

Color caps listed below are for field replacement on installed devices or for completion of devices ordered with color caps omitted.



*Push-Pull*



*Push-Pull/Twist*



*Push-Pull Jumbo*



*Push-Pull/Twist Jumbo*

**Push-Pull Color Caps, Illuminated**

Color	800T Push-Pull	800H Push-Pull	800T/H Push-Pull/Twist	800T/H Push-Pull Jumbo	800T/H Push-Pull/Twist Jumbo
	Cat. No.	Cat. No.	Cat. No.	Cat. No.	Cat. No.
Amber	<b>800T-N159A</b>	800H-N112A	800T-N301A	800T-N209A	800T-N306A
Blue	<b>800T-N159B</b>	800H-N112B	800T-N301B	800T-N209B	800T-N306B
Clear	<b>800T-N159C</b>	800H-N112C	800T-N301C	800T-N209C	800T-N306C
Green	<b>800T-N159G</b>	<b>800H-N112G</b>	800T-N301G	800T-N209G	800T-N306G
Red	<b>800T-N159R</b>	<b>800H-N112R</b>	<b>800T-N301R</b>	<b>800T-N209R</b>	800T-N306R
White	<b>800T-N159W</b>	800H-N112W	800T-N301W	800T-N209W	800T-N306W



*Illuminated Mushroom*



*Illuminated Jumbo Mushroom*



*Standard*



*Push-to-Test*



*Glass Caps for Pilot Lights*

Color	800T/H Push Button Color Caps, Illuminated		800T/H Pilot Light Color Caps			Glass Caps for 800T Pilot Lights
	Mushroom	Jumbo Mushroom	Standard*	Push-to-Test*	18 mm	
	Cat. No.	Cat. No.	Cat. No.	Cat. No.	Cat. No.	
Amber	<b>800T-N304A</b>	800T-N305A	<b>800T-N26A</b>	<b>800T-N42</b>	<b>800T-N122A</b>	800T-N22
Blue	800T-N304B	800T-N305B	<b>800T-N26B</b>	<b>800T-N43</b>	<b>800T-N122B</b>	800T-N23
Clear	800T-N304C	800T-N305C	<b>800T-N26C</b>	<b>800T-N45</b>	800T-N122C	800T-N25
Green	<b>800T-N304G</b>	800T-N305G	<b>800T-N26G</b>	<b>800T-N41</b>	<b>800T-N122G</b>	800T-N21
Red	<b>800T-N304R</b>	<b>800T-N305R</b>	<b>800T-N26R</b>	<b>800T-N40</b>	<b>800T-N122R</b>	800T-N20
White	800T-N304W	800T-N305W	<b>800T-N26W</b>	<b>800T-N44</b>	<b>800T-N122W</b>	800T-N24

\* Available in bulk quantities of 20. Add suffix (-BP) to the cat. no. and order in multiples of 20.



*Plastic Mushroom*



*Plastic Jumbo Mushroom*



*Padlocking Metal Mushroom*



*Metal Jumbo Mushroom*

**Push Button Color Caps, Non-Illuminated**

Button Color	800T Plastic Mushroom	800H Plastic Mushroom	800T Plastic Jumbo Mushroom	800H Plastic Jumbo Mushroom	800T Padlocking Metal Mushroom	800T Metal Jumbo Mushroom	
	Cat. No.	Cat. No.	Cat. No.	Cat. No.	Cat. No.		Cat. No.
Red	<b>800T-N246R</b>	<b>800H-N114A</b>	<b>800T-N247R</b>	800H-N115A	<b>800T-N311R</b>	*	<b>800T-N248R</b>
Green	<b>800T-N246G</b>	800H-N114B	<b>800T-N247G</b>	800H-N115B	800T-N311G	*	800T-N248G
Black	<b>800T-N246B</b>	800H-N114H	<b>800T-N247B</b>	800H-N115H	800T-N311B	*	800T-N248B
Orange	800T-N246O	800H-N114F	800T-N247O	800H-N115F	800T-N311O	⊛	800T-N248O
Grey	800T-N246GR	800H-N114G	800T-N247GR	800H-N115G	800T-N311GR		800T-N248GR
Blue	800T-N246BL	800H-N114C	800T-N247BL	800H-N115C	800T-N311BL	*	800T-N248BL
Yellow	<b>800T-N246Y</b>	800H-N114E	800T-N247Y	800H-N115E	800T-N311Y	*	800T-N248Y
Natural	—	—	—	—	—	‡	800T-N248
White	800T-N246W	800H-N114L	—	800H-N115L	—		—

For padlocking jumbo mushroom style:

\* change listed cat. no. from **248** to **313**. Example: **Cat. No. 800T-N248G** becomes **Cat. No. 800T-N313G**.

⊛ change listed cat. no. from **Cat. No. 800T-N248O** to **Cat. No. 800T-N313**.

‡ change listed cat. no. from **Cat. No. 800T-N248** to **Cat. No. 800T-N313GR**.



**Booted Selector Switch Knobs, Non-Illuminated (800H only)**



**Cat. No. 800H-NR5**

Insert Material	Material			
	Chlorosulfonated Polyethylene ‡	Silicone • ‡	Urethane •• ‡	Ethylene • Propylene •• ‡
	Cat. No.	Cat. No.	Cat. No.	Cat. No.
Brass *	<b>800H-NR5</b>	800H-NR101	800H-NR100	800H-NR103
Stainless Steel	800HS-NR5	800HS-NR101	800HS-NR100	800HS-NR103

\* Color insert packet (Cat. No. 800T-N123) is included in each kit.  
 ‡ Dots printed on the inside of the boot identify the boot material.

**Protective Boots**

**Protective Boot for Illuminated Push Buttons**



**Cat. No. 800H-N11**



**Cat. No. 800H-N12**

Description	Type	Cat. No.
May be added to guarded units, units without guard or Push-to-Test devices. This protective boot guards against the entrance of foreign materials reaching the opening between the button and locking ring.	Boot without Guard	<b>800H-N11</b>
	Boot with Guard	<b>800H-N12</b>

**Protective Boots for Non-Illuminated Push Buttons\***

Boots supplied with control stations and components are made of a chlorosulfonated polyethylene material with stainless steel insert ring. To order boots with silicone, urethane, or ethylene propylene material, see the table below. Material application information shown below.



**Cat. No. 800H-N5A**

Insert Material	Boot Color	Material			
		Chlorosulfonated Polyethylene ‡	Silicone • ‡	Urethane •• ‡	Ethylene • Propylene •• ‡
		Cat. No.	Cat. No.	Cat. No.	Cat. No.
Stainless steel §	Red	<b>800H-N5A</b>	<b>800H-N101R</b>	<b>800H-N100R</b>	800H-N103R
	Green	<b>800H-N5B</b>	<b>800H-N101G</b>	<b>800H-N100G</b>	800H-N103G
	Black	<b>800H-N5H</b>	<b>800H-N101B</b>	<b>800H-N100B</b>	800H-N103B
	Yellow	<b>800H-N5E</b>	<b>800H-N101Y</b>	800H-N100Y	—
	Blue	<b>800H-N5C</b>	800H-N101BL	800H-N100BL	—

\* May be added to flush or extended head push button units to protect against foreign materials reaching the opening between the button and the locking ring.  
 § Series B boots incorporate a stainless steel insert as standard.  
 ‡ Dots printed on the inside of the boot identify the boot material.

**Protective Boot Application Information**

– **Chlorosulfonated Polyethylene (synthetic rubber)**

Very resistant to attack by oxidizing chemicals such as concentrated sulfuric acid and hypochlorite solutions. Also resistant to attack by oils and performs well in a wide range of other chemicals and solvents. Good flex and high impact resistance. This is the standard boot material supplied with 800H NEMA Type 4/4X push buttons unless otherwise specified.

– **Silicone**

Superior high temperature resistance. Particularly suited for use where organic acids or vegetable oils may be present. Also superior resistance to the effects of outdoor use, such as oxygen, ozone, and weather.

– **Urethane**

Excellent resistance to mechanical failure. Most durable boot material. Particularly suited for use where lubricating oils and automotive fuels may be present. Also well-suited for outdoor use.



– **Ethylene-propylene**

Particularly suited for high temperature applications. Resistant to attack by many acids and alkalis, detergents, phosphate esters, ketones, alcohols, and glycols. Outstanding service in areas with hot water and steam wash downs.





Potentiometer Replacement Knobs

Description	Cat. No.
Type 4/13 (800T)	40274-073-55
Type 4/4X/13 (800H)	40274-073-54

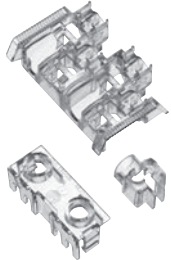




Push Buttons

	Description	Cat. No.
 Cat. No. 800T-N179 <i>(Operators not included)</i>	<b>Bul. 800T/H Mechanical Interlock</b> Used on momentary contact push button units. Guards against closing the N.O. contacts of one button while the other button's N.O. contacts are closed. Buttons remain momentary. For maintained units, see page 10-25.	800T-N179
 Cat. No. 800T-N12	<b>Bul. 800T Rocker Arm Operating Lever</b> The rocker arm lever operates two flush head or one flush with one extended head momentary contact push button units spaced 1-27/32 in. (46.8 mm) center-to-center. Legend plates must be ordered separately and should be inverted 180° prior to engraving and installation.	800T-N12

Miscellaneous






	Description	Cat. No.
 Cat. No. 800T-N245	<b>Bul. 800T/H Mounting Ring Wrench</b> This wrench will simplify tightening or loosening the octagonal mounting ring used on Bul. 800T units. This wrench is double-ended and can be used for 18 mm and 30 mm pilot light mounting rings.	800T-N245
 Cat. No. 800T-N209RE1	<b>Bul. 800T/H Jumbo Push-Pull Cap</b> For use on Bul. 800T or 800H push-pull operators. Fits on illuminated and non-illuminated devices.	800T-N209RE1
	<b>Bul. 800T 63 mm Red Anodized Aluminum Cap</b> For use on Bul. 800T non-illuminated push-pull devices.	800T-N210R
	<b>Bul. 800T 63 mm Red Anodized Aluminum Cap with "E-Stop"</b> For use on Bul. 800T non-illuminated push-pull devices.	800T-N210RE
	<b>Bul. 800T 90 mm Gold Anodized Aluminum Cap</b> For use on Bul. 800T non-illuminated push-pull devices.	800T-N211GL
 Cat. No. 800T-N300	<b>Bul. 800T Bonding Bracket</b> The bonding bracket establishes an electrical circuit between the mounting surface and metal operator bushing for grounding purposes; recommended for installations which require CSA approval. Necessary mounting hardware is included. Order Cat. No. 800T-N300 for back-of-panel bracket. Order Cat. No. 800T-N300F for front-of-panel bracket.	800T-N300
		800T-N300F
 Cat. No. 800E-ALR1	<b>Bul. 800T/H Lens/Bulb Removal Tool</b> The small end of this tool provides quick and easy removal of any incandescent or LED lamp.	800F-ALR1

Miscellaneous, Continued

		Description	Cat. No.	
 <b>Cat. No. 800T-N324</b>  <b>Cat. No. 800T-N323</b>  <b>IEC Finger-Safe Accessories</b>	<b>Cat. No. 800T-N323</b>  <b>Cat. No. 800T-N322</b>	<b>Bul. 800T/H IEC Finger-Safe Terminal Guards</b> Snap-on accessories which provide IEC, IP2X and VGB finger-safe protection. Single terminal guards for single circuit contact blocks, full voltage modules, LED modules, etc. (800T-XD1, -XD2, -XD3, -XD4, -XD5, -XD6, -XAP, -XD1P, -XD2P, -PC..., and -QC...)* <b>Note:</b> Must be ordered in multiples of 100 pieces.	<b>800T-N322</b>	
		Transformer covers for transformer only. <b>Note:</b> Must be ordered in multiples of 25 pieces.	<b>800T-N324</b>	
		Multi-terminal side cover for use on single or double circuit contact blocks. (800T-XA, -XA1, -XA2, -XA4, -XA7, -XAR, -XA2R, -XA4R, -XD1R, and -XD2R) <b>Note:</b> Must be ordered in multiples of 25 pieces.	<b>800T-N323</b>	
 <b>Cat. No. 800T-N292</b>		<b>Grey Bul. 800T Trim Washer</b> Used to mount the operator properly when a legend plate is not being used. <b>Note:</b> Must be ordered in multiples of 10 pieces.	<b>800T-N292</b>	
		<b>Plastic Bul. 800H Trim Washer</b> Used to mount the operator properly when a legend plate is not being used. <b>Note:</b> Must be ordered in multiples of 10 pieces.	<b>800H-N148</b>	
 <b>Cat. No. 800T-N293</b>		<b>Metal Bul. 800T Thrust Washer</b> Used to prevent rotation of operators in a keyed or notched hole. <b>Note:</b> Must be ordered in multiples of 10 pieces.	<b>800T-N293</b>	
		<b>Plastic Bul. 800H Thrust Washer</b> Used to prevent rotation of operators in a keyed or notched hole. <b>Note:</b> Must be ordered in multiples of 10 pieces.	<b>800H-N146</b>	
 <b>Cat. No. 800T-N188</b>		<b>Bul. 800T Etching Fluid</b> Used to blacken freshly engraved aluminum legend plates.	<b>800T-N188</b>	
		Description	Color	Cat. No.
 <b>Cat. No. 800T-N1</b>		<b>Bul. 800T/H Closing Button</b> Where an enclosure or flush plate with more than the required number of openings is used, this neat-appearing button can be supplied to close the unused openings.	Grey	<b>800T-N1</b>
			Black	<b>800T-N1B</b>







\* Power modules excluding transformers and dual inputs

**Locking Attachments**

	Description	Cat. No.
 <p><b>Cat. No. 800T-N2</b> (Padlock not included)</p>	<p><b>Bul. 800T</b>  <b>Extended Head Push Button Padlocking Attachments</b>            Permits locking in the depressed position. Locks the normally closed contact in the open position. For extended head non-illuminated momentary push buttons.</p>	<p>800T-N2</p>
 <p><b>Cat. No. 800T-N10</b> (Padlock not included)</p>	<p><b>Bul. 800T</b>  <b>Flush Head Push Button Padlocking Attachments</b>            Permits locking in the depressed position. Locks the normally closed contact in the open position. For flush head push button.</p>	<p>800T-N10</p>
 <p><b>Cat. No. 800T-N315</b> (Padlock not included)</p>	<p><b>Bul. 800T</b>  <b>Momentary Mushroom Padlocking Attachments</b>            For Bul. 800T non-illuminated momentary mushroom push button. Requires use of Cat. No. 800T-N311 mushroom cap. This device is used to lock the mushroom button in a depressed position.</p>	<p>800T-N315</p>
 <p><b>Cat. No. 800T-N314</b> (Padlock not included)</p>	<p><b>Bul. 800T/H</b>  <b>Push-Pull Padlocking Attachment</b>            For 2-position push-pull and push-pull/twist release illuminated and non-illuminated operators. Use on standard head only (40 mm dia.). Locks the normally closed contacts open only. Conversion of normally closed late break contacts to standard normally closed contacts are recommended when using this accessory. Made of stainless steel.</p>	<p>800T-N314</p>
 <p><b>Cat. No. 800T-N163</b> (Padlock not included)</p>	<p><b>Bul. 800T/H</b>  <b>Padlocking Cover</b>            Guards against unauthorized operation for non-illuminated, standard knob selector switches and potentiometers. Stainless steel and clear plastic construction.</p>	<p>800T-N163</p>
	<p><b>Bul. 800T/H</b>  <b>Trigger Action Padlocking Attachment</b>            For 2-position trigger action E-stops with 45 mm heads.</p>	<p>800T-N378</p>











Locking Attachments, Continued

	Description		Cat. No.																									
 Cat. No. 800H-N140 (Padlock not included)	<b>Bul. 800T/H                      Padlocking Cover</b> Guards against unauthorized operation. For non-illuminated push buttons, 2-position push-pull or twist-release units, and standard knob selector switches. When applying Cat. No. 800H-N140 on 2-position maintained push-pull units, cover will lock only when the button is in depressed position. Padlocking cover includes blank legend plate for customer marking. <b>Note:</b> A pre-marked legend plate is available. The words OPEN COVER TO OPERATE are on the front and PULL-TO-START-PUSH-TO-STOP are on the rear. To order legend plate only, specify Cat. No. 800H-W174L.		800H-N140																									
 Cat. No. 800T-NX446 (Padlock not included)	<b>Bul. 800T                      2- and 3-Position Non-illuminated Selector Switch Padlocking Attachment — Standard Knob</b> Padlocking guard for 2- and 3-position selector switches with standard knob operators only. Locks selector switch in any maintained position.*		800T-NX446																									
 Cat. No. 800H-N141R (Padlock not included)	<table border="1"> <thead> <tr> <th data-bbox="532 701 1065 730">Description</th> <th data-bbox="1065 701 1333 730">Position</th> <th data-bbox="1333 701 1481 730">Cat. No.</th> </tr> </thead> <tbody> <tr> <td data-bbox="532 730 1065 787" rowspan="2"> <b>Bul. 800H                              2- and 3-Position Selector Switch with Padlocking Guards</b>                              Padlocking guard for 2- and 3-position selector switches with standard knob operators only.                         </td> <td data-bbox="1065 730 1333 760">Left</td> <td data-bbox="1333 730 1481 760">800H-N141L</td> </tr> <tr> <td data-bbox="1065 760 1333 787">Center</td> <td data-bbox="1333 760 1481 787">800H-N141C</td> </tr> <tr> <td data-bbox="532 787 1065 947" rowspan="2"> <b>Bul. 800H                              2- and 3-Position Selector Switch with Padlocking Guards</b>                              Padlocking guard for 2- and 3-position selector switches with standard knob operators only.                         </td> <td data-bbox="1065 787 1333 898">Right</td> <td data-bbox="1333 787 1481 898">800H-N141R</td> </tr> <tr> <td data-bbox="1065 898 1333 947">All</td> <td data-bbox="1333 898 1481 947">800H-N141A</td> </tr> </tbody> </table>	Description	Position	Cat. No.	<b>Bul. 800H                              2- and 3-Position Selector Switch with Padlocking Guards</b> Padlocking guard for 2- and 3-position selector switches with standard knob operators only.	Left	800H-N141L	Center	800H-N141C	<b>Bul. 800H                              2- and 3-Position Selector Switch with Padlocking Guards</b> Padlocking guard for 2- and 3-position selector switches with standard knob operators only.	Right	800H-N141R	All	800H-N141A														
Description	Position	Cat. No.																										
<b>Bul. 800H                              2- and 3-Position Selector Switch with Padlocking Guards</b> Padlocking guard for 2- and 3-position selector switches with standard knob operators only.	Left	800H-N141L																										
	Center	800H-N141C																										
<b>Bul. 800H                              2- and 3-Position Selector Switch with Padlocking Guards</b> Padlocking guard for 2- and 3-position selector switches with standard knob operators only.	Right	800H-N141R																										
	All	800H-N141A																										
 Cat. No. 800T-NX446A (Padlock not included)	<b>Bul. 800T                      4-Position Selector Switch Attachment — Standard Knob</b> Kit includes selector switch and guard (padlock not included). Padlocking guard for 4-position selector switches with standard knob operators only. Locks selector switch in any maintained position.*		800T-NX446A																									
 Cat. No. 800H-N316J (Padlock not included)	<table border="1"> <thead> <tr> <th data-bbox="532 1173 1065 1203">Description</th> <th data-bbox="1065 1173 1333 1203">Position</th> <th data-bbox="1333 1173 1481 1203">Cat. No.</th> </tr> </thead> <tbody> <tr> <td data-bbox="532 1203 1065 1570" rowspan="10"> <b>Bul. 800T/H                              Non-Illuminated Selector Switch Padlocking Attachment</b>                              2-, 3-, and 4-position selector switch padlocking attachments. Can be used to lock operators in a desired position. For 3-position selector switches, this device can also be used to lock out a left or right position as shown in the photo to the left.                         </td> <td colspan="2" data-bbox="1065 1203 1333 1232">For 2- and 3-Position Selector Switches</td> </tr> <tr> <td data-bbox="1065 1232 1333 1262">Left</td> <td data-bbox="1333 1232 1481 1262">800T-N316L</td> </tr> <tr> <td data-bbox="1065 1262 1333 1291">Center</td> <td data-bbox="1333 1262 1481 1291">800T-N316C</td> </tr> <tr> <td data-bbox="1065 1291 1333 1320">Right</td> <td data-bbox="1333 1291 1481 1320">800T-N316R</td> </tr> <tr> <td data-bbox="1065 1320 1333 1350">Window Center through Right - Prevent Left Operation</td> <td data-bbox="1333 1320 1481 1350">800T-N316J</td> </tr> <tr> <td data-bbox="1065 1350 1333 1379">Window Center through Left - Prevent Right Operation</td> <td data-bbox="1333 1350 1481 1379">800T-N316K</td> </tr> <tr> <td colspan="2" data-bbox="1065 1379 1333 1409">For 4-Position Selector Switches</td> </tr> <tr> <td data-bbox="1065 1409 1333 1438">Left (Pos. 1)</td> <td data-bbox="1333 1409 1481 1438">800T-N317L</td> </tr> <tr> <td data-bbox="1065 1438 1333 1467">Center Left (Pos. 2)</td> <td data-bbox="1333 1438 1481 1467">800T-N317CL</td> </tr> <tr> <td data-bbox="1065 1467 1333 1497">Center Right (Pos. 3)</td> <td data-bbox="1333 1467 1481 1497">800T-N317CR</td> </tr> <tr> <td data-bbox="1065 1497 1333 1526">Right (Pos. 4)</td> <td data-bbox="1333 1497 1481 1526">800T-N317R</td> </tr> </tbody> </table>	Description	Position	Cat. No.	<b>Bul. 800T/H                              Non-Illuminated Selector Switch Padlocking Attachment</b> 2-, 3-, and 4-position selector switch padlocking attachments. Can be used to lock operators in a desired position. For 3-position selector switches, this device can also be used to lock out a left or right position as shown in the photo to the left.	For 2- and 3-Position Selector Switches		Left	800T-N316L	Center	800T-N316C	Right	800T-N316R	Window Center through Right - Prevent Left Operation	800T-N316J	Window Center through Left - Prevent Right Operation	800T-N316K	For 4-Position Selector Switches		Left (Pos. 1)	800T-N317L	Center Left (Pos. 2)	800T-N317CL	Center Right (Pos. 3)	800T-N317CR	Right (Pos. 4)	800T-N317R	
Description	Position	Cat. No.																										
<b>Bul. 800T/H                              Non-Illuminated Selector Switch Padlocking Attachment</b> 2-, 3-, and 4-position selector switch padlocking attachments. Can be used to lock operators in a desired position. For 3-position selector switches, this device can also be used to lock out a left or right position as shown in the photo to the left.	For 2- and 3-Position Selector Switches																											
	Left	800T-N316L																										
	Center	800T-N316C																										
	Right	800T-N316R																										
	Window Center through Right - Prevent Left Operation	800T-N316J																										
	Window Center through Left - Prevent Right Operation	800T-N316K																										
	For 4-Position Selector Switches																											
	Left (Pos. 1)	800T-N317L																										
	Center Left (Pos. 2)	800T-N317CL																										
	Center Right (Pos. 3)	800T-N317CR																										
Right (Pos. 4)	800T-N317R																											
 Cat. No. 800H-N4162L (Padlock not included)	<table border="1"> <tbody> <tr> <td data-bbox="532 1570 1065 1875" rowspan="10"> <b>Bul. 800T/H                              Illuminated Selector Switch Padlocking Attachment</b>                              2- and 3-position selector switch padlocking attachments for illuminated selector switches.                               Stainless steel material                         </td> <td colspan="2" data-bbox="1065 1570 1333 1600">For 2-Position Selector Switches</td> </tr> <tr> <td data-bbox="1065 1600 1333 1629">Left</td> <td data-bbox="1333 1600 1481 1629">800T-N4162L</td> </tr> <tr> <td data-bbox="1065 1629 1333 1659">Right</td> <td data-bbox="1333 1629 1481 1659">800T-N4162R</td> </tr> <tr> <td colspan="2" data-bbox="1065 1659 1333 1688">For 3-Position Selector Switches</td> </tr> <tr> <td data-bbox="1065 1688 1333 1717">Left</td> <td data-bbox="1333 1688 1481 1717">800T-N4163L</td> </tr> <tr> <td data-bbox="1065 1717 1333 1747">Center</td> <td data-bbox="1333 1717 1481 1747">800T-N4163C</td> </tr> <tr> <td data-bbox="1065 1747 1333 1776">Right</td> <td data-bbox="1333 1747 1481 1776">800T-N4163R</td> </tr> <tr> <td data-bbox="1065 1776 1333 1806">Window Center through Right - Prevent Left Operation</td> <td data-bbox="1333 1776 1481 1806">800T-N4163J</td> </tr> <tr> <td data-bbox="1065 1806 1333 1835">Window Center through Left - Prevent Right Operation</td> <td data-bbox="1333 1806 1481 1835">800T-N4163K</td> </tr> </tbody> </table>	<b>Bul. 800T/H                              Illuminated Selector Switch Padlocking Attachment</b> 2- and 3-position selector switch padlocking attachments for illuminated selector switches.  Stainless steel material	For 2-Position Selector Switches		Left	800T-N4162L	Right	800T-N4162R	For 3-Position Selector Switches		Left	800T-N4163L	Center	800T-N4163C	Right	800T-N4163R	Window Center through Right - Prevent Left Operation	800T-N4163J	Window Center through Left - Prevent Right Operation	800T-N4163K								
<b>Bul. 800T/H                              Illuminated Selector Switch Padlocking Attachment</b> 2- and 3-position selector switch padlocking attachments for illuminated selector switches.  Stainless steel material	For 2-Position Selector Switches																											
	Left		800T-N4162L																									
	Right		800T-N4162R																									
	For 3-Position Selector Switches																											
	Left		800T-N4163L																									
	Center		800T-N4163C																									
	Right		800T-N4163R																									
	Window Center through Right - Prevent Left Operation		800T-N4163J																									
	Window Center through Left - Prevent Right Operation		800T-N4163K																									




\* Diameter of hasp is 11/32 in. (8.73 mm)

**Guards**

	Description	Type	Cat. No.
 Cat. No. <b>800T-N13</b>	<b>Bul. 800T Push Button Guards</b> Momentary push button guards to reduce the risk of accidental operation.	1 in. guard for non-illuminated	<b>800T-N13</b>
		1/2 in. guard for non-illuminated	<b>800T-N143</b>
		1-1/2 in. guard for illuminated	<b>800T-N93</b>
		1-1/2 in. guard for non-illuminated with locking attachment	800T-N39
 Cat. No. <b>800H-N152</b>	<b>Bul. 800H Illuminated Push Button Guard</b> This guard provides additional protection against accidental operation of the push button unit. 1-1/2 in. (38.1 mm) guard for illumination units.		<b>800H-N152</b>
 Cat. No. <b>800T-N226</b>	<b>Bul. 800T 18 mm Guard</b> Provides side protection for 18 mm pilot lights.		<b>800T-N226</b>
 Cat. No. <b>800H-N153</b>	<b>Bul. 800H Stainless Steel Guard</b> Used on non-illuminated push buttons that have protective boots as shown on page 10-39.		<b>800H-N153</b>
 Cat. No. <b>800T-N129</b>	<b>Bul. 800T Mushroom Push Button Guards</b> Momentary mushroom guards for standard and jumbo mushroom push buttons. Reduces the risk of accidental operation.	Standard guard	<b>800T-N129</b>
		Standard guard with set screw	<b>800T-N165</b>
		Jumbo guard	<b>800T-N151</b>
		Jumbo guard with set screw	<b>800T-N154</b>
 Cat. Nos. <b>800T-N310 and 800T-NX1320</b>	<b>Bul. 800T/H Protective Guard</b> Protective ring for Bul. 800T 2-position push-pull operators. Illuminated or non-illuminated. Often used to avoid unintentional tripping of E-stop operators. This guard is used with standard size button (40 mm dia.).	Stainless steel	<b>800T-N310</b>
		Black	<b>800T-NX1320</b>
 Cat. No. <b>800T-N310J</b>	<b>Bul. 800T/H Jumbo Protective Guard</b> Protective ring for Bul. 800T 2-position push-pull operators. Illuminated or non-illuminated. Often used to avoid unintentional tripping of E-stop operators.	60 mm (Jumbo)	<b>800T-N310J</b>
		63 mm	800T-N310L
Cat. No. <b>800T-N381</b>	<b>Bul. 800T/H Protective Guard</b> Protective ring for Bul. 800T trigger action E-stop operators.	45 mm	800T-N381
 Cat. No. <b>800T-N339</b>		<b>Bul. 800T/H Ramp Guard</b> For Bul. 800T/800H 2- and 3-position illuminated and non-illuminated push-pull units. Standard size button only (40 mm dia.).	60/63 mm


**Replacement Lamps**

**Pilot Lights, Illuminated Push Buttons, Illuminated Push-Pull, Illuminated Push-Pull/Twist to Release, and Illuminated Selector Switches**

Lamp	Type	Current, Typical	Lamp Voltage	ANSI No.	Catalog Voltage Code	Cat. No.
	Full Voltage Transformer	150 mA/250 mA	6.3V AC	755/1866	6, 16, 26, 36, 46, 56, 76	* <b>800T-N65</b>
	Full Voltage	80 mA	14V AC/DC	756	12	* 800T-N141
		70 mA	24V AC/DC	757	24	* <b>800T-N157</b>
		50 mA	48V AC/DC	1835	48	* 800T-N365
	Full Voltage Resistor	22 mA	120V AC/DC	949	10, 11	* <b>800T-N169</b>
	Flashing	150 mA	6V AC/DC	267	6	* <b>800T-N212</b>
		57 mA	24V AC/DC	24 MB	24	* 800T-N180
Dual Input Diode	21 mA	120V AC	90 MB	16	* 800T-N261	
Neon 	—	2 mA	120V AC/DC	B2A	10, 20	<b>609-N9</b>
<b>Lamp</b>	<b>Type</b>	<b>Current, Typical*</b>	<b>Lamp Voltage</b>	<b>Leakage Current</b>	<b>Code</b>	<b>Cat. No.*</b>
	Universal	13 mA @ 24V DC 8.5 mA @ 120V AC†	3V‡	3 mA	2	800T-N376x
	Transformer	60	6V	14 mA	16, 26, 46, 56	800T-N377x



- \* Item is sold in multiples of 5. Order quantity of 5 to receive package of 5 pieces.
- \* To complete the cat. no. replace the **x** with the first letter of the desired color: **Green**, **Red**, or **White**.
- † Typical current consumption values indicated are relative to the input of the power module.
- ‡ Lamp is intended for use with power module Cat. No. 800TC-N374 which has an input voltage rating of 12 ...130V AC/DC.

**Legacy LED Lamps\***

Lamp	Type	Current, Typical>	Lamp Voltage	Leakage Current	Catalog Voltage Code	Cat. No.*
	Full Voltage	13 mA/22 mA	12V AC/DC	3 mA	12	800T-N362x
		20 mA/21 mA	24V AC/DC	3 mA	24	800T-N319x
		12 mA/17 mA	32V AC/DC	3 mA	32	800T-N363x
		9 mA/14 mA	48V AC/DC	3 mA	48	800T-N364x
		3.3 mA/6 mA	120V AC	—	10	800T-N320x
		4.5 mA/6.2 mA	130V AC/DC	3 mA	13	800T-N321x
	Transformer	50 mA	6V AC	14 mA	6, 16, 26, 36, 46, 56, 76	800T-N318x
Flashing	18 mA	24V AC/DC	—	N/A	+ 800T-N319Fx	

- \* In full voltage applications, these lamps are intended to be used with power module Cat. No. 800T-N330.
- ❖ All LEDs except 120V have an internal shunt resistor for use with solid-state outputs. LEDs will not illuminate below listed leakage current.
- > Typical current draw varies with LED color. The first mA value is for a green or blue LED and the second mA value is for a red or amber LED.
- \* To complete the cat. no. replace the **x** with the first letter of the desired color: **Amber**, **Green**, **Red**, **Blue**, or **White**. White LEDs only available in 6V, 24V, 120V, and 130V.
- + Flashing rate is 2 Hz.

**Cluster Pilot Lights**

Lamp	Type	Current, Typical	Lamp Voltage	ANSI No.	Cat. No.*
	Full Voltage Transformer	195 mA	6V AC/DC	381	<b>800T-N258</b>
	Full Voltage	73 mA	12V AC/DC	382	800T-N259
		37 mA	24V AC/DC	387	<b>800T-N260</b>
<b>Lamp</b>	<b>Type</b>	<b>Current, Typical</b>	<b>Lamp Voltage</b>	<b>Polarity</b>	<b>Cat. No.*</b>
	Full Voltage Transformer	45 mA	6V AC/DC	Positive	800T-N340x
	Full Voltage	36 mA	12V AC/DC	Positive	800T-N341x
		14 mA	28V AC/DC	Bi-Polar	11 <b>800T-N80x</b>

- \* Item is sold in multiples of 5. Order quantity of 5 to receive package of 5 pieces.
- \* To complete the cat. no., replace the **x** with the first letter of the desired color: **Amber**, **Green**, or **Red** only.
- 11 For use with 24V AC/DC rated devices.

**Replacement Keys for Cylinder Lock 2-, 3-, and 4-Position Selector Switches (800T only)**

Cylinder Lock Key Option Code	Series Key Number	Cat. No.	Cylinder Lock Key Option Code	Series Key Number	Cat. No.
Blank (standard key)	D018 (standard key)	<b>X-181170</b>	15	T112*	40269-087-01
03	D020*	<b>X-307922</b>	16	T115*	40269-087-02
04	D025*	<b>X-307923</b>	17	T324*	40269-087-03
05	D335*	<b>X-307924</b>	18	T382*	40269-087-04
06	D429*	<b>X-307925</b>	19	T404*	40269-087-05
07	D461*	<b>X-307926</b>	20	T171*	40269-087-06
08	D111*	X-307927	21	T484*	40269-087-07
09	D587*	X-307928	22	T547*	40269-087-08
10	D682*	X-307929	23	T569*	40269-087-09
11	D713*	X-307930	24	T692*	40269-087-10
12	D900*	<b>X-307931</b>	25	T752*	40269-087-11
13	D992*	X-307932	26	T178*	40269-087-12
14	D118*	X-307933			

\* Uses master key DM81, AB Cat. No. X-433358.

\* Uses master key 15T, AB Cat. No. X-433359.

**Replacement Keys for Push Button Switches with Cylinder Locks (800T only)**

Lock Key Option Code			Series Key Number	Cat. No.
Spring Bolt	Dead Bolt A	Dead Bolt B		
Blank (standard key)	Blank (standard key)	Blank (standard key)	E158 (standard key)	<b>X-144218</b>
44	32	20	E109	X-386233
45	33	21	E131	X-386234
46	34	22	E100	X-386235
47	35	23	E115	X-386236
48	36	24	E120	X-386237
49	37	25	E104	X-386238
50	38	26	E108	X-386239
51	39	27	E132	X-386240
52	40	28	E144	X-386241
53	41	29	E157	X-386242
54	42	30	E101	X-386243
55	43	31	E102	40274-250-01
66	61	56	E106	40274-250-07
67	62	57	E111	40274-250-02
68	63	58	E117	40274-250-14
69	64	59	E125	40274-250-21
70	65	60	E130	40274-250-26



Blank and Custom Legend Plates — Aluminum, Type 4/13 (800T)

Blank/Custom Legend Plates



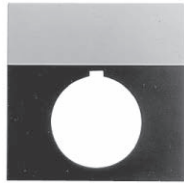
Standard Legend Plate



Jumbo Legend Plate

Legend Plate Color	Standard	Jumbo
	Cat. No.	Cat. No.
Grey	800T-X559	800T-X559J
Red	800T-X621	800T-X621J
Yellow	800T-X679	800T-X679J
Grey (with custom text)	800T-X559E	800T-X559JE
Red (with custom text)	800T-X621E	800T-X621JE
Yellow (with custom text)	800T-X679E	800T-X679JE

Specialty Legend Plates



Automotive Legend Plate



Half Round Legend Plate

Legend Plate Color	Automotive	Half Round*
	Cat. No.	Cat. No.
Grey (blank)	800T-X700	800T-X59
Red (blank)	800T-X701	800T-X121
Grey (with custom text)	800T-X700E	800T-X59E
Red (with custom text)	800T-X701E	800T-X121E

Note: Include text with custom legends.

\* All half round legend plates must be ordered in quantities of 25.

Custom Text Guidelines

Legend Size	No. of Lines	Max. No. of Characters per Line
Standard	1 line of	14
	2 lines of	14
Jumbo	5 lines	14
Automotive	4 lines	20

Custom Legend Plates for 4-Way Toggle and Cluster Pilot Lights

Legend Size	Cat. No.‡	Color	Text Options*
Standard	800T-X619E	Aluminum (with custom text)	2 lines of up to 14 characters on top 1 line of up to 14 characters on bottom
			1 vertical line of up to 7 characters on left side 1 vertical line of up to 7 characters on right side
			1 vertical line of up to 9 characters on left side 1 vertical line of up to 9 characters on right side

\* Rule sets listed are mutually exclusive; only one can be chosen.

‡ For blank toggle or cluster pilot legend, order Cat. No. 800T-X619.

Blank and Custom Legend Plates — Aluminum, Type 4/13 (800T), Continued  
 Specialty Legend Plates



Cat. No. **800T-X618**



Cat. No. **800T-X647Y**



Cat. No. **800T-X646**

Type	Start/Stop Legend Plates		Emergency Stop Legend Plates	
	Grey	Yellow	Yellow (Large Size)	Yellow IEC Ring
	Cat. No.	Cat. No.	Cat. No.	Cat. No.
Push-to-Stop Pull-to-Start or Push-to-Stop Twist or Pull Release	<b>800T-X618</b>	<b>800T-X618Y</b>	<b>800T-X647Y</b>	—
Blank	—	—	<b>800T-X645Y</b>	<b>800T-X646</b>
Custom	—	—	800T-X645YE	—
Emergency Stop	—	—	—	<b>800T-X646EM</b>

Potentiometer Legend Plates



Cat. No. **800T-X609**



Cat. No. **800T-X608**

Type	Cat. No.
Potentiometer with graduated markings	* <b>800T-X609</b>
SPEED	<b>800T-X608</b>

\* For graduated markings with a custom text, order Cat. No. 800T-X609E and specify up to two lines of text, 14 characters per line.

18 mm Legend Plates



**Type A Legend Plate**  
 Cat. No. **800T-N515**

Description	Cat. No.
Blank	
Type A	<b>800T-N515</b>
Type B	<b>800T-N516</b>
With Custom Marking*	
Type A with Text	800T-N515E
Type B with Text	800T-N516E

\* Text must be supplied.

Custom Text Guidelines

Legend Type	Number of Lines	Maximum Number of Characters per Line
A	1	9
B	2	13



Standard Legend Plates – Aluminum, Type 4/13 (Bul. 800T)



Standard Legend Plate



Jumbo Legend Plate

Marking	Standard	Jumbo	Marking	Standard	Jumbo
	Cat. No.	Cat. No.		Cat. No.	Cat. No.
AUTO-OFF-HAND	<b>800T-X501</b>	800T-X501J	ON-OFF	<b>800T-X622</b>	800T-X622J
AUTO-MAN-OFF	<b>800T-X625</b>	800T-X625J	OPEN	<b>800T-X531</b>	800T-X531J
CLOSE	<b>800T-X502</b>	800T-X502J	OPEN-CLOSE	<b>800T-X532</b>	800T-X532J
CYCLE START	<b>800T-X562</b>	800T-X562J	OPEN-OFF-CLOSE	<b>800T-X533</b>	800T-X533J
DOWN	<b>800T-X503</b>	800T-X503J	OUT	<b>800T-X534</b>	800T-X534J
EMERG. STOP (Yellow)	<b>800T-X504Y</b>	—	POWER ON	<b>800T-X639</b>	800T-X639J
EMERG. STOP (Red)*	<b>800T-X504</b>	<b>800T-X504J</b>	RAISE	<b>800T-X535</b>	800T-X535J
EMERGENCY STOP (Red)*	<b>800T-X648</b>	<b>800T-X648J</b>	RAISE-LOWER	<b>800T-X536</b>	800T-X536J
FAST	<b>800T-X505</b>	800T-X505J	RAISE-OFF-LOWER	<b>800T-X537</b>	800T-X537J
FEED START	<b>800T-X566</b>	800T-X566J	RESET	<b>800T-X538</b>	800T-X538J
FEED STOP	<b>800T-X567</b>	800T-X567J	REVERSE	<b>800T-X539</b>	800T-X539J
FOR.-REV.	<b>800T-X506</b>	800T-X506J	RUN	<b>800T-X540</b>	800T-X540J
FOR.-OFF-REV.	<b>800T-X507</b>	800T-X507J	RUN-INCH	800T-X634	800T-X634J
FORWARD	<b>800T-X508</b>	800T-X508J	RUN-JOG	<b>800T-X541</b>	<b>800T-X541</b>
FOURTH SPEED	800T-X624	800T-X624J	SAFE-RUN	<b>800T-X542</b>	800T-X542J
FULL SPEED	<b>800T-X509</b>	800T-X509J	SECOND SPEED	800T-X543	800T-X543J
HAND-AUTO	<b>800T-X510</b>	800T-X510J	SPEED* <sup>‡</sup>	<b>800T-X608</b>	—
HAND-OFF-AUTO	<b>800T-X511</b>	800T-X511J	SLOW	<b>800T-X544</b>	800T-X544J
HIGH	<b>800T-X512</b>	800T-X512J	SLOW-FAST	<b>800T-X545</b>	800T-X545J
HIGH-LOW	<b>800T-X513</b>	800T-X513J	SLOW-OFF-FAST	<b>800T-X546</b>	800T-X546J
HIGH-OFF-LOW	<b>800T-X514</b>	800T-X514J	START	<b>800T-X547</b>	800T-X547J
IN	<b>800T-X515</b>	800T-X515J	START-JOG	<b>800T-X548</b>	800T-X548J
INCH	<b>800T-X516</b>	800T-X516J	START-STOP	<b>800T-X549</b>	800T-X549J
JOG	<b>800T-X517</b>	800T-X517J	STOP (Red)	<b>800T-X550</b>	<b>800T-X550J</b>
JOG FORWARD	<b>800T-X518</b>	800T-X518J	STOP-START	<b>800T-X551</b>	800T-X551J
JOG REVERSE	<b>800T-X519</b>	800T-X519J	SUMMER-OFF-WINTER	800T-X553	800T-X553J
JOG RUN	<b>800T-X520</b>	800T-X520J	SUMMER-WINTER	800T-X552	800T-X552J
JOG-SAFE-RUN	<b>800T-X522</b>	800T-X522J	TEST	<b>800T-X554</b>	800T-X554J
JOG-STOP-RUN	<b>800T-X521</b>	800T-X521J	THIRD SPEED	800T-X555	800T-X555J
LEFT-RIGHT	<b>800T-X523</b>	800T-X523J	UP	<b>800T-X556</b>	800T-X556J
LOCAL-REMOTE	<b>800T-X638</b>	800T-X638J	UP-DOWN	<b>800T-X557</b>	800T-X557J
LOW	<b>800T-X524</b>	800T-X524J	UP-OFF-DOWN	<b>800T-X558</b>	800T-X558J
LOW SPEED	800T-X525	800T-X525J	O (Red)	800T-X640	800T-X640J
LOWER	<b>800T-X526</b>	800T-X526J	I	800T-X641	800T-X641J
OFF	<b>800T-X527</b>	800T-X527J	O I	800T-X642	800T-X642J
OFF-COOLANT-ON	<b>800T-X528</b>	800T-X528J	I O II	800T-X643	800T-X643J
OFF-ON	<b>800T-X529</b>	800T-X529J	—	—	—
ON	<b>800T-X530</b>	800T-X530J	—	—	—

\* These legend plates do not comply with E-Stop standards that specify a yellow background, such as IEC 60947-5-5 and NFPA 79.

<sup>‡</sup> Potentiometer type with graduated markings.

Legend Plates – Plastic, Type 4/4X/13 (800H)



**Standard Legend Plate**  
 Cat. No. 800H-W100



**Jumbo Legend Plate**  
 Cat. No. 800H-W100J



**Automotive Legend Plate**  
 Cat. No. 800H-W100A

Blank/Custom Legend Plates Type 4/4X

Legend Plate Color	Standard	Jumbo	Automotive
	Cat. No.	Cat. No.	Cat. No.
Grey (Blank)	<b>800H-W100</b>	<b>800H-W100J</b>	<b>800H-W100A</b>
Red (Blank)	<b>800H-W300</b>	<b>800H-W300J</b>	800H-W300A
White (Blank)	<b>800H-W500</b>	<b>800H-W500J</b>	<b>800H-W500A</b>
Yellow (Blank)	800H-W700	800H-W700J	<b>800H-W700A</b>
Grey (with Custom Text)	800H-W100E	800H-W100JE	800H-W100AE
Red (with Custom Text)	800H-W300E	800H-W300JE	800H-W300AE
White (with Custom Text)	800H-W500E	800H-W500JE	800H-W500AE
Yellow (with Custom Text)	800H-W700E	800H-W700JE	800H-W700AE

Note: Include text with custom legends.

Custom Text Guidelines

Legend Size	Number of Lines	Maximum Number of Characters per Line
Standard	1 Line of	13
	2 Lines of	13
Jumbo	5 Lines	13
Automotive	4 Lines	16



**Potentiometer Legend Plate**  
 Cat. No. 800H-W080

Potentiometer Legends

Legend Marking	Cat. No.
Graduated Markings Only	<b>800H-W080</b>
SPEED	<b>800H-W081</b>
Custom Legend with Graduated Marking	800H-W080E



Cat. No. **800H-W196**



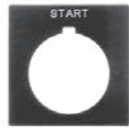
Cat. No. **800H-W797A**



Cat. No. **800H-W690**

Type	Start/Stop Legend Plates	Emergency Stop Legend Plates	
	Grey Cat. No.	Yellow (Large Size) Cat. No.	Yellow IEC Ring Cat. No.
Push-to-Stop Pull-to-Start	<b>800H-W196</b>	<b>800H-W797A</b>	—
Blank	—	<b>800H-W700A</b>	<b>800H-W690</b>
Custom	800H-W100E	800H-W700AE	—

Standard Legend Plates – Plastic, Type 4/4X/13 (800H)



Grey Legend Plate  
Type 4/4X



White Legend Plate  
Type 4/4X

Marking	Grey Type 4/4X	White Type 4/4X	Marking	Grey Type 4/4X	White Type 4/4X
	Cat. No.	Cat. No.		Cat. No.	Cat. No.
AUTO OFF HAND	<b>800H-W154</b>	800H-W554	LOWER	800H-W115	800H-W515
AUTO MAN OFF	800H-W059	800H-W459	MAN AUTO	<b>800H-W031</b>	800H-W431
CLOSE	<b>800H-W101</b>	800H-W501	MAN OFF AUTO	<b>800H-W062</b>	800H-W462
CYCLE START	800H-W006	800H-W406	MOTOR RUN	800H-W008	800H-W408
CYCLE STOP (Red)	<b>800H-W376</b>	—	MOTOR STOP (Red)	800H-W375	—
DECREASE	800H-W002	800H-W402	OFF	<b>800H-W116</b>	800H-W516
DOWN	<b>800H-W102</b>	800H-W502	OFF COOLANT ON	800H-W052	800H-W452
EMERG. STOP (Red)*	<b>800H-W372</b>	—	OFF LOC REMOTE	800H-W061	—
EMERGENCY STOP (Red)*	<b>800H-W373</b>	—	OFF MAN AUTO	800H-W060	800H-W460
FAST	800H-W104	800H-W504	OFF ON	<b>800H-W133</b>	<b>800H-W533</b>
FEED START	800H-W007	—	ON	<b>800H-W117</b>	<b>800H-W517</b>
FEED STOP (Red)	800H-W377	—	OPEN	<b>800H-W118</b>	800H-W518
FOR. REV.	800H-W132	800H-W532	OPEN CLOSE	<b>800H-W134</b>	800H-W534
FOR. OFF REV.	800H-W152	800H-W552	OPEN OFF CLOSE	800H-W153	800H-W553
FORWARD	<b>800H-W105</b>	800H-W505	OUT	800H-W119	800H-W519
FOURTH SPEED	800H-W010	—	POWER ON	<b>800H-W001</b>	800H-W401
FULL SPEED	800H-W106	800H-W506	PULL-TO-START	800H-W198	—
HAND AUTO	<b>800H-W131</b>	800H-W531	PUSH-TO-STOP (Red)	800H-W378	—
HAND OFF AUTO	<b>800H-W151</b>	<b>800H-W551</b>	RAISE	800H-W120	800H-W520
HIGH	800H-W107	800H-W507	RAISE LOWER	800H-W034	—
HIGH LOW	800H-W030	—	RAISE OFF LOWER	800H-W156	800H-W556
HIGH LOW OFF	800H-W058	—	RESET	<b>800H-W121</b>	<b>800H-W521</b>
HIGH OFF LOW	800H-W155	800H-W555	REVERSE	<b>800H-W122</b>	800H-W522
IN	800H-W108	800H-W508	RIGHT	800H-W005	800H-W405
INCH	800H-W109	800H-W509	RUN	<b>800H-W123</b>	800H-W523
INCREASE	800H-W003	—	RUN INCH	800H-W037	—
JOG	<b>800H-W110</b>	800H-W510	RUN JOG	800H-W032	—
JOG FORWARD	800H-W111	800H-W511	SAFE RUN	800H-W033	—
JOG REVERSE	800H-W112	800H-W512	SECOND SPEED	800H-W124	800H-W524
JOG RUN	800H-W135	800H-W535	SLOW	800H-W125	800H-W525
JOG SAFE RUN	800H-W051	—	SLOW FAST	800H-W136	800H-W536
JOG STOP RUN	800H-W057	—	SLOW OFF FAST	800H-W157	800H-W557
LEFT	800H-W004	800H-W404	SPEED*	<b>800H-W081</b>	800H-W481
LEFT RIGHT	800H-W036	—	SPEED*	800H-W182	—
LOC OFF REMOTE	800H-W055	800H-W455	START	<b>800H-W126</b>	<b>800H-W526</b>
LOW	800H-W113	800H-W513	START JOG	800H-W138	800H-W538
LOW HIGH	800H-W035	—	START JOG STOP	800H-W158	800H-W558
LOW OFF HIGH	800H-W056	—	START RUN STOP	800H-W054	—
LOW SPEED	800H-W114	800H-W514	START STOP	800H-W137	800H-W537

\* These legend plates do not comply with E-Stop standards that specify a yellow background, such as IEC 60947-5-5 and NFPA 79.

\* Potentiometer type with graduated markings.

Standard Legend Plates – Plastic, Type 4/4X/13 (800H)



**Grey Legend Plate**  
Type 4/4X



**White Legend Plate**  
Type 4/4X

Marking	Grey Type 4/4X	White Type 4/4X	Marking	Grey Type 4/4X	White Type 4/4X
	Cat. No.	Cat. No.		Cat. No.	Cat. No.
UP	<b>800H-W009</b>	800H-W409	STOP (Red)	<b>800H-W371</b>	—
UP DOWN	800H-W039	—	STOP RUN START	800H-W053	—
UP OFF DOWN	800H-W160	800H-W560	STOP START	800H-W038	800H-W438
<b>O</b> (Red)	800H-W184	—	SUMMER OFF WINTER	800H-W159	800H-W559
<b>O I</b>	800H-W185	800H-W582	SUMMER WINTER	800H-W139	800H-W539
<b>I</b>	800H-W181	800H-W581	TEST	<b>800H-W128</b>	800H-W528
<b>I O II</b>	800H-W183	800H-W583	THIRD SPEED	800H-W129	800H-W529

Flip Lever Legend Plates (for use with Series D operators)

Marking	Grey — Type 4/4X	Marking	Grey — Type 4/4X	Marking	Grey — Type 4/4X
	Cat. No.		Cat. No.		Cat. No.
Blank	<b>800H-W200</b>	LOW	800H-W213	RUN	800H-W223
Customer-Specified*	<b>800H-W200E</b>	BAS	800H-W213F	EN MARCHE	800H-W223F
CLOSE	800H-W201	LOW SPEED	800H-W214	SECOND SPEED	800H-W224
FERMER	800H-W201F	VITESSE MIN	800H-W214F	VITESSE 2	800H-W224F
DOWN	<b>800H-W202</b>	LOWER	800H-W215	SLOW	800H-W225
DESCENDRE	800H-W202F	ABAISSER	800H-W215F	LENT	800H-W225F
FAST	800H-W204	OFF	800H-W216	START	800H-W226
RAPIDE	800H-W204F	ARRÊTER	800H-W216F	MARCHE	800H-W226F
FORWARD	800H-W205	ON	800H-W217	TEST	800H-W228
AVANT	800H-W205F	DÉMARRER	800H-W217F	ESSAI	800H-W228F
FULL SPEED	800H-W206	OPEN	800H-W218	THIRD SPEED	800H-W229
VITESSE MAX	800H-W206F	OUVRIER	800H-W218F	VITESSE 3	800H-W229F
HIGH	800H-W207	OUT	800H-W219	I	800H-W281
HAUT	800H-W207F	SORTIR	800H-W219F	O	800H-W284
IN	800H-W208	RAISE	800H-W220	LEFT	800H-W286
ENTRER	800H-W208F	ÉLEVER	800H-W220F	GAUCHE	800H-W286F
INCH	800H-W209	RESET	800H-W221	RIGHT	800H-W287
POUCE	800H-W209F	RÉARMER	800H-W221F	DROITE	800H-W287F
JOG	800H-W210	REVERSE	800H-W222	UP	800H-W288
À COUPS	800H-W210F	ARRIERE	800H-W222F	EN HAUT	800H-W288F

\* 12 characters max.

10

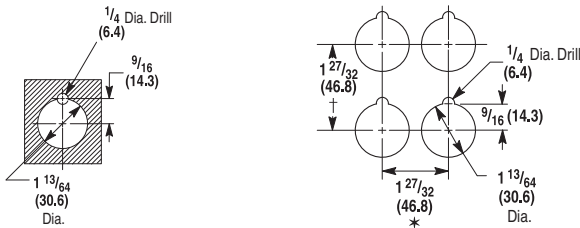
Marking	Red — Type 4/4X
	Cat. No.
Blank	800H-W400
Customer-Specified*	<b>800H-W400E</b>
EMERG. STOP	800H-W472
ARRÊT URGENT	800H-W472F
STOP	800H-W471
ARRET	<b>800H-W471F</b>
O	800H-W484

\* 12 characters max.

**Approximate Dimensions**

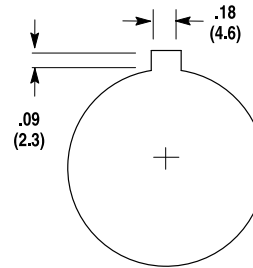
Dimensions in inches (millimeters). Dimensions are not intended to be used for manufacturing purposes.

**Mounting Instructions for Push Buttons with Shallow Blocks, Mini Blocks, Logic Reed Blocks, Sealed Switch Blocks, and Time Delay Blocks (see footnotes for exceptions)**



Sketch illustrates the minimum distance between centerlines when mounting Bulletin 800T/H controls either side-by-side, facing each other, or one above the other. When control units are mounted so that the contact block terminals face each other, the 2-1/4 in. (57.2 mm) dimension must be used in order to get proper electrical clearance. When control units are mounted so that the contact block terminals do not face each other, the 1-27/32 in. (46.8 mm) dimension can be used.

**Typical Panel Cut-Out**



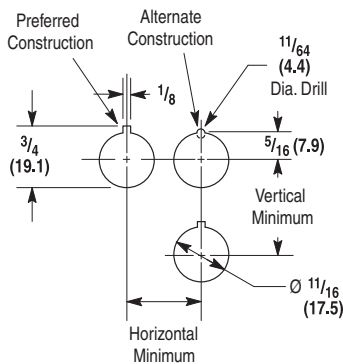
- \* Change to 2-1/4 in. (57.2 mm) for transformer type pilot light, push-to-test pilot lights, illuminated selector switches, and all push-pull buttons.  
**Note:** Large legend plate requires minimum horizontal spacing of 2-15/32 in. (62.7 mm).
- ⊛ Vertical minimum spacing dimension changes for the following legend plates: jumbo 2-15/32 in. (62.7 mm); large 2-7/16 in. (61.9 mm); cluster pilot light and 2-, 3-, 4-way switches 2-1/16 in. (52.4 mm).

**Panel Thickness** — Kits are shipped with three 1/16 in. (1.58 mm) gaskets. Refer to table below for number of washers required for various panel thicknesses.

	1/16 in. (1.6 mm) (16 Gauge)	7/64 in. (2.8 mm) (12 Gauge) 9/64 in. (3.6 mm) (10 Gauge)	3/16 in. (4.8 mm) Panel	Thicker Than 3/16 in. (4.8 mm) Panel	Thicker Than 1/4 in. (6.4 mm) Panel
<b>800T</b>	3 washers	2 washers	1 washer	Counterbore to 3/16 in. (4.8 mm)	Counterbore to 3/16 in. (4.8 mm)
<b>800H</b>	4 washers	3 washers	2 washers	1 washer	Counterbore to 1/4 in. (6.4 mm)

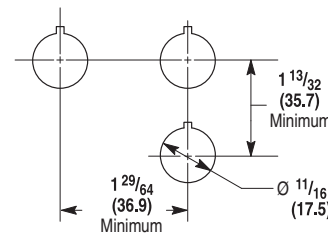
**Mounting Instructions for 18 mm Small Pilot Lights**

**Type A Legend Plate**



Cat. No. 800T-N515

**Type B Legend Plate**



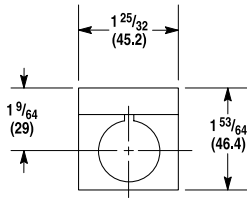
Device	Dimensions	
	Horizontal	Vertical
800T-PS, PSD, PST, QS, QST and RST	31/32 (24.6)	1-5/32 (29.4)
800T-PSDT	1-3/64 (26.6)	1-15/64 (31.4)

# 30.5 mm Push Buttons

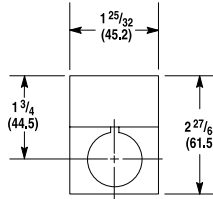
## Approximate Dimensions

Dimensions in inches (millimeters). Dimensions are not intended to be used for manufacturing purposes.

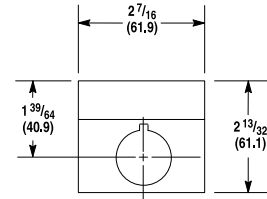
### Legend Plate Dimensions (Bul. 800T Only)



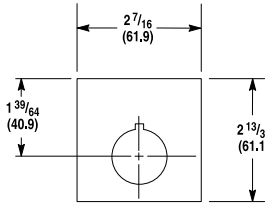
Standard Legend Plate



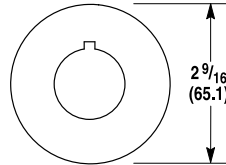
Jumbo Legend Plate



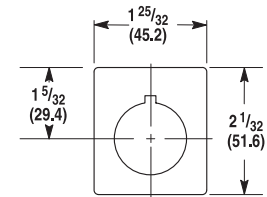
Large Legend Plate  
(Automotive Industry Type)



Large Size  
Push-Pull/Twist Legend Plate  
Cat. No. 800T-X647\*



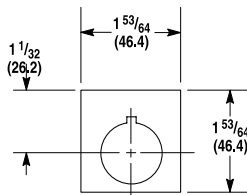
Round  
Cat. No. 800T-X646\*



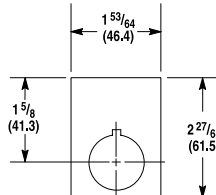
Cluster Pilot Light and  
2-3-4 Way Switch  
Silver Legend Plate  
Cat. No. 800T-X619

\* For panel mounting only. Not for use with Allen-Bradley enclosures.

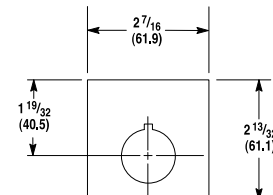
### Legend Plate Dimensions (Bul. 800H Only)



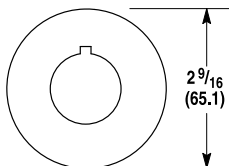
Type 4/4X  
Standard Legend Plate



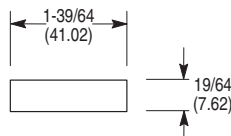
Type 4/4X  
Jumbo Legend Plate



Type 4/4X  
Large Legend Plate  
(Automotive Industry Type)



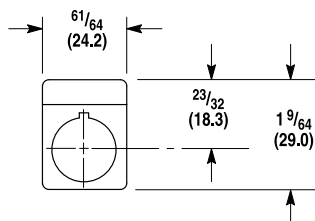
Type 4/4X  
Round



Type 4/4X  
Standard Legend Plate  
(Flip Lever Operators)

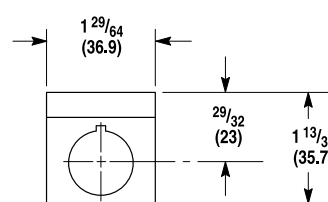
### Legend Plate Dimensions (Bul. 800T 18 mm Pilot Lights Only)

#### Legend Plate for Small Pilot Light Type A Legend



Cat. No. 800T-N515

#### Legend Plate for Small Pilot Light Type B Legend

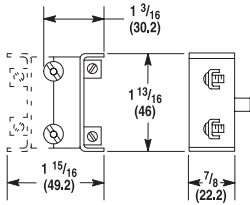


Cat. No. 800T-N516  
(Automotive Industry Type)

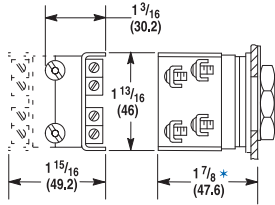


Dimensions in inches (millimeters). Dimensions are not intended to be used for manufacturing purposes.

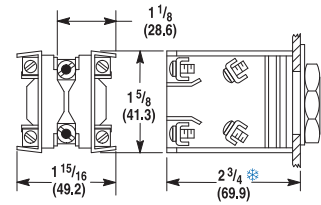
**Blocks (Bul. 800T Only)**



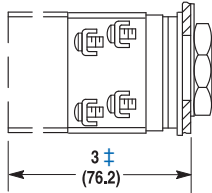
**Mini Contact Block**  
 7/8 (22.2) Deep



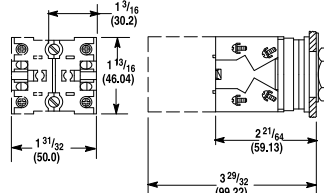
**Shallow, PenTUFF,  
 and Logic Reed Contact Blocks**  
 1-1/8 (28.6) Deep



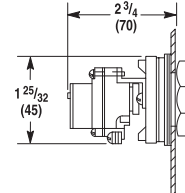
**Sealed Switch Block**  
 2 (50.8) Deep



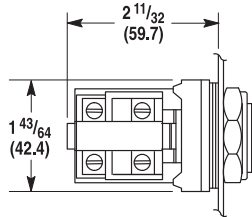
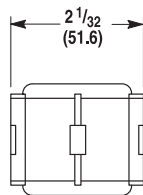
**Tandem Mounting**  
 (2 shallow contact  
 blocks stacked)



**Stackable Sealed Switch Block**  
 1.58 (40.1) Deep



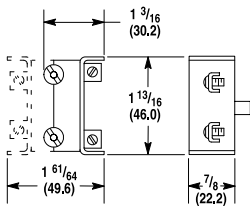
**Time Delay Contact Block**  
 (For Push Buttons Only)



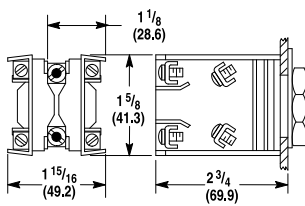
**Snap Action Contact Block (For Push Button Only)**

- \* Dimension shown is for push buttons. Selector switch dimension is 2-1/32 in. (51.6 mm).
- ⊛ Dimension shown is for push buttons. Selector switch dimension is 2-27/32 in. (72.2 mm).
- ‡ Dimension shown is for push buttons. Selector switch dimension is 3-5/32 in. (80.2 mm).

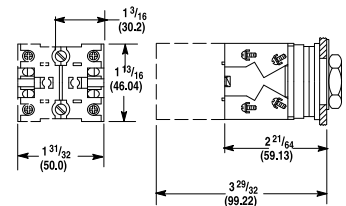
**Blocks (Bul. 800H Only)**



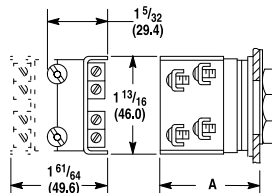
**Mini Contact Block**



**Sealed Switch Block**  
 2 (50.8) Deep



**Stackable Sealed Switch Block**  
 1.58 (40.1) Deep



**Shallow, PenTUFF and Logic  
 Reed Contact Blocks**

Dim.	Momentary Push Button	Maintained Push Button	Selector Switch
A	2 (50.8)	2 (50.8)	1-29/32 (48.4)

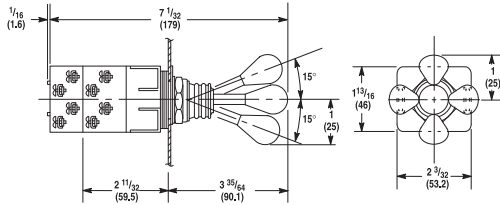
Operator Extension Behind Panel — When mounted with thrust washer, trim washer, or notched legend plate and correct number of rubber washers.

# 30.5 mm Push Buttons

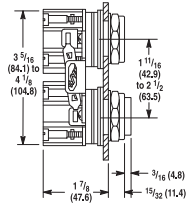
## Approximate Dimensions

Dimensions in inches (millimeters). Dimensions are not intended to be used for manufacturing purposes.

### Push Buttons and Switches (Bul. 800T Only)

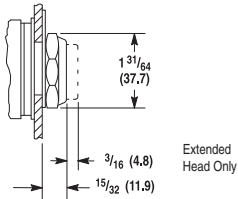


**2-3-4 Way Switch**  
**Shipping Wt. with 2 Contact Blocks 6 oz (0.17 kg)**  
**Shipping Wt. with 4 Contact Blocks 8-1/2 oz (0.24 kg)**

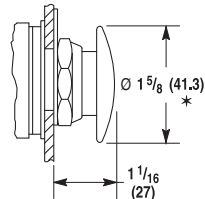


**Mechanically Interlocked Maintained Contact Push Button**  
**Shipping Wt. 1 lb (0.45 kg)**

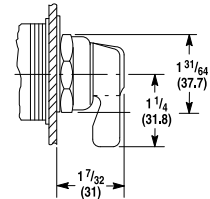
### Push Buttons and Pilot Lights



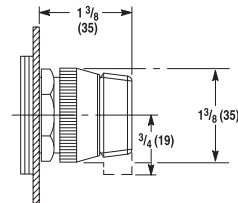
**Flush and Extended Head Push Button**  
**Shipping Wt. 5-1/2 oz (0.15 kg)**



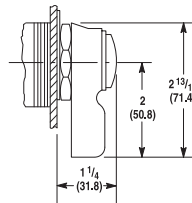
**Mushroom Head Push Button**  
**Shipping Wt. 7-1/2 oz (0.21 kg)**



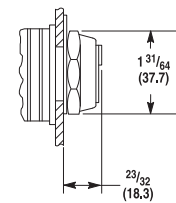
**Non-Illuminated Knob Lever and Standard Knob Selector Switch**  
**Shipping Wt. 6 oz (0.17 kg)**



**Illuminated Knob Lever and Standard Knob Selector Switch**  
**Shipping Wt. 6 oz (0.17 kg)**



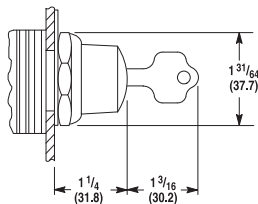
**Wing Lever Selector Switch**  
**Shipping Wt. 8 oz (0.22 kg)**



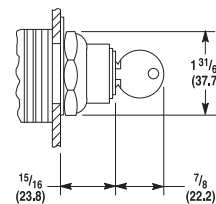
**Coin Slot Selector Switch**  
**Shipping Wt. 6 oz (0.17 kg)**

\* Except jumbo which is 2-1/4 (57.2).

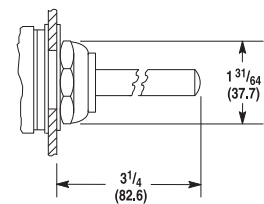
### Operator Extension in Front of Panel (Bul. 800T Only)



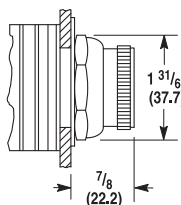
**Key Operated Selector Switch**  
**Shipping Wt. 12 oz (0.34 kg)**



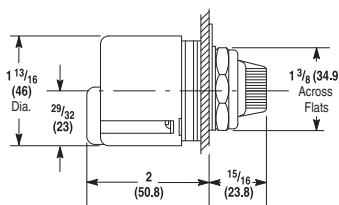
**Push Button with Cylinder Lock**  
**Shipping Wt. 12 oz (0.34 kg)**



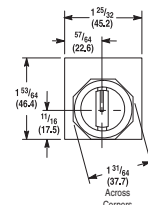
**Wobble Stick**  
**Shipping Wt. 9 oz (0.25 kg)**



**Selector Push Button**  
**Shipping Wt. 6 oz (0.17 kg)**

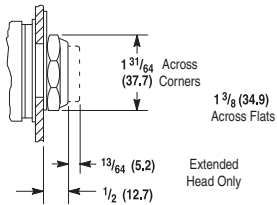


**Type J Potentiometer Unit**  
**Shipping Wt. 4 oz (0.11 kg)**

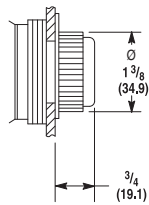


Dimensions in inches (millimeters). Dimensions are not intended to be used for manufacturing purposes.

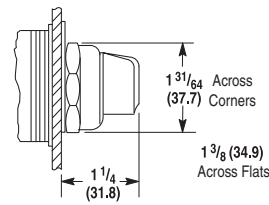
**Push Buttons and Switches (Bul. 800H Only)**



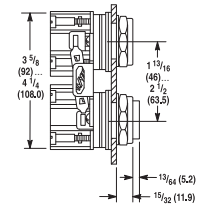
*Bootless Flush and Extended Head Momentary Contact Push Button*  
**Shipping Weight. 5-1/2 oz (0.16 kg)**



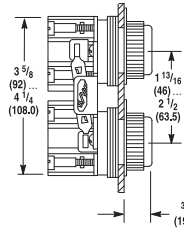
*Booted Flush and Extended Head Momentary Contact Push Button*  
**Shipping Weight. 5-1/2 oz (0.16 kg)**



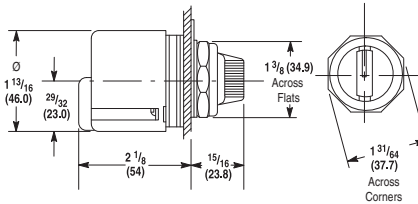
*Standard Knob Selector Switch Non-Illuminated*  
**Shipping Weight. 6 oz (0.17 kg)**



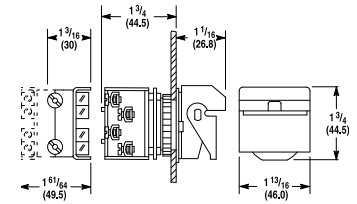
*Bootless Maintained Contact Push Buttons*



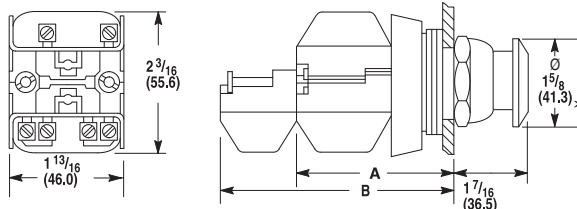
*Booted Maintained Contact Push Buttons*  
**Shipping Weight. 1 lb (0.45 kg)**



*Type J Potentiometer Unit*  
**Shipping Weight. 7 oz (0.20 kg)**



*Type 4 Flip Lever*  
**Shipping Weight. 8 oz (0.14 kg)**



**Mushroom Head — Maintained and Momentary**

**Non-Illuminated Mushroom and Push-Pull Push Buttons**

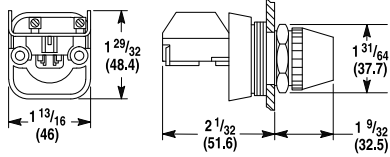
Cat. No. Suffix	Description	Dimensions		Shipping Weights
D4	One Shallow Block	A	2-1/32 (51.6)	5 oz (0.14 kg)
A1, A5 and A7	Two Shallow blocks	A	2-1/32 (51.6)	6 oz (0.17 kg)
B6	Two Shallow Blocks and Two Mini Blocks	B	2-7/8 (73.0)	8 oz (0.22 kg)

\* Jumbo versions are 2-1/4 (57.2).

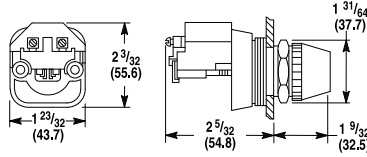
Bulletin 800T/H  
**30.5 mm Push Buttons**  
 Approximate Dimensions

Dimensions in inches (millimeters). Dimensions are not intended to be used for manufacturing purposes.

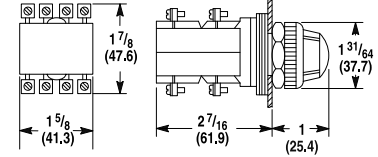
**Pilot Light and Illuminated Devices (Bul. 800T Only)**



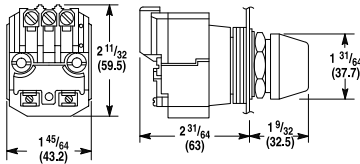
Full Voltage, Neon and Dual Input Pilot Light  
**Shipping Wt. 5 oz (0.14 kg)**



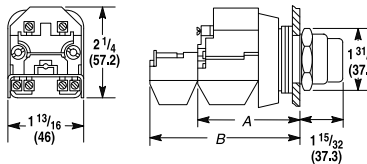
Transformer Type Pilot Light  
**Shipping Wt. 8 oz (0.22 kg)**



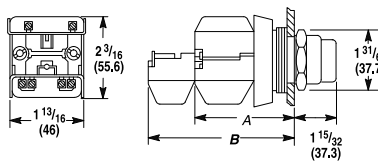
Cluster Pilot Light  
**Shipping Wt. 12 oz (0.34 kg)**



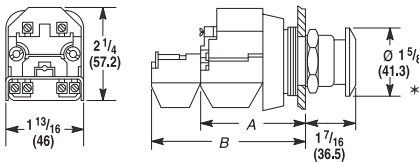
Dual Input Transformer Type Pilot Light



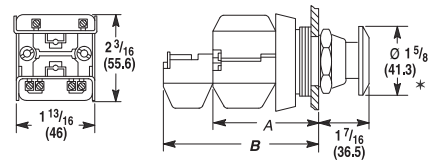
Transformer Type (Push-to-Test Pilot Light and Illuminated Push Button)



Full Voltage, Neon and Dual Input Type (Push-to-Test Pilot Light and Illuminated Push Button)



Push-Pull and Twist or Pull Release Units (Transformer Type Illuminated)



Push-Pull and Twist or Pull Release Units (Full Voltage, Neon and Dual Input Illuminated and All Non-Illuminated)

\* Jumbo mushroom versions are 2-1/4 in. (57.2 mm) diameter.

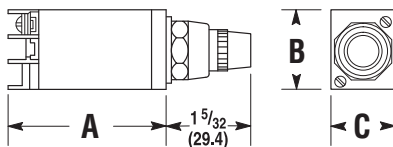
Push-to-Test Pilot Lights Illuminated Push Buttons and Illuminated Push-Pull Buttons							Non-Illuminated Push-Pull Buttons					
Cat. No. Suffix*	Description	Transformer Type		Full Voltage or Neon Type		Cat. No. Suffix	Description	Transformer Type				
		Dim.	Ship. Wt.	Dim.	Ship. Wt.			Dim.	Ship. Wt.			
D4	Transformer or Terminal Module and One Shallow Contact Block	A	2-5/32 (54.8)†	9 oz. (0.25 kg)	A	2-1/32 (51.6)	7 oz. (0.25 kg)	D4	One Shallow Contact Block	A	2-1/32 (51.6)	5 oz. (0.14 kg)
A1 and A7	Transformer or Terminal Module and One Shallow Block and One Mini Contact Block	B	2-7/8 (73)	10 oz. (0.28 kg)	B	2-7/8 (73)	8 oz. (0.22 kg)	A4 A5 A7	Two Shallow Contact Blocks	A	2-1/32 (51.6)	6 oz. (0.17 kg)
AP D1P D2P	Transformer or Terminal Module and One Sealed Switch Contact Block	A	3-1/32 (77)	10 oz. (0.28 kg)	A	2-29/32 (73.8)	8 oz. (0.22 kg)	B6	Two Shallow Blocks and Two Mini Contact Blocks	B	2-7/8 (73)	8 oz. (0.22 kg)

\* Applies to illuminated push-pull push buttons only.

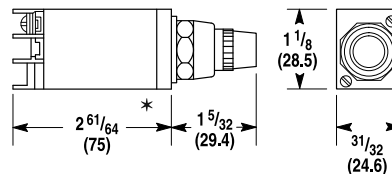
† Dual input type pilot light dimension is 2-13/32 in. (61.1 mm).

10

**18 mm Small Pilot Lights**



Small Pilot Light Including Push-To-Test  
**Shipping Weight 3 oz (0.08 kg)**



Small Pilot Light Dual Input (Diode)  
**Shipping Weight 3 oz (0.08 kg)**

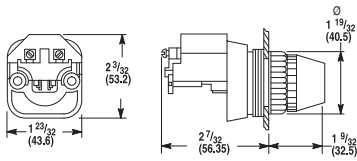
Device	A	B	C
800T-PS, -PSD, -PST, -QS, -QST, and -RST	2-1/4 (57.2)	1-1/16 (27)	27/32 (21.4)
800T-PSDT	2-61/64 (75)	1-15/64 (31.4)	31/32 (24.6)

\* Transfer dual input pilot light dimension is 2-31/32 in. (75.4 mm).

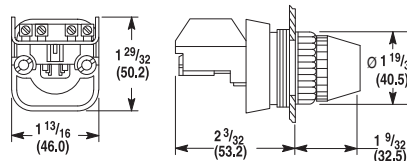


Dimensions in inches (millimeters). Dimensions are not intended to be used for manufacturing purposes.

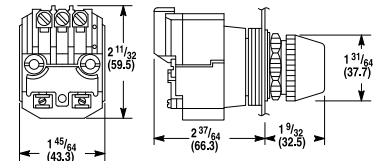
**Push-to-Test Pilot Light and Illuminated Devices (Bul. 800H Only)**



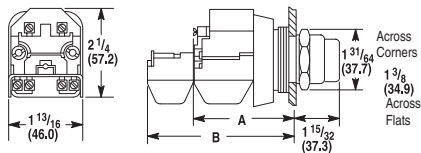
**Transformer Type Pilot Light**  
 (Incandescent and LED)  
**Shipping Weight. 12 oz (0.34 kg)**



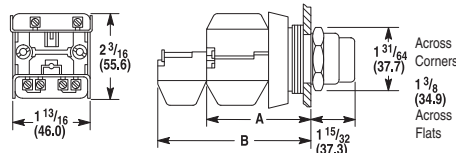
**Full Voltage and Dual Input Diode Type**  
 Pilot Light (Incandescent, Neon, LED)  
**Shipping Weight. 5 oz (0.14 kg)**



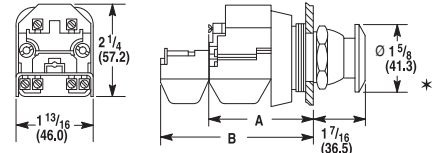
**Dual Input Transformer Type Pilot Light**  
**Shipping Weight. 14 oz (0.40 kg)**



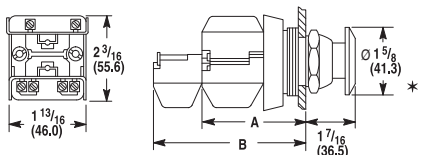
**Push-to-Test Pilot Light and Illuminated**  
 Push Button  
 (Transformer Type: Incandescent, LED)



**Push-to-Test Pilot Light and**  
 Illuminated Push Button  
 (Full Voltage: Incandescent, LED, Neon;  
 and Dual Input Type)



**Momentary Mushroom, Push-Pull and Twist or**  
 Pull Release Units  
 (Transformer Type: Incandescent, LED; Illuminated)



**Momentary Mushroom, Push-Pull and**  
 Twist or Pull Release Units  
 (Full Voltage: Incandescent, LED, Neon;  
 and Dual Input Illuminated)

**Push-to-Test Pilot Lights**  
**Illuminated Push Buttons, Illuminated Push-Pull and Twist or Pull Release Push Buttons**

Cat. No. Suffix*	Description	Transformer Type			Full Voltage or Neon Type		
			Dimension	Shipping Weight	Dimension	Shipping Weight	
D4	Transformer or Terminal Module and One Shallow Contact Block	A	2-5/32 (54.8)‡	9 oz. (0.25 kg)	A	2-1/32 (51.6)§	7 oz. (0.20kg)
A1 and A7	Transformer or Terminal Module, One Shallow Block and One Mini Contact Block	B	2-7/8 (73)	10 oz. (0.28 kg)	B	2-7/8 (73)	8 oz. (0.22 kg)
AP	Transformer or Terminal Module and One Sealed Switch Contact Block	B	2-29/32 (73.8)	10 oz. (0.28 kg)	B	2-29/32 (73.8)	8 oz. (0.22 kg)

\* Jumbo mushroom versions are 2-1/4 in. (57.2 mm) diameter.

⊛ Applies to illuminated push-pull push buttons only.

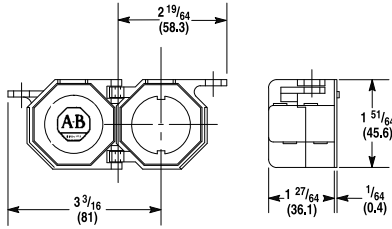
‡ Dual input type pilot light dimension is 2-13/32 in. (61.1 mm).

§ Dual input type pilot light dimension is 2-9/32 in. (57.9 mm).

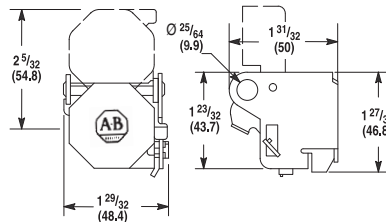
Bulletin 800T/H  
**30.5 mm Push Buttons**  
 Approximate Dimensions

Dimensions in inches (millimeters). Dimensions are not intended to be used for manufacturing purposes.

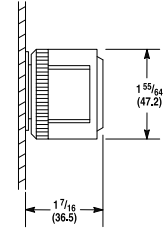
**Accessories**



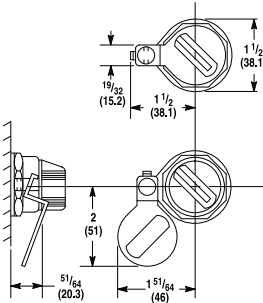
*Push Button Padlocking Cover*  
 (not for use with Jumbo Mushroom Head devices)  
**Shipping Wt. 1 oz (0.03 kg)**



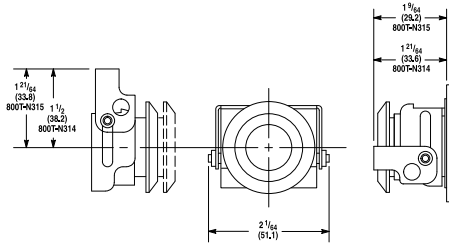
*Selector Switch and Potentiometer Unit Padlocking Cover*



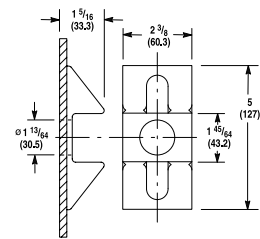
*Protective Ring and Push-Pull Illuminated or Non-Illuminated Operators*



*Selector Switch Padlocking Attachment*

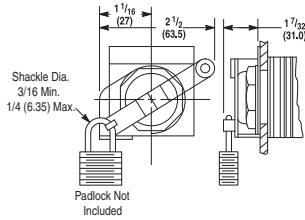


*Push-Pull Padlocking Attachment and Metal Mushroom Push Button Padlocking Attachment*

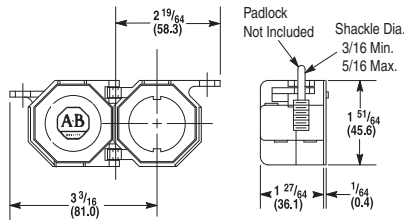


*Ramp Guard for Push-Pull Illuminated or Non-Illuminated Operators*

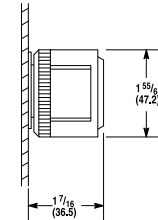
**Accessories (Bul. 800H Only)**



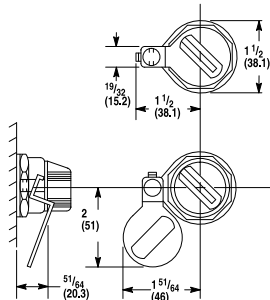
*Locking Attachment for Extended, Non-Illuminated Push Buttons*



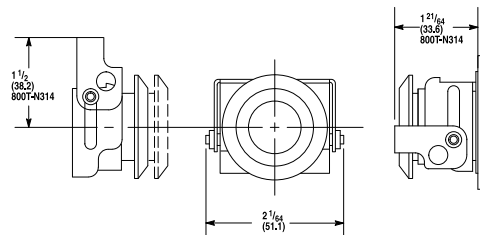
*800H-N140 Locking Cover for 2-Position Non-Illuminated Maintained Twist or Pull Release and Standard Knob Selector Switch (1-5/8 (41.3) Mushroom Head only)*



*Protective Ring for 2-Position Push-Pull/Twist Illuminated or Non-Illuminated Operators*



*Non-Illuminated Selector Switch Padlocking Adjustment*

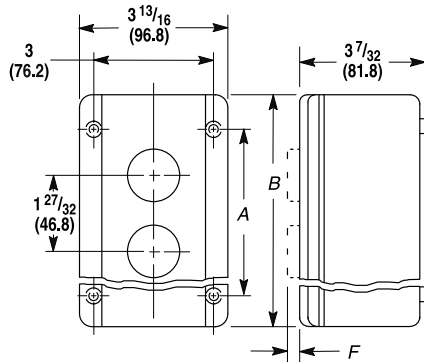


*Push-Pull/Twist Padlocking Attachment*



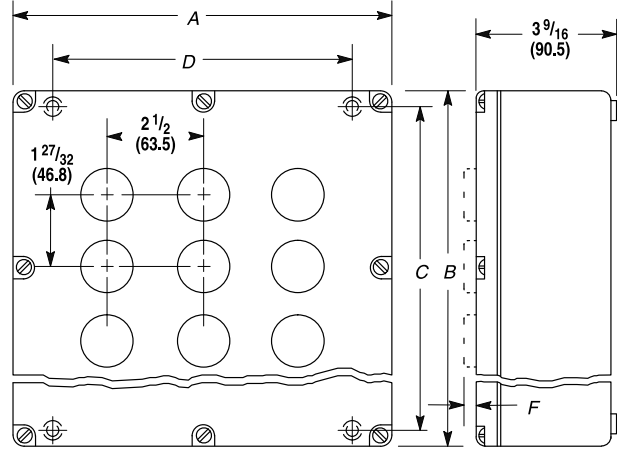
Dimensions in inches (millimeters). Dimensions are not intended to be used for manufacturing purposes.

**Die Cast Enclosures (Bul. 800T Only)**



Enclosure Dimensions					
Dim.	No. of Units				
	1	2	3	4	6
A	2-3/4 (69.9)	4-1/2 (114.3)	6-1/4 (158.8)	8 (203.2)	12-1/8 (308)
B	4-3/16 (106.4)	5-7/8 (144.2)	7-9/16 (192.1)	9-1/2 (241.3)	13-1/2 (342.4)

**Note:** Mounting holes (4) — Screw shaft 13/64 in. (5.16 mm) max. diameter.



Enclosure Dimensions				
Dim.	No. of Units			
	6	9	12	16
A	7-1/4 (184.2)	9-3/4 (247.7)	9-3/4 (247.7)	12-1/2 (317.5)
B	9 (228.6)	9 (228.6)	11 (279.4)	11 (279.4)
C	8-1/4 (209.6)	8-1/4 (209.6)	10-1/8 (257.2)	10-1/8 (257.2)
D	5-3/8 (136.5)	7-7/8 (200)	7-7/8 (200)	10-5/8 (269.9)

**Note:** Mounting holes (4) — Screw shaft 7/32 in. (5.56 mm) max. diameter.

**F Dimension**

Type of Unit		Dimension F
Push Buttons	Flush Extended	15/32 (11.9)
	Extended	21/32 (16.7)
	Mushroom	1 (25.4)
	Selector	7/8 (22.2)
	Cylinder Lock	1-13/16 (46)
Selector Switches	Standard	1-7/32 (30.9)
	Cylinder Lock	2-7/16 (61.9)
	Coin Slot	3/4 (19.1)
Pilot Light		1-1/8 (28.6)
Potentiometers		1-1/16 (27)

**Conduit Openings**

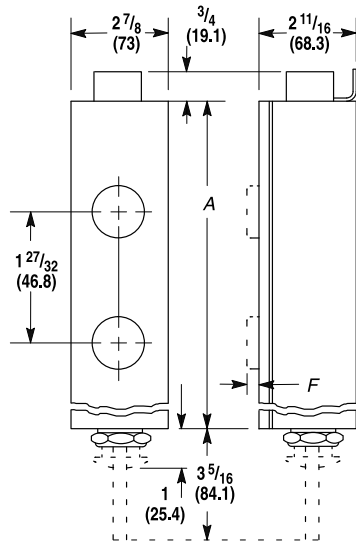
General Class	Description	No. of Units*						
		1...4	6	9	12	16	20	25
Surface Mounted Enclosure	Die Cast	3/4 in. 14 N.P.T.	1 in. 11-1/2 N.P.T.	1 in. 11-1/2 N.P.T.	1 in. 11-1/2 N.P.T.	1-1/2 in. 11-1/2 N.P.T.	—	—

\* Number of units that can be mounted in the enclosure.

Bulletin 800T/H  
**30.5 mm Push Buttons**  
 Approximate Dimensions

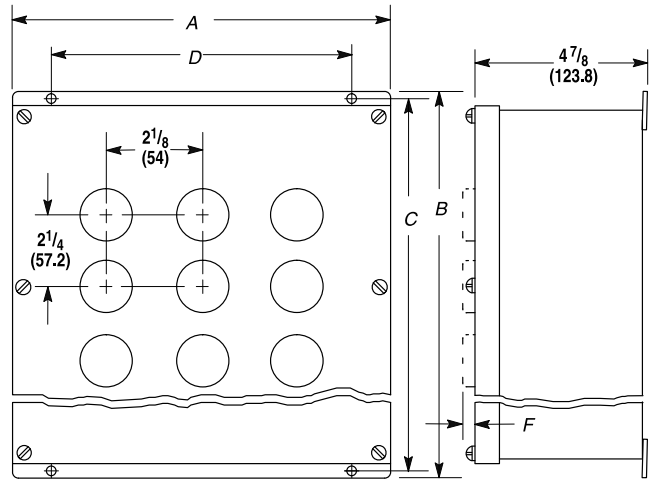
Dimensions in inches (millimeters). Dimensions are not intended to be used for manufacturing purposes.

**Enclosures (Bul. 800T Only), Continued**  
**Pendant Stations**



No. of Units	Dimension A
2	5-13/16 (147.6)
3	7-21/32 (194.5)
4	9-1/2 (241.3)
5	11-11/32 (288.1)
6	13-3/16 (335)
7	15-1/32 (381.7)
8	16-7/8 (428.6)
9	18-23/32 (475.4)
10	20-9/16 (522.3)

**Sheet Metal Enclosures**



Dim.	Enclosure Dimensions					
	No. of Units					
	6	9	12	16	20	25
A	6-15/16 (176.2)	8-11/16 (220.7)	8-11/16 (220.7)	10-7/16 (265.1)	10-7/16 (265.1)	12-1/2 (317.5)
B	11-1/8 (282.6)	11-1/8 (282.6)	13-1/2 (342.9)	13-1/2 (342.9)	15-7/8 (403.2)	15-7/8 (403.2)
C	10-1/2 (266.7)	10-1/2 (266.7)	12-7/8 (370)	12-7/8 (370)	15-1/4 (387.4)	15-1/4 (387.4)
D	5 (127)	6-3/4 (171.5)	6-3/4 (171.5)	8-1/2 (215.9)	8-1/2 (215.9)	10-1/4 (260.4)

**Note:** Mounting holes (4) — Screw shaft 7/32 in. (5.56 mm) max. diameter.

**F Dimension**

Type of Unit		Dimension F
Push Buttons	Flush Extended	15/32 (11.9)
	Extended	21/32 (16.7)
	Mushroom	1 (25.4)
	Selector	7/8 (22.2)
	Cylinder Lock	1-13/16 (46)
Selector Switches	Standard	1-7/32 (30.9)
	Cylinder Lock	2-7/16 (61.9)
	Coin Slot	3/4 (19.1)
Pilot Light		1-1/8 (28.6)
Potentiometers		1-1/16 (27)

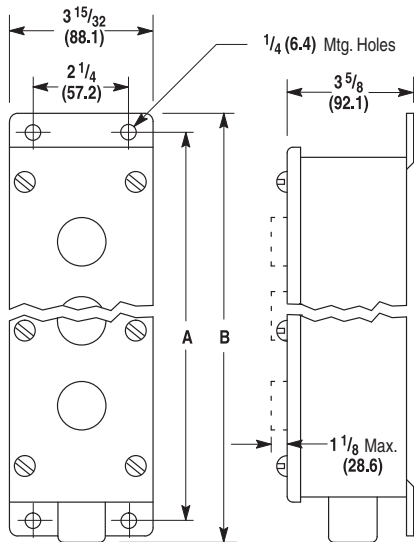
**10 Conduit Openings**

General Class	Description	No. of Units*					
		1...4	6	9	12	16	20
Surface Mounted Enclosure	Sheet Metal	None — Drilled to suit by customer.					
Pendant Type Enclosure	with Opening in Bottom	2...5			6...10		
		1 (25.4) Conduit Hub			1-1/4 (31.8) Conduit Hub		
	with Opening in Cover	1 (25.4) Conduit Hub			1-1/4 (31.8) Conduit Hub		

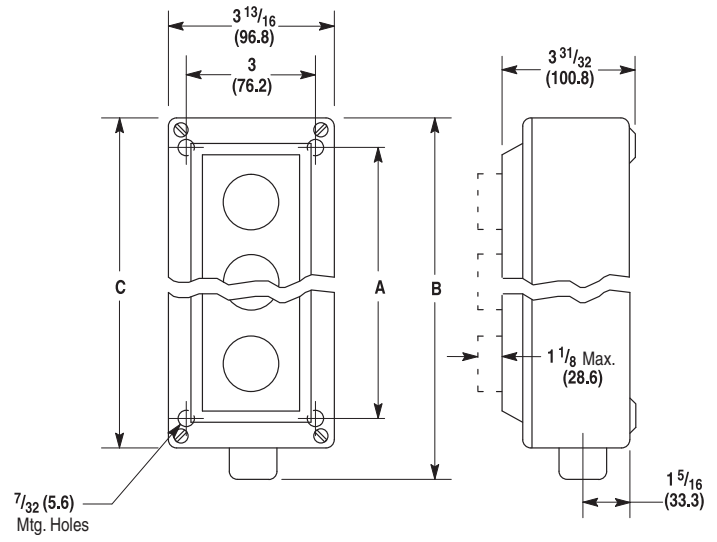
\* Number of units that can be mounted in the enclosure.

Dimensions in inches (millimeters). Dimensions are not intended to be used for manufacturing purposes.

**Enclosures (Bul. 800H Only)**



**Type 4/4X/13 Stainless Steel**  
 Watertight, Oiltight, Corrosion Resistant Enclosure



**Type 4/4X/13 Rosite Glass Polyester**  
 Watertight, Oiltight, Corrosion Resistant Enclosure

Dimension	Type 4/4X/13 Stainless Steel							
	Number of Units							
	1	2	3	4	5	6	7	8
A	5-5/32 (131)	7 (177.8)	8-27/32 (224.6)	10-11/16 (271.5)	12-17/32 (318.3)	14-3/8 (365.1)	16-7/32 (412)	18-1/16 (458.8)
B	6-13/32 (162.7)	8-1/4 (209.6)	10-1/8 (257.2)	11-31/32 (304)	14-1/32 (356.4)	15-7/8 (403.2)	17-3/4 (450.8)	19-19/32 (497.7)
C	—				—			
Conduit Knockout Size	—				—			
Pipe Tap Size	3/4 (19.1)				1 (25.4)			
Approximate Shipping Wt. [lbs (kg)]	2-3/4 (1.3)	3-3/4 (1.7)	4-3/4 (2.2)	5-3/4 (2.6)	6-3/4 (3.1)	7-3/4 (3.5)	8-3/4 (4)	9-3/4 (4.4)

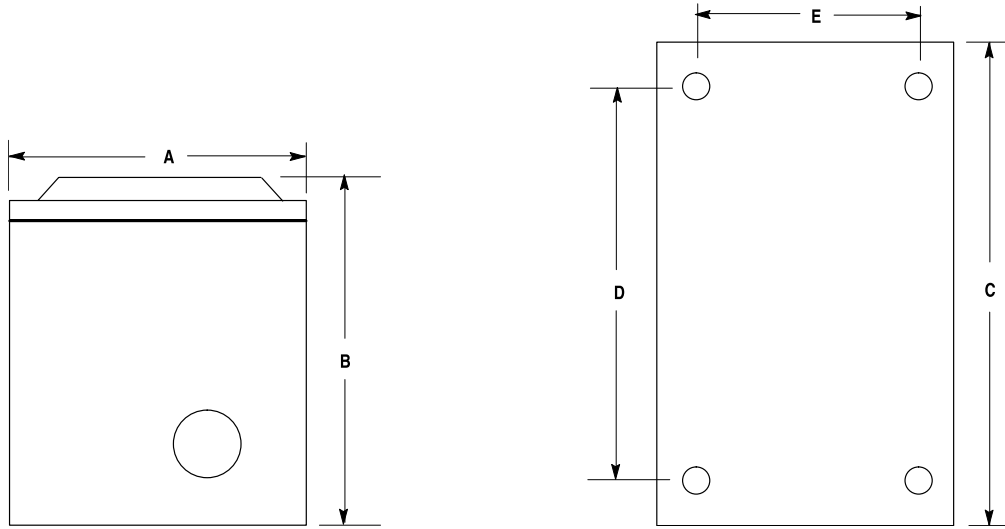
Dimension	Type 4/4X/13 Rosite					
	Number of Units					
	1	2	3	4	5	6
A	4-1/2 (114.3)	4-1/2 (114.3)	6-1/4 (158.8)	8 (203.2)	12-1/8 (308)	12-1/8 (308)
B	7-1/32 (178.6)	7-1/32 (178.6)	8-23/32 (221.5)	10-21/32 (270.7)	14-7/8 (377.8)	14-7/8 (377.8)
C	5-7/8 (149.2)	5-7/8 (149.2)	7-9/16 (192)	9-1/2 (241.8)	13-1/2 (342.9)	13-1/2 (342.9)
Conduit Knockout Size	—			—		
Pipe Tap Size	3/4 (19.1)			1 (25.4)		
Approximate Shipping Wt. [lbs (kg)]	2 (0.9)	2 (0.9)	2-1/2 (1.1)	3 (1.4)	4 (1.8)	4 (1.8)

# 30.5 mm Push Buttons

## Approximate Dimensions

Dimensions in inches (millimeters). Dimensions are not intended to be used for manufacturing purposes.

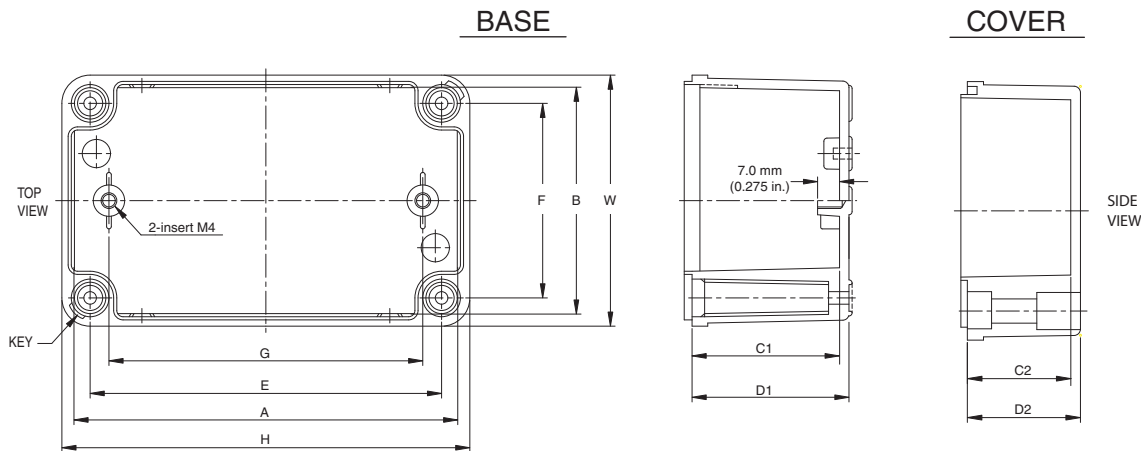
Enclosures (Bul. 800H Only), Continued



Dimension	Fiberglass Type 4/4X/12/13		
	Number of Units		
	1	2	3
A x B x C	4-1/2 x 5-3/16 x 6 (114.3 x 131.8 x 152.4)	4-1/2 x 5-3/16 x 8 (114.3 x 131.8 x 203.2)	6-1/2 x 5-7/16 x 8 (165.1 x 138.1 x 203.2)
D x E	4-3/4 x 2 (120.7 x 50.8)	6-3/4 x 2 (171.5 x 50.8)	6-3/4 x 4 (171.5 x 101.6)
Conduit Knockout Size	3/4 (19.1)	1 (25.4)	1 (25.4)
Approximate Shipping Wt. [lb (kg)]	2 (0.9)	1/4 (1.0)	3 (1.4)

Dimensions are shown in millimeters (inches). Dimensions are not intended to be used for manufacturing purposes.

**Enclosures (Bul. 800H Only), Continued**

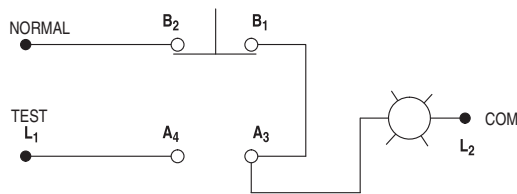


Thermoplastic Polyester Type 4/4X

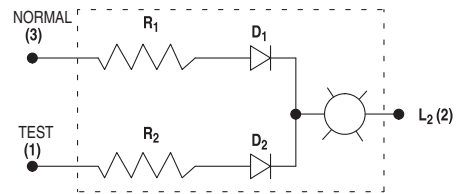
Cat. No.	Overall Dimension				Inside Dimension				Enclosure Mounting Dimension		Mounting Plate Mounting Dim.
	H	W	D1	D2	A	B	C1	C2	E	F	
800H-1HZ4	110 (4.33)	80 (3.15)	50 (1.97)	20 (0.79)	104 (4.09)	74 (2.91)	46.5 (1.83)	16.5 (0.65)	92 (3.62)	62 (2.44)	80 (3.15)
800H-2HZ4	130 (5.12)	80 (3.15)	50 (1.97)	35 (1.38)	120 (4.72)	70 (2.76)	46.5 (1.83)	31.5 (1.24)	112 (4.41)	62 (2.44)	100 (3.94)
800H-3HZ4	180 (7.09)	80 (3.15)	50 (1.97)	35 (1.38)	170 (6.69)	70 (2.76)	46.5 (1.83)	31.5 (1.24)	162 (6.38)	62 (2.44)	150 (5.91)
800H-4HZ4	250 (9.84)	80 (3.15)	50 (1.97)	35 (1.38)	240 (9.45)	70 (2.76)	46.5 (1.83)	31.5 (1.24)	232 (9.13)	62 (2.44)	220 (8.66)

**Typical Pilot Light Wiring Diagrams**

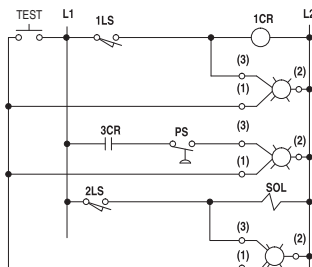
See applicable codes and laws



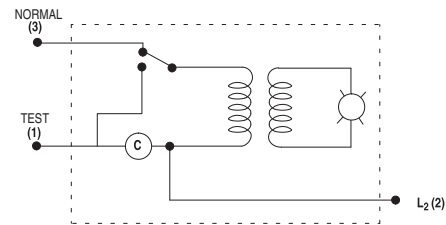
**Push-to-Test Pilot Light Device Schematic**



**Dual Input Diode Pilot Light Device Schematic**



**Dual Input Pilot Light Typical Application Wiring Diagram**



**Dual Input Pilot Light Transformer Type Device Schematic**

# 22.5 mm Push Buttons

## Product Overview



### Bulletin 800F Plastic and Metal Operators

- 22.5 mm mounting hole
- IP65/66, Type 4/4X/13
- Internationally rated operators

### Table of Contents

See below.

## TABLE OF CONTENTS

Description	Page
<b>Specifications</b> .....	10-67
<b>Quick Selection</b> .....	10-70
<b>Push Buttons, Momentary</b>	
Non-Illuminated — Flush, Extended, Guarded.....	10-73
Non-Illuminated — with Two-Color Molded Legend Caps....	10-74
Illuminated — Flush, Extended, Guarded.....	10-75
<b>Push Buttons, Alternate Action</b>	
Non-Illuminated — Flush.....	10-76
Illuminated — Flush.....	10-76
<b>Pilot Light Operators</b> .....	10-77
<b>Selector Switches</b>	
Non-Illuminated, 2-Position.....	10-78
Illuminated, 2-Position.....	10-79
Non-Illuminated, 3-Position.....	10-80
Illuminated, 3-Position.....	10-81
Non-Illuminated, 4-Position.....	10-82
<b>Key Selector Switches</b>	
2-Position .....	10-83
3-Position .....	10-84
<b>Emergency Stop Operators</b>	
Twist-to-Release and Push-Pull Mushroom Operators	
Non-Illuminated .....	10-85
Illuminated .....	10-85
Key Release Mushroom Operators .....	10-85
Push-Pull Mushroom Operator, 3-Position .....	10-89
<b>Momentary Mushroom Operators</b>	
Non-Illuminated.....	10-90
Illuminated.....	10-91

Description	Page
<b>Multi-Function Operators</b>	
2-Function, Momentary, Non-Illuminated .....	10-92
2-Function, Momentary, Illuminated .....	10-93
3-Function, Momentary, Non-Illuminated .....	10-94
<b>Reset Operators</b> .....	10-95
<b>Single-Turn Potentiometer Assembly</b>	10-96
<b>Key Operated Selector Switch — SensEject™</b> .....	10-96
<b>Selector Push Button Operators</b> .....	10-97
<b>Toggle Switch Operators</b> .....	10-98
<b>Back-of-Panel Components</b>	
Contact Blocks.....	10-99
Power Modules .....	10-99
Power Modules with Contact Blocks.....	10-100
<b>Enclosures</b> .....	10-103
<b>Assembled Stations</b> .....	10-103
<b>Assembled Stations with DeviceNet</b> .....	10-105
<b>Pendant Stations</b> .....	10-106
<b>Accessories</b>	
Miscellaneous .....	10-107
Guards .....	10-109
Locking Attachments.....	10-110
Replacement Lamps .....	10-111
Color Caps, Lenses, Diffusers without Text .....	10-112
Two-Color Molded Legend Caps.....	10-113
E-Stop Legends.....	10-113
Legend Plates.....	10-114
Custom Laser-Engraved Caps/Diffusers.....	10-115
Legend Text.....	10-116
<b>Approximate Dimensions</b> .....	10-120

### Bulletin 800FP Plastic Operators

- IP65/66, Type 4/4X/13
- Engineering grade thermoplastics
- Chemical-resistant for harsh environments



**Bul. 800FP Plastic Operators**

### Bulletin 800FM Metal Operators

- IP65/66, Type 4/13
- Die-cast metal construction
- Chrome-plated



**Bul. 800FM Die-Cast Metal Operators**





**Overview, Continued**

**3-Across x 2-Deep Back-of-Panel (6 Circuits Max.)**

- Rugged snap-fit design for plastic or metal latch
- Stackable contact blocks
- Rotating collar for easy one-hand latch removal
- Color-coded contact block plungers for contact identification

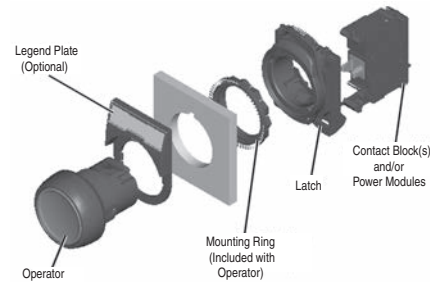


**Plastic Latch with Contact Block**



**Metal Latch with Contact Block**

**Assembly Overview**



**Specifications\***

**Front-of-Panel (Operators)**

Description		Mechanical Ratings	
		Plastic (Bulletin 800FP)	Metal (Bulletin 800FM)
Vibration (assembled to panel)		Tested at 10...2000 Hz, 1.52 mm displacement (peak-to-peak) max./10 G max. for 3 hr duration, no damage	
Shock		Tested at 1/2 cycle sine wave for 11 ms; no damage at 100 G	
Degree of protection*		IP65/66 (Type 3/3R/4/4X/12/13)	IP65/66 (Type 3/3R/4/12/13)
Mechanical durability per EN 60947-5-1 (Annex C)	10 000 000 Cycles	Momentary push buttons, momentary mushroom	
	1 000 000 Cycles	Multi-function, selector switch, key selector switch, selector jog, SensEject™ key selector switch	
	500 000 Cycles	Non-illuminated push-pull E-stop‡	
	300 000 Cycles	Twist-to-release E-stop, illuminated push-pull E-stop‡, alternate action push buttons	
	100 000 Cycles	Potentiometer, toggle switch	
Operating forces (typical with one contact block)		Flush/extended = 5 N, E-stop = 36 N Mushroom = 9 N	
Operating torque (typical application with one contact block)		Selector switch = 0.25 N•m (2.2 lb•in)	
Mounting torque	Plastic	1.7 N•m (15 lb•in)	
	Metal	4.4 N•m (40 lb•in)	
Environmental			
Temperature range (operating)		-25...+70 °C (-13...+158 °F)§	
Temperature range (short term storage)		-40...+85 °C (-40...+185 °F)	
Humidity		50...95% RH from 25...60 °C (77...140 °F)	

\* Performance Data — see page Important-3 of the Industrial Controls catalog.

⊛ Momentary mushroom operators are IP65. Plastic keyed operators are IP66, Type 4/13; not Type 4X.

‡ Limit of four contact blocks max. for these devices.

§ Operating temperatures below 0 °C (32 °F) are based on the absence of freezing moisture and liquids, UL Recognized to 55 °C (131 °F) - Incandescent module max. 40 °C (104 °F).

**Product Certifications**

Certifications	UR/UL, CSA, CCC, CE
Standards Compliance — CE Marked	NEMA ICS-5; UL 508, EN ISO 13850, EN 60947-1, EN 60947-5-1, EN 60947-5-5
Terminal Identification	EN/IEC 60947-1
Shipping Approvals	ABS
RoHS	✓

**Bulletin 800F**  
**22.5 mm Push Buttons**  
**Specifications**

**Back-of-Panel Components\***

Electrical Ratings			
Standard contact block ratings	A600, Q600 600V AC AC 15, DC 13 to IEC/EN 60947-5-1 and UL 508, 17V, 5 mA min.		
Low voltage contact block ratings*	5V, 1 mA DC min. C300, R150, AC 15, DC 13 to EN 60947-5-1 and UL 508		
	<b>Nominal Voltage</b>	<b>Range</b>	<b>Current Draw</b>
LED Module Ratings	24...120V AC/DC	20...132V AC/DC	15 mA (AC), 12 mA (DC)
	24V AC	10...29V AC	31 mA
	24V DC	10...30V DC	24 mA
	120V AC	102...132V AC	6 mA
	240V AC	204...264V AC	6 mA
Frequency	50/60 Hz, DC		
Thermal current	10 A max. enclosed (40 °C ambient) to UL508, EN 60947-5-1		
Insulation voltage (U <sub>i</sub> )	Screw terminal = 690V, spring-clamp = 300V		
Wire capacity (screw terminal)‡	#18...12 AWG (0.75...2.5 mm <sup>2</sup> ) Max. (2) #14 AWG or (1) #12 AWG		
Wire capacity (spring-clamp terminal)	#18...14 AWG (0.75...1.5 mm <sup>2</sup> ) One per spring clamp, two spring clamps per terminal		
Recommended tightening torque on screw terminals	0.7...0.9 N•m (6...8 lb•in)		
Dielectric strength (minimum)	2500V for one minute		
External short circuit protection	Standard blocks	10 A type gL/gG cartridge fuse to EN 60269-2-1 or gN (Class J to UL 248-8 or Class C to UL 248-4)	
	Low voltage contact blocks	6 A type gL/gG cartridge fuse to EN 60269-2-1 or gN (Class J to UL 248-8 or Class C to UL 248-4)	
Electrical shock protection	Finger-safe conforming to IP2X		
Mechanical Ratings			
Vibration (assembled to panel)	Tested at 10...2000 Hz, 1.52 mm displacement (peak-to-peak) max./10 G max. 6 hr		
Shock	Tested at 1/2 cycle sine wave for 11 ms and no damage at 100 G max.		
Contact durability per EN 60947-5-1 (Annex C)	10 000 000 cycles		
Contact operation	N.O.	Slow double make and break	
	N.C. & S.M.C.B.	Slow double make and break — positive opening ⊖	
	N.O.E.M.	Double break / double make, early make	
	N.C.L.B.	Double break / double make, late break — positive opening ⊖	
	N.C.E.B.	Double break / double make, early break — positive opening ⊖	
Push button travel to change electrical state	N.C. and N.O.E.M.	1.5 mm (0.060 in.)	
	N.O. and N.C.L.B.	2.5 mm (0.1 in.)	
Operating forces (typical)	Single circuit contact block	3.4 N	
	Dual circuit contact block	5...6.5 N	
Illumination			
LED Dominant Wavelength	Green	525 nm	
	Red	629 nm	
	Yellow	590 nm	
	Blue	470 nm	
	White	—	
LED Luminous Intensity	Green	780 mcd	
	Red	780 mcd	
	Yellow	600 mcd	
	Blue	168 mcd	
	White	360 mcd	
Incandescent maximum wattage	2.6 W		
Materials			
Springs	Stainless steel and zinc coated music wire		
Electrical contacts	Standard	Silver-nickel	
	Low voltage	Gold-plated over silver	
Terminals	Screw	Brass	
	Spring-clamp	Silver-plated brass	

\* Performance Data — see page Important-3 of the Industrial Controls catalog.

\* Low voltage contacts are recommended for applications below 17V, 5 mA.

‡ Wires less than #18 AWG (0.75 mm<sup>2</sup>) may not hold in terminal securely.



**Material Listing**

Component	For Use with	Material Used
Panel gasket	All operators	Nitrile, TPE
Diaphragm seal	Illuminated push button, non-illuminated push button	Automotive industry acceptable silicone
K-seal	Selector switch, key selector switch, push/twist-to-release E-stop, key E-stop, push/pull mushroom	Nitrile
Diaphragm retainer, return spring I	Illuminated push button, non-illuminated push button, momentary mushroom	Stainless steel
Return spring II	Reset, selector switch, key selector switch, alternate action, push/twist-to-release E-stop, key E-stop, push/pull mushroom	Zinc-coated music wire
Button cap/mushroom head	Non-illuminated push button, momentary mushroom, reset, push/twist-to-release E-stop, key E-stop, push/pull mushroom, multi-function	PBT/polycarbonate blend
2-color molded button cap	Non-illuminated push button	PBT/polycarbonate blend
Lens	Multi-function	Acetal
Lens, knob	Illuminated push button, illuminated momentary mushroom, illuminated selector switch	Polyamide
Knob	Non-illuminated selector switch	Glass-filled polyamide
Plastic bezel/bushing I	Non-illuminated push button, illuminated push button, momentary mushroom, selector switch, key selector switch, push/twist-to-release E-stop, key E-stop, push/pull mushroom, multi-function, reset	Glass-filled polyamide
Plastic bezel/bushing II, jam nut	Pilot light, reset jam nut, reset pushers	Glass-filled PBT
Metal bezel/bushing	All metal operators	Zinc
Diffuser	Illuminated push button, pilot light	Polycarbonate
Legend frames	—	Glass-filled polyamide
Plastic mounting ring	All plastic operators	Glass-filled polyamide
Metal mounting ring	All metal operators	Chromated zinc
Plastic latch	—	Glass-filled polyamide
Metal latch	—	Chromated zinc + stainless steel
Plastic enclosure	—	PBT/polycarbonate blend
Metal enclosure	—	Aluminum
Terminal screws	LED module, incandescent module, contact blocks	Zinc-plated steel with chromate
Terminals	LED module, incandescent module, contact blocks	Brass with silver-nickel contacts
Spring clamps	LED module, incandescent module, contact blocks	Stainless steel
Lamp socket	Incandescent module	Brass
Housing	Incandescent module, LED module	Glass-filled polyamide
Low-voltage terminals	Contact blocks	Gold-plated silver-nickel contacts
Low-voltage spanner	Contact blocks	Gold-plated silver-nickel contacts
Spanner	Contact blocks	Brass with silver-nickel contacts
Boot	Toggle Switch, illuminated push button, non-illuminated push button, multi-function illuminated and non-illuminated	Automotive industry acceptable silicone

## 22.5 mm Push Buttons

## Quick Selection




Quick Selection  
Components

Operator Style	Description	Color	Construction	Pkg. Quantity	Cat. No.
 <p>Flush Operator Cat. No. 800FP-F3</p>	Non-illuminated, flush push button	Black	Plastic	1	800FP-F2
	Non-illuminated, flush push button	Green			800FP-F3
	Non-illuminated, extended push button	Red			800FP-E4
	Non-illuminated, flush push button	Black	Metal		800FM-F2
	Non-illuminated, flush push button	Green			800FM-F3
	Non-illuminated, extended push button	Red			800FM-E4
 <p>Flush Operator Cat. No. 800FM-LF4</p>	Illuminated, flush push button	Green	Plastic	1	800FP-LF3
	Illuminated, extended push button	Red			800FP-LE4
	Illuminated, flush push button	Yellow			800FP-LF5
	Illuminated, flush push button	Green	Metal		800FM-LF3
	Illuminated, extended push button	Red			800FM-LE4
	Illuminated, flush push button	Yellow			800FM-LF5
 <p>Diffused Pilot Light Cat. No. 800FP-P7</p>	Diffused pilot light	Green	Plastic	1	800FP-P3
		Red			800FP-P4
		Yellow			800FP-P5
		Green	Metal		800FM-P3
		Red			800FM-P4
Yellow	800FM-P5				
 <p>Selector Switch Cat. No. 800FP-SM32</p>	Non-illuminated, 2-position, maintained selector switch	Black	Plastic	1	800FP-SM22
	Non-illuminated, 3-position, maintained selector switch				800FP-SM32
	Non-illuminated, 3-position, spring return from both positions selector switch				800FP-SB32
	Non-illuminated, 2-position, maintained selector switch		Metal		800FM-SM22
	Non-illuminated, 3-position, maintained selector switch				800FM-SM32
	Non-illuminated, 3-position, spring return from both positions selector switch				800FM-SB32
 <p>40 mm Trigger Action Twist-to-Release Mushroom Cat. No. 800FP-MT44</p>	Non-illuminated, 40 mm twist-to-release maintained mushroom (plastic)	Red	Plastic	1	800FP-MT44
	Non-illuminated, 40 mm push-pull maintained mushroom				800FP-MP44
	Non-illuminated, 40 mm twist-to-release maintained mushroom (metal)		Metal		800FM-MT44
	Non-illuminated, 40 mm push-pull maintained mushroom				800FM-MP44
Back of Panel	Description			Pkg. Quantity	Cat. No.
 <p>Power Module with Latch Cat. No. 800F-MN3G</p>	Metal latch			10	800F-ALM
	Plastic latch				800F-ALP
	Normally open contact block				800F-X10
	Normally closed contact block				800F-X01
	Integrated LED module with plastic latch — Red LED			1	* 800F-PNxR
	Integrated LED module with plastic latch — Green LED				* 800F-PNxG
	Integrated LED module with plastic latch — White LED				* 800F-PNxW
	Integrated LED module with metal latch — Red LED				* 800F-MNxR
	Integrated LED module with metal latch — Green LED				* 800F-MNxG
	Integrated LED module with metal latch — White LED				* 800F-MNxW


\* To complete the cat. no., replace the x with one of the following voltage codes: 3 = 24V, 5 = 120V, 7 = 240V.

**Complete Devices\***

**Non-Illuminated Push Buttons, Momentary (Screw Terminal Connections)**

	Description	Type of Contact		Color	Construction	Pkg. Quantity	Cat. No.
		N.O.	N.C.				
 Cat. No. 800FP-F3PX10	Flush	1	—	Green	Plastic operator/plastic latch	1	800FP-F3PX10
				Black			800FP-F2PX10
				Green	Metal operator/metal latch		800FM-F3MX10
				Black			800FM-F2MX10
 Cat. No. 800FM-E4MX01	Extended	—	1	Red	Plastic operator/plastic latch	1	800FP-E4PX01
					Metal operator/metal latch		800FM-E4MX01
 Cat. No. 800FP-U2E4F3PX10	Multi-function (Flush/extended)	1	1	Green/Red	Plastic operator/plastic latch	1	800FP-U2E4F3PX11
					Metal operator/metal latch		800FM-U2E4F3MX11
				Green "1" / Red "0"	Plastic operator/plastic latch		800FP-U2EFFEPX11
					Metal operator/metal latch		800FM-U2EFFEMX11

**Non-Illuminated Selector Switches (Screw Terminal Connections)**

	Description	Type of Contact		Style	Construction	Pkg. Quantity	Cat. No.		
		N.O.	N.C.						
 Cat. No. 800FP-SM22PX10	Standard lever, black	1	—	2-position maintained	Plastic operator/plastic latch	1	800FP-SM22PX10		
				1	1		2-position maintained	Plastic operator/plastic latch	800FP-SM22PX11
				1	—		2-position maintained	Metal operator/metal latch	800FM-SM22MX10
				1	1		2-position maintained	Metal operator/metal latch	800FM-SM22MX11
				2	—		3-position maintained	Plastic operator/plastic latch	800FP-SM32PX20
				2	—		3-position maintained	Metal operator/metal latch	800FM-SM32MX20

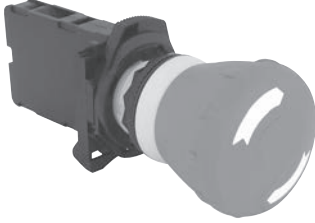
\* For complete devices not listed and configuration assistance, see RAISE product selection software (<http://www.ab.com/raise>).

## 22.5 mm Push Buttons

### Quick Selection


#### Complete Devices, Continued\*

#### Non-Illuminated Emergency Stop Operators, Ø 40 mm, Red (Screw Terminal Connections)

	Description	Type of Contact*		Construction	Pkg. Quantity	Cat. No.
		N.O.	N.C.			
 <p><i>Cat. No. 800FP-MT44PX01S</i></p>	Twist-to-Release	—	1	Plastic operator/plastic latch	1	<b>800FP-MT44PX01S</b>
		—	1	Metal operator/metal latch		<b>800FM-MT44MX01S</b>
		1	1	Plastic operator/plastic latch		<b>800FP-MT44PX11S</b>
		1	1	Metal operator/metal latch		<b>800FM-MT44MX11S</b>

\* Self-monitoring contact block included when N.C. is specified.

#### Pilot Lights with Integrated LED Modules (Screw Terminal Connections)

	Voltage	Style	Construction	Pkg. Quantity	Cat. No.
 <p><i>Cat. No. 800FP-P7PN3W</i></p>	24V AC/DC	Green	Plastic operator/plastic latch	1	<b>800FP-P3PN3G</b>
		Red			<b>800FP-P4PN3R</b>
		Yellow			<b>800FP-P5PN3Y</b>
		Blue			<b>800FP-P6PN3B</b>
		White			<b>800FP-P7PN3W</b>
	120V AC	Green			<b>800FP-P3PN5G</b>
		Red			<b>800FP-P4PN5R</b>
		Yellow			<b>800FP-P5PN5Y</b>
		Blue			<b>800FP-P6PN5B</b>
		White			<b>800FP-P7PN5W</b>
	240V AC	Green			<b>800FP-P3PN7G</b>
		Red			<b>800FP-P4PN7R</b>
		Yellow			<b>800FP-P5PN7Y</b>
		Blue			<b>800FP-P6PN7B</b>
		White			<b>800FP-P7PN7W</b>

\* For complete devices not listed and configuration assistance, see RAISE product selection software (<http://www.ab.com/raise>).



Momentary Push Button Operators, Non-Illuminated — Flush, Extended, Guarded



Flush Operator  
 Cat. No. 800FP-F3



Extended Operator  
 Cat. No. 800FM-E4



Guarded Operator  
 Cat. No. 800FP-G6

Color	Pkg. Quantity	Flush		Extended	
		Plastic	Metal	Plastic	Metal
		Cat. No.	Cat. No.	Cat. No.	Cat. No.
Black	1	800FP-F2	800FM-F2	800FP-E2	800FM-E2
Green		800FP-F3	800FM-F3	800FP-E3	800FM-E3
Red		800FP-F4	800FM-F4	800FP-E4	800FM-E4

800F  P  -  F   3  -    
           a      b      c      d

**a**

Operator Construction	
Code	Description
P	Round plastic operator (IP66, Type 4/4X/13)
M	Round metal operator (IP66, Type 4/13)

**c**

Color Cap	
Code	Color
0	Orange
1	White
2	Black
3	Green
4	Red
5	Yellow
6	Blue
8	Grey*
9	No cap
X	Assortment pack*

**d**

Packaging	
Code	Description
Blank	1 per package
BP	10 per package‡

**b**

Operator Type	
Code	Description
F	Flush
E	Extended
G	Guarded

\* Available in flush only.  
 \* Assortment pack contains one cap of each color, not available in BP packaging.  
 ‡ Only available with no color cap (9 from Table c).



Momentary Push Button Operators, Illuminated — Flush, Extended, Guarded



Flush Operator  
 Cat. No. 800FM-LF4



Extended Operator  
 Cat. No. 800FP-LE3



Guarded Operator  
 Cat. No. 800FP-LG3

Color	Pkg. Quantity	Flush		Extended	
		Plastic	Metal	Plastic	Metal
		Cat. No.	Cat. No.	Cat. No.	Cat. No.
Green	1	800FP-LF3	800FM-LF3	800FP-LE3	800FM-LE3
Red		800FP-LF4	800FM-LF4	800FP-LE4	800FM-LE4
Yellow		800FP-LF5	800FM-LF5	800FP-LE5	800FM-LE5
Clear		800FP-LF7	800FM-LF7	800FP-LE7	800FM-LE7

800F  P  -  LE   3  -    
           a                  b                  c                  d

**a**

Operator Construction	
Code	Description
P	Round plastic operator (IP66, Type 4/4X/13)
M	Round metal operator (IP66, Type 4/13)

**c**

Color Cap *	
Code	Color
0	Amber*
3	Green
4	Red
5	Yellow*
6	Blue*
7	Clear
9	No cap

**d**

Packaging	
Code	Description
Blank	1 per package
BP	10 per package†

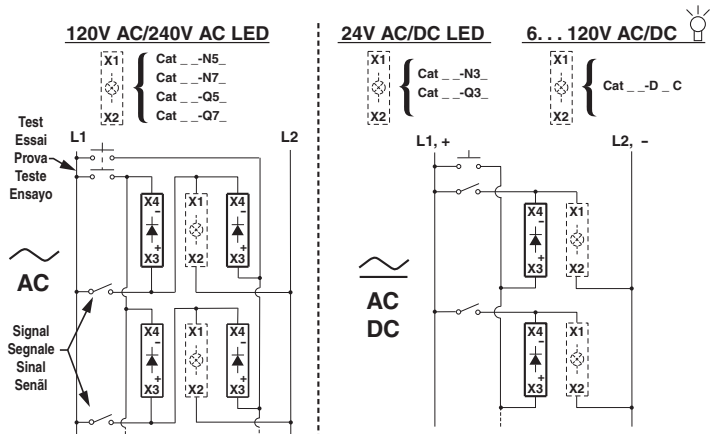
**b**

Operator Type	
Code	Description
LF	Flush
LE	Extended
LG	Guarded

\* For custom laser-engraved operator, order operator with applicable lens cap color plus custom laser-engraved diffuser; see page 10-115.  
 \* When using LED for illumination, a white LED is recommended.  
 † Only available with no color cap (9 from Table c).

**Push-to-Test Push Button Device Schematic**

Illuminated push buttons may be wired as a push-to-test device by using the following schematic and Cat. No. 800F-XD7 Diode module from page 10-111.



# 22.5 mm Push Buttons

## Product Selection

### Alternate Action Operators — Non-Illuminated



Cat. No. 800FM-FA3

800F  M  -  FA   3   
           a          b          c

a

Operator Construction	
Code	Description
P	Round plastic operator (IP66, Type 4/4X/13)
M	Round metal operator (IP66, Type 4/13)

b

Operator Type*	
Code	Description
FA	Non-illuminated, flush, alternate action

c

Color Cap*	
Code	Color
0	Orange
1	White
2	Black
3	Green
4	Red
5	Yellow
6	Blue
9	No cap
X	Assortment pack

\* Must use N.O.E.M. or N.C. contacts.

⚙ For custom laser-engraved legend cap, order "no cap" option plus custom laser-engraved cap on page 10-115.

### Alternate Action Operators — Illuminated



Cat. No. 800FP-LFA3

800F  P  -  LFA   3   
           a          b          c

a

Operator Construction	
Code	Description
P	Round plastic operator (IP66, Type 4/4X/13)
M	Round metal operator (IP66, Type 4/13)

b

Operator Type§*	
Code	Description
LFA	Illuminated, flush, alternate action

c

Color Cap>	
Code	Color
0	Amber⚙
3	Green
4	Red
5	Yellow⚙
6	Blue⚙
7	Clear
9	No lens

§ Must use N.O.E.M. or N.C. contacts.

⚙ LED module required for illumination, can not use incandescent module.

> For custom laser-engraved operator, order operator with applicable lens cap color plus custom laser-engraved diffuser on page 10-115.

⚙ Use of a white LED is recommended.

Pilot Light Operators\*



Plastic Pilot Light  
 Cat. No. 800FP-P7



Metal Pilot Light  
 Cat. No. 800FM-P4

Color	Pkg. Quantity	Plastic	Metal
		Cat. No.	Cat. No.
Green	1	800FP-P3	800FM-P3
Red		800FP-P4	800FM-P4
Yellow		800FP-P5	800FM-P5

800F  P  -  P   3  -    
           a      b      c      d

**a**

Operator Construction	
Code	Description
P	Round plastic operator (IP66, Type 4/4X/13)
M	Round metal operator (IP66, Type 4/13)

**c**

Lens Cap*	
Code	Color
0	Amber*
3	Green
4	Red
5	Yellow*
6	Blue*
7	Clear
9	No lens

**d**

Packaging	
Code	Description
Blank	1 per package
BP	10 per package

**b**

Operator Type	
Code	Description
P	Diffuser

\* For custom laser-engraved pilot light, order pilot light with applicable lens cap color plus custom laser-engraved diffuser on page 10-115.  
 \* When using LED for illumination, a white LED is recommended.

Bulletin 800F  
**22.5 mm Push Buttons**  
 Product Selection

2-Position Selector Switch Operators, Non-Illuminated

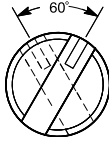


Standard Knob  
 Cat. No. 800FP-SM22



Knob Lever  
 Cat. No. 800FP-HM22

Switching Angle



Target Table and Operator Position*		
Contact Type§		
N.O.	O	X
N.C.	X	O

Note: X = Closed/O = Open

§ Contact selection is limited to the following options, consult your local Rockwell Automation sales office or Allen-Bradley distributor for other options.

Color	Operator Type		Pkg. Quantity	Standard Knob	
				Plastic	Metal
				Cat. No.	Cat. No.
Black with White Insert			1	800FP-SM22	800FM-SM22

\* Target table for spring return from left is reversed from what is shown in the table.

**800F**   **P** - **S**   **M2**   **2**   -   **e** - **f**  
*a*   *b*   *c*   *d*   *e*   *f*

**a**

Operator Construction	
Code	Description
P	Round plastic operator (IP66, Type 4/4X/13)
M	Round metal operator (IP66, Type 4/13)

**b**

Operator Type	
Code	Description
S	Standard knob
H	Knob lever*

**c**

Operator Function	
Code	Type
M2	Maintained (60° switching angle) 
L2	Spring return from left (60° switching angle) 
R2	Spring return from right (60° switching angle) 

**d**

Knob/Insert Color		
Code	Knob Color	Insert Color
2	Black	White

**e**

Orientation	
Code	Description
Blank	Standard
N	90° offset†

**f**

Packaging	
Code	Description
Blank	1 per package
BP	10 per package‡

\* 30 mm hole spacing will not work if knob lever is used. See page 10-125 for recommended operator panel spacing.  
 † For use in vertical mount Bul. 800F enclosures.  
 ‡ Not available with 90° offset orientation.



2-Position Selector Switch Operators, Illuminated §



**Standard Knob**  
 Cat. No. 800FP-LSM26

Switching Angle



Target Table and Operator Position*		
Contact Type➤		
N.O.	O	X
N.C.	X	O

Note: X = Closed/O = Open

➤ Contact selection is limited to the following options, consult your local Rockwell Automation sales office or Allen-Bradley distributor for other options.

Color	Operator Type		Pkg. Quantity	Standard Knob	
				Plastic	Metal
				Cat. No.	Cat. No.
Green	∨		1	800FP-LSM23	800FM-LSM23
Red	∨			800FP-LSM24	800FM-LSM24
Yellow	∨			800FP-LSM25	800FM-LSM25

\* Target table for spring return from left is reversed from what is shown in the table.

**800F**   **P** - **LS**   **M2**   **3**   \_\_\_\_\_  
                   **a**            **b**            **c**            **d**            **e**

**a**

Operator Construction	
Code	Description*
P	Round plastic operator (IP66, Type 4/4X/13)
M	Round metal operator (IP66, Type 4/13)

**b**

Operator Type	
Code	Description
LS	Standard knob
LH	Knob lever♣

**c**

Operator Function	
Code	Type
M2	Maintained (60° switching angle) ∨
L2	Spring return from left (60° switching angle) 
R2	Spring return from right (60° switching angle) 

**d**

Knob/Insert Color		
Code	Knob Color	Insert Color
0	Amber➤	White
3	Green	White
4	Red	White
5	Yellow➤	Black
6	Blue➤	White
7	Clear	Black

**e**

Orientation	
Code	Description
Blank	Standard
N	90° offset‡

\* LED module required for illumination, can not use incandescent module.

‡ For use in vertical mount enclosures.

§ Crevices may exist on product that may be unsuitable for certain applications. Please consult your local Rockwell Automation sales office or Allen-Bradley distributor.

♣ Only available in clear.

➤ Use of a white LED is recommended.

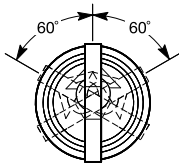


3-Position Selector Switch Operators, Illuminated ‡



**Standard Knob**  
 Cat. No. 800FP-LSM37

Switching Angle



Target Table and Operator Position (60° Switching Angle)				
Contact Type*	Position on Mounting Latch			
N.O.	Left	X	O	O
	Right	O	O	X
N.C.	Left	O	X	X
	Right	X	X	O

Note: X = Closed/O = Open

\* Contact selection is limited to the following options, consult your local Rockwell Automation sales office or Allen-Bradley distributor for other options.

Operator Type 	Pkg. Quantity	Green		Red		Yellow	
		Plastic	Metal	Plastic	Metal	Plastic	Metal
		Cat. No.	Cat. No.	Cat. No.	Cat. No.	Cat. No.	Cat. No.
	1	800FP-LSM33	800FM-LSM33	800FP-LSM34	800FM-LSM34	800FP-LSM35	800FM-LSM35
		800FP-LSR33	800FM-LSR33	800FP-LSR34	800FM-LSR34	800FP-LSR35	800FM-LSR35
		800FP-LSL33	800FM-LSL33	800FP-LSL34	800FM-LSL34	800FP-LSL35	800FM-LSL35
		800FP-LSB33	800FM-LSB33	800FP-LSB34	800FM-LSB34	800FP-LSB35	800FM-LSB35

800F  P - LS   M3   3   e   
           a      b      c      d      e

**a**

Operator Construction	
Code	Description*
P	Round plastic operator (IP66, Type 4/4X/13)
M	Round metal operator (IP66, Type 4/13)

**b**

Operator Type	
Code	Description
LS	Standard knob
LH	Knob lever§

**c**

Operator Function	
Code	Type
M3	Maintained
L3	Spring return from left
R3	Spring return from right
B3	Spring return from left and right

**d**

Knob/Insert Color		
Code	Knob Color	Insert Color
0	Amber➤	White
3	Green	White
4	Red	White
5	Yellow➤	Black
6	Blue➤	White
7	Clear	Black

**e**

Orientation	
Code	Description
Blank	Standard
N	90° offset*

\* LED module required for illumination, can not use incandescent module.

➤ For use in vertical mount 800F enclosures.

‡ Crevices may exist on product that may be unsuitable for certain applications. Please consult your local Rockwell Automation sales office or Allen-Bradley distributor.

§ Only available in clear.

➤ Use of a white LED is recommended.

4-Position Selector Switch Operators, Non-Illuminated



**Standard Knob**  
 Cat. No. 800FP-SM42

Target Table and Operator Position*					
Contact Type§	Position on Mounting Latch				
N.O.	Left	O	O	X	O
	Right	X	O	O	O
	Center	X	O	X	O
	Center CL	O	O	X	O
	Center CR	X	O	O	O
N.C.E.B.	Left	O	O	O	X
	Right	O	X	O	O
	Center CL	O	O	O	X
	Center CR	O	X	O	O
N.C.L.B.	Left	X	X	O	X
	Right	O	X	X	X
	Center	O	X	O	X
	Center CL	X	X	O	X
	Center CR	O	X	X	X

**Note:** X = Closed/O = Open

§ Contact selection is limited to the following options, consult your local Rockwell Automation sales office or Allen-Bradley distributor for other options.

Color	Standard Knob — Maintained		Pkg. Quantity
	Plastic	Metal	
	Cat. No.	Cat. No.	
Black with White Insert	<b>800FP-SM42</b>	<b>800FM-SM42</b>	1

**800F**   **P** - **S**   **M4**   **2**   **e**   **f**

*a*   *b*   *c*   *d*   *e*   *f*

*a*

Operator Construction	
Code	Description
P	Round plastic operator (IP66, Type 4/4X/13)
M	Round metal operator (IP66, Type 4/13)

*c*

Operator Function	
Code	Type
M4	Maintained (45° switching angle) 

*e*

Orientation	
Code	Description
Blank	Standard
N	90° offset*

*b*

Operator Type	
Code	Description
S	Standard knob
H	Knob lever

*d*

Knob/Insert Color		
Code	Knob Color	Insert Color
2	Black	White

*f*

Operation	
Code	Description
Blank	Standard
CL	Center left‡
CR	Center right‡

\* Must use N.O., N.C.E.B., or N.C.L.B. contact blocks only. Cannot use N.C. or N.O.E.M. contact blocks with 4-position selector switch.

‡ For use in vertical mount enclosures.

‡ The center contact block can have the same target output as the left or right contact block, by specifying center left (CL) or center right (CR) option.



2-Position Key-Operated Selector Switches, Non-Illuminated



**Key Selector Switch**  
 Cat. No. 800FP-KM21R

Switching Angle



Target Table and Operator Position*		
Contact Type➤		
N.O.	O	X
N.C.	X	O

Note: X = Closed/O = Open

➤ Contact selection is limited to the following options, consult your local Rockwell Automation sales office or Allen-Bradley distributor for other options.

Key Removal Position	Operator Type		Pkg. Quantity	Key Selector Switch Operators	
				Plastic	Metal
				Cat. No.	Cat. No.
Left			1	800FP-KM21	800FM-KM21
Both				800FP-KM23	800FM-KM23

\* Target table for spring return from left is reversed from what is shown in the table.

800F M - KM2 1

a                  b                  c                  d

**a**

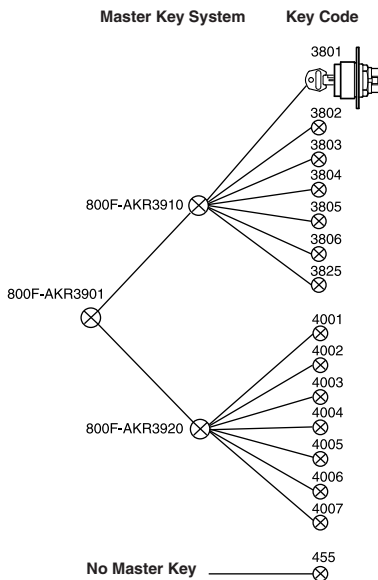
Operator Construction	
Code	Description
P	Round plastic operator (IP66, Type 4/13)
M	Round metal operator (IP66, Type 4/13)

**b**

Operator Type	
Code	Type
KM2	Maintained (60° switching angle)
KL2	Spring return from left (60° switching angle)
KR2	Spring return from right (60° switching angle)

**c**

Key Removal Position*	
Code	Position
1	Left
2	Right
3	Both



**d**

Ronis Key Lock†§*	
Code	Key No.
Blank	3825 (Standard)
R	455
01R	3801
02R	3802
03R	3803
04R	3804
05R	3805
06R	3806
27R	4001
28R	4002
29R	4003
30R	4004
31R	4005
32R	4006
33R	4007

\* Key removal in maintained positions only.

† Keyed operators are IP66, Type 4/13.

§ Not intended for high security applications. Interoperability is possible with certain key/cylinder lock combinations. Consult your local Rockwell Automation sales office or Allen-Bradley distributor for interoperability information.

\* For replacement Ronis keys, see Accessories, page 10-111.

# 22.5 mm Push Buttons

## Product Selection

### 3-Position Key-Operated Selector Switches, Non-Illuminated

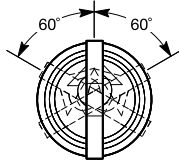


Key-Operated Selector Switch  
Cat. No. 800FP-KM31R



Key-Operated Selector Switch  
Cat. No. 800FM-KM31R

#### Switching Angle



Target Table and Operator Position

Contact Type➤	Position on Mounting Latch			
		N.O.	Left	X
	Right	O	O	X
	Center	X	O	X
N.C.	Left	O	X	X
	Right	X	X	O
	Center	O	X	O

Note: X = Closed/O = Open

➤ Contact selection is limited to the following options, consult your local Rockwell Automation sales office or Allen-Bradley distributor for other options.

Key Removal Position	Operator Position			Pkg. Quantity	Key Selector Switch Operators	
					Plastic	Metal
					Cat. No.	Cat. No.
Left				1	800FP-KM31	800FM-KM31
All					800FP-KM33	800FM-KM33
Center					800FP-KM34	800FM-KM34
Center					800FP-KB34	800FM-KB34

800F  M  -  KM3   3

a                      b                      c                      d

**a**

Operator Construction	
Code	Description
P	Round plastic operator (IP66, Type 4/13)
M	Round metal operator (IP66, Type 4/13)

**b**

Operator Type	
Code	Description
KM3	Maintained
KR3	Spring return from right
KL3	Spring return from left
KB3	Spring return from both

**c**

Key Removal Position*	
Code	Type
1	Left
3	All
4	Center
5	Left/center
7♣	Center/right

**d**

See page 10-83 for optional key codes\*‡§

\* Key removal in maintained positions only.

⊛ Keyed operators are IP66, Type 4/13.

‡ Not intended for high security applications. Interoperability is possible with certain key/cylinder lock combinations. Consult your local Rockwell Automation sales office or Allen-Bradley distributor for interoperability information.

§ For replacement Ronis keys, see Accessories, page 10-111.

♣ Key removal position only valid with operator types 800F\_-KM3 and 800F\_-KL3.



**Emergency Stop Operators\***

**Non-Illuminated Twist-to-Release, Push-Pull**



60 mm Non-Illuminated Twist-to-Release  
 Cat. No. 800FP-MT64



40 mm Non-Illuminated Push-Pull  
 Cat. No. 800FP-MP44

Color	Size	Pkg. Quantity	Twist-to-Release (Trigger Action)		Push-Pull (Trigger Action)	
			Plastic	Metal	Plastic	Metal
			Cat. No.	Cat. No.	Cat. No.	Cat. No.
Red	30	1	800FP-MT34	800FM-MT34	—	—
	40		800FP-MT44	800FM-MT44	800FP-MP44	800FM-MP44
	60		800FP-MT64	800FM-MT64	—	—

**Illuminated — Twist-to-Release, Push-Pull‡**



40 mm Illuminated Twist-to-Release  
 Cat. No. 800FP-LMT44



40 mm Mushroom Push/Pull  
 Cat. No. 800FM-LMP44

Color	Size	Pkg. Quantity	Twist-to-Release (Trigger Action)		Push-Pull (Trigger Action)	
			Plastic	Metal	Plastic	Metal
			Cat. No.	Cat. No.	Cat. No.	Cat. No.
Red	30	1	—	—	800FP-LMP34	800FM-LMP34
	40		800FP-LMT44	800FM-LMT44	800FP-LMP44	800FM-LMP44
	60		800FP-LMT64	800FM-LMT64	800FP-LMP64	800FM-LMP64

**Key Release Mushroom Operator**



40 mm Non-Illuminated Key Release  
 Cat. No. 800FP-MK44

Color	Size	Pkg. Quantity	Ronis Key Lock (Trigger Action)*	
			Plastic	Metal
			Cat. No.	Cat. No.
Red	40 mm	1	800FP-MK44	800FM-MK44

\* All emergency stop operators are EN ISO 13850 compliant with standard NC, NCLB, or self-monitoring contact blocks.

‡ LED module required for illumination, can not use incandescent module.

\* For key options, see page 10-88.

# 22.5 mm Push Buttons

## Product Selection

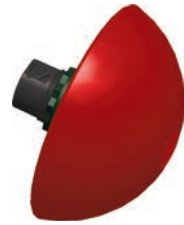
### 2-Position Push-Pull Operators, Non-Illuminated — Twist-to-Release (Trigger Action), Push-Pull (Trigger Action)\*‡



40 mm Trigger Action  
Twist-to-Release Mushroom  
Cat. No. 800FP-MT44



40 mm Trigger Action  
Push-Pull Mushroom  
Cat. No. 800FP-MP44



90 mm Half-Dome  
Cat. No. 800FP-MP94

Color	Pkg. Quantity	40 mm Mushroom (Trigger Action) Twist-to-Release		40 mm Mushroom (Trigger Action) Push-Pull	
		Plastic	Metal	Plastic	Metal
		Cat. No.	Cat. No.	Cat. No.	Cat. No.
Red	1	800FP-MT44	800FM-MT44	800FP-MP44	800FM-MP44

800F P - MT4 4     
           a      b      c      d

**a**

Operator Construction	
Code	Description
P	Round plastic operator (IP66, Type 4/4X/13)
M	Round metal operator (IP66, Type 4/13)

**b**

Operator Type	
Push, Twist-to-Release➤	
Code	Type
MT3	30 mm color cap
MT4	40 mm color cap
MT6	60 mm color cap
Push-Pull‡	
Code	Type
MP4	40 mm color cap
Half-Dome Push-Pull‡	
Code	Type
MP9	90 mm color cap‡

**c**

Color Cap	
Code	Color
2	Black
3	Green
4	Red
5	Yellow
6	Blue

**d‡§\***

Engraving	
Code	Description
Blank	No engraving on cap
LE	EMO laser engraved
E	EMO printed

- \* All emergency stop operators are EN ISO 13850 compliant with standard NC, NCLB, or self-monitoring contact blocks.
- ‡ E-Stop operators, latch, and contact block combinations have been third-party tested for B10d values. B10d values can be found in publication SAFETY-SR001\_EN-E.
- Only available with red color cap.
- ‡ For EMO guards, see page 10-109.
- § Only available on 40 mm color cap.
- \* Only available on red, 40 mm push, twist-to-release operator type (MT44).
- ‡ Half-dome operators only available with black, red, and yellow color caps.
- ‡ Limit of four contact blocks max. for these devices.



# 22.5 mm Push Buttons

## Product Selection

### 2-Position Non-Illuminated Operators — Mushroom, Key Release (Trigger Action)\*♣



40 mm Key Release Mushroom  
Cat. No. 800FP-MK44

Color	Pkg. Quantity	2-Position (Trigger Action) 40 mm Mushroom Key Release	
		Plastic	Metal
Red	1	Cat. No. <b>800FP-MK44</b>	Cat. No. <b>800FM-MK44</b>

**Note:** For replacement Ronis keys, see Accessories, page 10-111. Key release mushroom operators use key no. 3825.

800F  P  -  MK4   4

a                      b                      c                      d

**a**

Operator Construction	
Code	Description
P	Round plastic operator (IP66, Type 4/13)
M	Round metal operator (IP66, Type 4/13)

**b**

Operator Type	
Key Release Mushroom	
Code	Type
MK4	40 mm

**c**

Lens Cap Color	
Code	Color
4	Red

**d**

Ronis Key Lock*‡§	
Code	Key No.
Blank	3825 (Standard)
R	455
01R	3801
02R	3802
03R	3803
04R	3804
05R	3805
06R	3806
27R	4001
28R	4002
29R	4003
30R	4004
31R	4005
32R	4006
33R	4007

- \* All emergency stop operators are EN ISO 13850 compliant with standard NC, NCLB, or self-monitoring contact blocks.
- ♣ E-Stop operators, latch, and contact block combinations have been third-party tested for B10d values. B10d values can be found in publication SAFETY-SR001\_-EN-E.
- ⚙ Keypad operators are IP66, Type 4/13.
- ‡ Not intended for high security applications. Interoperability is possible with certain key/cylinder lock combinations. Consult your local Rockwell Automation sales office or Allen-Bradley distributor for interoperability information.
- § For replacement Ronis keys, see Accessories, page 10-111.

**3-Position Push-Pull Operators, Illuminated & Non-Illuminated — Mushroom\***



**Illuminated 3-Position Push-Pull**  
 Cat. No. 800FM-LMP44E3

Target Table and Operator Position*			
Contact Type†			
	Out	Center	In
N.O.	O	O	X
N.C.E.B.	X	O	O
N.C.L.B.	X	X	O

Note: X = Closed/O = Open

† Contact selection is limited to the following options, consult your local Rockwell Automation sales office or Allen-Bradley distributor for other options.

Operator Function	Operator Type	Color	Pkg. Quantity	Cat. No.
Momentary Out, Maintained Center, Momentary In	Non-Illuminated	Black§	1	800FM-MM42E3
		Green		800FM-MM43E3
		Red➤		<b>800FM-MM44E3</b>
	Illuminated*	Amber‡		<b>800FM-LMM40E3</b>
		Green		<b>800FM-LMM43E3</b>
		Red		<b>800FM-LMM44E3</b>
		Blue‡		800FM-LMM46E3
		Clear‡		800FM-LMM47E3
Momentary Out, Maintained Center, Maintained In	Non-Illuminated	Black§	1	800FM-MP42E3
		Green		800FM-MP43E3
		Red➤		<b>800FM-MP44E3</b>
	Illuminated*	Amber‡		<b>800FM-LMP40E3</b>
		Green		<b>800FM-LMP43E3</b>
		Red		<b>800FM-LMP44E3</b>
		Blue‡		800FM-LMP46E3
		Clear‡		800FM-LMP47E3

**800F**   **M** - **L**   **MM**   **4**   **4**   **E3**  
                   **a**        **b**            **c**            **d**            **e**            **f**

**a**

Operator Construction	
Code	Description
M	Round metal operator (IP66, Type 4/13)

**b**

Operator Type	
Code	Description
Blank	Non-illuminated
L	Illuminated*

**c**

Operator Function	
Code	Description
MM	Momentary out, Maintained center, Momentary in
MP	Momentary out, Maintained center, Maintained in

**d**

Cap Size	
Code	Description
4	40 mm plastic

**e**

Cap Color	
Code	Description
0	Amber‡%§
2	Black§
3	Green
4	Red
6	Blue‡%§
7	Clear‡%§

**f**

Positions	
Code	Description
E3	3-position

- ‡ Sold as stand-alone operator only. Not available as a composite catalog number.
- \* Must use N.O., N.C.E.B., or N.C.L.B. contact blocks only. Cannot use N.C. or N.O.E.M. contact blocks with 3-position push-pull operators.
- § LED module required for illumination. Cannot use incandescent module.
- ‡ Available in illuminated only.
- % Use of white LED is recommended.
- § Available in non-illuminated only.
- Replacement caps are available for this device. Order Cat. No. 800F-AMP4.

# 22.5 mm Push Buttons

## Product Selection

### Momentary Push Button Operators, Non-Illuminated — Mushroom\*



40 mm Mushroom  
Cat. No. 800FM-MM42



60 mm Mushroom  
Cat. No. 800FP-MM63



90 mm Mushroom  
Cat. No. 800FP-MM94

Color	Pkg. Quantity	40 mm Mushroom		60 mm Mushroom	
		Plastic	Metal	Plastic	Metal
		Cat. No.	Cat. No.	Cat. No.	Cat. No.
Black	1	800FP-MM42	800FM-MM42	800FP-MM62	800FM-MM62
Green		800FP-MM43	800FM-MM43	800FP-MM63	800FM-MM63
Red		800FP-MM44	800FM-MM44	800FP-MM64	800FM-MM64
Yellow		800FP-MM45	800FM-MM45	800FP-MM65	800FM-MM65
Blue		800FP-MM46	800FM-MM46	800FP-MM66	800FM-MM66

**800F**    **P**    **- MM4**    **3**  
a    b    c

*a*

Operator Construction	
Code	Description
P	Round plastic operator (IP65, Type 4/4X/13)
M	Round metal operator (IP65, Type 4/13)

*b*

Size and Operator Type	
Code	Type
MM4	40 mm momentary
MM6	60 mm momentary
MM9	90 mm momentary*

*c*

Color Cap	
Code	Color
2	Black
3	Green
4	Red
5	Yellow
6	Blue

\* Momentary mushroom operators are IP65 rated.  
 \* Only available with black, red, and yellow cap colors.





# 22.5 mm Push Buttons

## Product Selection

### 2-Function Momentary Multi-Operator, Non-Illuminated

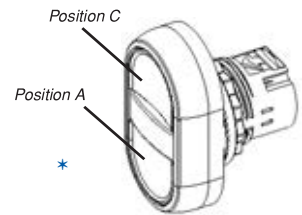


**2-Function Momentary Multi-Operator Non-Illuminated**  
Cat. No. 800FP-U2E4F3

Position A			Position C			Pkg. Quantity	Plastic
Color	Type	Text	Color	Type	Text		Cat. No.
Red	Extended	Blank	Green	Flush	Blank	1	800FP-U2E4F3
		O			I		800FP-U2EFFE
		STOP			START		800FP-U2EBFA

800F P – U2 E 4 F 3 (with button caps)  
*a b c d e f*

800F P – U2 X (without button caps)  
*a b c*



*a*

Operator Construction	
Code	Description
P	Plastic operator (IP66, Type 4/4X)
M	Metal operator (IP66, Type 4)

*b*

Operator Type	
Code	Description
U2	Two-function

*c*

Operator Type — Position A*	
Code	Description
F	Flush
E	Extended
X	No caps (all positions)*

*d*

Operator Color Cap/Text — Position A†	
Code	Description
1	White
2	Black
3	Green
4	Red
5	Yellow
6	Blue
A	Green with "Start" text
B	Red with "Stop" text
C	White with "Start" text
D	Black with "Stop" text
E	Green with "I" text
F	Red with "O" text
G	White with "I" text
H	Black with "O" text

*f*

Operator Color Cap/Text — Position C‡	
Code	Description
1	White
2	Black
3	Green
4	Red
5	Yellow
6	Blue
A	Green with "Start" text
B	Red with "Stop" text
C	White with "Start" text
D	Black with "Stop" text
E	Green with "I" text
F	Red with "O" text
G	White with "I" text
H	Black with "O" text

*e*

Operator Type — Position C*	
Code	Description
F	Flush
E	Extended

10

\* Position 1 of the latch (left position when viewed from the back) corresponds to position A of the operator. Position 2 of the latch (right position when viewed from the back) corresponds to position C of the operator.

\* For custom-engraved caps, order "no caps" option plus custom engraved caps on page 10-115.

‡ Valid color cap/legend text codes include:

Color	Text	
	Flush Caps	Extended Caps
White	START, I	—
Black	—	STOP, O
Green	START, I	—
Red	—	STOP, O

2-Function Momentary Multi-Operator, Illuminated\*

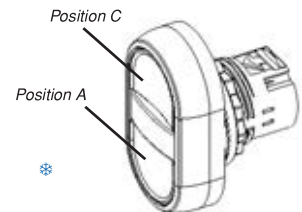


**2-Function Momentary Multi-Operator Illuminated**  
 Cat. No. 800FP-LU2E2E1

Position A			Position B	Position C			Pkg. Quantity	Plastic
Color	Type	Text	Type	Color	Type	Text		Cat. No.
Red	Extended	Blank	White Pilot Light	Green	Flush	Blank	1	800FP-LU2E4F3
		O				I		800FP-LU2EFFE
		STOP				START		800FP-LU2EBFA

800F P - LU2 E 4 F 3 (with button caps)  
           a    b    c    d    e    f

800F P - LU2 X (without button caps)  
           a    b    c



**a**

Operator Construction	
Code	Description
P	Plastic operator (IP66, Type 4/4X)
M	Metal operator (IP66, Type 4)

**b**

Operator Type*	
Code	Description
LU2	Two-function Illuminated

**c**

Operator Type — Position A‡	
Code	Description
F	Flush
E	Extended
X	No caps (all positions)‡

**d**

Operator Color Cap/Text — Position A§	
Code	Description
1	White
2	Black
3	Green
4	Red
5	Yellow
6	Blue
A	Green with "Start" text
B	Red with "Stop" text
C	White with "Start" text
D	Black with "Stop" text
E	Green with "I" text
F	Red with "O" text
G	White with "I" text
H	Black with "O" text

**f**

Operator Color Cap/Text — Position C§	
Code	Description
1	White
2	Black
3	Green
4	Red
5	Yellow
6	Blue
A	Green with "Start" text
B	Red with "Stop" text
C	White with "Start" text
D	Black with "Stop" text
E	Green with "I" text
F	Red with "O" text
G	White with "I" text
H	Black with "O" text

**e**

Operator Type — Position C‡	
Code	Description
F	Flush
E	Extended

\* LED module required for illumination, can not use incandescent module.  
 ‡ Position 1 of the latch (left position when viewed from the back) corresponds to position A of the operator. Position 2 of the latch (right position when viewed from the back) corresponds to position C of the operator. Position 3 of the latch (center position) is reserved for the power module.  
 † For custom-engraved caps, order "no caps" option plus custom engraved caps on page 10-115.  
 § Valid color cap/legend text codes include:

Color	Text	
	Flush Caps	Extended Caps
White	START, I	—
Black	—	STOP, O
Green	START, I	—
Red	—	STOP, O

# 22.5 mm Push Buttons

## Product Selection

### 3-Function Momentary Multi-Operator, Non-Illuminated

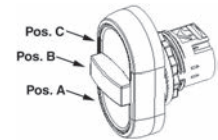


**3-Function Momentary Multi-Operator Non-Illuminated**  
Cat. No. 800FP-U3E4F34

Position A			Position B			Position C			Pkg. Quantity	Plastic
Color	Type	Text	Color	Type	Text	Color	Type	Text		Cat. No.
Green	Flush	Blank	Red	Extended	Blank	Green	Flush	Blank	1	<b>800FP-U3F3F34</b>

**800F** P – U3 E 4 F 3 4 (with button caps)  
*a b c d e f g*

**800F** P – U3 X (without button caps)  
*a b c*  
*a*



**Operator Construction**

Code	Description
P	Plastic operator (IP66, Type 4/4X)
M	Metal operator (IP66, Type 4)

**Operator Type**

Code	Description
U3	Three-function

**Operator Type — Position A\***

Code	Description
F	Flush
E	Extended
X	No caps (all positions)*‡

**Operator Color Cap/Text — Position A§**

Code	Description
1	White
2	Black
3	Green
4	Red
5	Yellow
6	Blue

**Operator Color Cap/Text — Position A§**

Code	Description
A	Green with "Start" text
B	Red with "Stop" text
C	White with "Start" text
D	Black with "Stop" text
E	Green with "I" text
F	Red with "O" text
G	White with "I" text
H	Black with "O" text

**Operator Type — Position C\***

Code	Description
F	Flush
E	Extended

**Operator Color Cap/Text — Position C§**

Code	Description
1	White
2	Black
3	Green
4	Red
5	Yellow
6	Blue

**Operator Color Cap/Text — Position C§**

Code	Description
A	Green with "Start" text
B	Red with "Stop" text
C	White with "Start" text
D	Black with "Stop" text
E	Green with "I" text
F	Red with "O" text
G	White with "I" text
H	Black with "O" text

**Operator Color Cap/Text — Position B\*‡**

Code	Description
4	Red
B	Red with "Stop" text
F	Red with "O" text

\* Position 1 of the latch (left position when viewed from the back) corresponds to position A of the operator. Position 2 of the latch (right position when viewed from the back) corresponds to position C of the operator. Position 3 of the latch (center position) corresponds to position B of the operator.

‡ For custom-engraved caps, order "no caps" option plus custom engraved caps on page 10-115.

‡ For "no caps" option, (position B) center cap available as red, no text only.

§ Valid color cap/legend text codes include:

Color	Text	
	Flush Caps	Extended Caps
White	START, I	—
Black	—	STOP, O
Green	START, I	—
Red	—	STOP, O

Reset Operators — Mechanical and/or Electrical Reset



**Reset Operator**  
 Cat. No. 800FP-R611

Button Color	Legend Text	Pkg. Quantity	Flush — Round	
			Plastic	Metal
Blue	R	1	Cat. No.	Cat. No.
	No Legend		800FP-R611	800FM-R611
			800FP-R6	800FM-R6

800F  $\frac{M}{a}$  -  $\frac{R}{b}$   $\frac{6}{c}$   $\frac{11}{d}$

**a**

Operator Construction	
Code	Description
P	Round plastic operator (IP66, Type 4/4X/13)
M	Round metal operator (IP66, Type 4/13)

**b**

Operator Type	
Code	Type
R	Reset*⊛

**c**

Color Cap	
Code	Color
1	White
2	Black
6	Blue

\* Will accept latch and up to four single circuit contact blocks or two dual circuit contact blocks; no contacts allowed in center position.  
 ⊛ 11 mm reset stroke length.

**d**

Legend Text	
Code	Text
Blank	No text
11	R

Threaded Reset Rod Reset Operators



**Threaded Reset Rod with 35 mm Pusher**  
 Cat. No. 800F-ATR19L

Rod Length [mm]‡	Rod Length Adjustability [mm]	Pkg. Quantity	Threaded Reset Rod	
			10 mm Pusher	35 mm Pusher
			Cat. No.	Cat. No.
40	34...52	1	800F-ATR01	800F-ATR01L
55	50...67		800F-ATR02	800F-ATR02L
85	80...98		800F-ATR04	800F-ATR04L
115	110...128		800F-ATR06	800F-ATR06L
145	141...159		800F-ATR08	800F-ATR08L
315	34...326		§ 800F-ATR19	§ 800F-ATR19L

‡ If contact blocks are used, they must have a minimum rod length of 55 mm for one level of contact blocks and 85 mm for two levels of contact blocks.  
 § Rod is threaded along its entire length for ease of cutting to desired length.

# 22.5 mm Push Buttons

## Product Selection

### Single Turn Potentiometer Assembly\*†§



Series B



Series A

Resistive Element	Series B Cat. No.	Series A Cat. No.*
None (Operator Only)*	<b>800FP-POT</b>	800FP-POTA
150 Ω	<b>800FP-POT1</b>	800FP-POT1A
500 Ω	<b>800FP-POT2</b>	800FP-POT2A
1000 Ω	<b>800FP-POT3</b>	800FP-POT3A
2500 Ω	<b>800FP-POT4</b>	800FP-POT4A
5000 Ω	<b>800FP-POT5</b>	800FP-POT5A
10000 Ω	<b>800FP-POT6</b>	800FP-POT6A

\* The Cat. No. 800FP-POT is a complete operator assembly supplied without the resistive element, used with potentiometers having a shaft diameter of 6.0 mm (0.23 in.) and a shaft length of 50.0 mm (1.97 in.), or a shaft diameter of 6.4 mm (0.25 in.) and a shaft length of 22.5 mm (0.88 in.). This operator is used with Type "J" potentiometers only.

⊛ Rated 300V AC/DC, 2 W max.

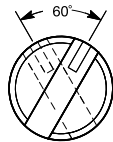
† A latch is not needed.

§ Additional hole spacing required for potentiometers. See page 10-125 for panel hole spacing requirements.

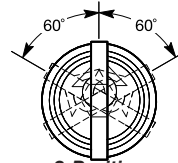
♣ Not stocked. Longer lead-time.

### Key Operated Selector Switch - SensEject™

Patented Spring-Loaded Key Ejection System



2-Position  
Switching Angle



3-Position  
Switching Angle

Operator Construction	Operator Type	Key Eject Position	Key Option§	Spare Keys	Contact Blocks	Cat. No. >
Round Metal Operator — SensEject is IP6X (dust-tight) Type 1	2-Position Maintained		Zadi Key 06Z	800F-AKE006	None	800FM-KEM2106Z
					1 N.O.; 1 N.C.	<b>800FM-KEM2106ZMX11</b>
	3-Position Spring Return from Both		Zadi Key 01Z	800F-AKE001	None	800FM-KEB3401Z
					2 N.O.; 3 N.C.	800FM-KEB3401ZMX23

§ Not intended for high security applications. Interoperability is possible with certain key/cylinder lock combinations. Consult your local Rockwell Automation sales office or Allen-Bradley distributor for interoperability information.

> Includes latch and spacer block.



Selector Push Button Operators\*



**Selector Jog Operator**  
 Cat. No. 800FM-SJ23

Target Table and Operator Position (2-Position)

Contact Type*	Position on Mounting Latch	↙		↗	
		Selector Left Free	Selector Left Depressed	Selector Right Free	Selector Right Depressed
N.O.	Left	O	X	O	O
N.O.	Right	O	O	O	X
N.O.	Center	O	X	O	X
N.C.	Left	X	O	X	X
N.C.	Right	X	X	X	O
N.C.	Center	X	O	X	O

Note: X = Closed/O = Open

Target Table and Operator Position (3-Position)

Contact Type*	Position on Mounting Latch	↙		↑		↗	
		Selector Left Free	Selector Left Depressed	Selector Center Free	Selector Center Depressed	Selector Right Free	Selector Right Depressed
N.O.	Left	O	X	O	X	O	O
N.O.	Right	O	O	O	X	O	X
N.O.	Center	O	X	O	X	O	X
N.C.	Left	X	O	X	O	X	X
N.C.	Right	X	X	X	O	X	O
N.C.	Center	X	O	X	O	X	O

Note: X = Closed/O = Open

\* Contact selection is limited to the following options; consult your local Rockwell Automation sales office or Allen-Bradley distributor for other options.

800F  P  -  SJ   2   2   
           a      b      c      d

a

Operator Construction	
Code	Description
P	Round plastic operator (IP66, Type 4/4X/13)
M	Round metal operator (IP66, Type 4/13)

b

Operator Type	
Code	Description
SJ	Selector jog

c

Operator Function	
Code	Description
2	2-position
3	3-position

d

Color Cap	
Code	Description
2	Black
3	Green

\* Buttons cannot be engraved.

Toggle Switch Operators\*❄



**Toggle Switch Operator**  
 Cat. No. 800FM-JM2

Target Table and Operator Position (2-Position)

Contact Type§	Position on Mounting Latch			
		Toggle Left	Center	Toggle Right
N.O.	Left	O	O	X
N.O.	Right	X	O	O
N.O.	Center	X	O	X
N.C.	Left	X	X	O
N.C.	Right	O	X	X
N.C.	Center	O	X	O

Note: X = Closed/O = Open

Target Table and Operator Position (4-Position)‡

Contact Type§	Position on Mounting Latch					
		Toggle Up	Toggle Left	Center	Toggle Right	Toggle Down
N.O.	Left	X	O	O	O	O
N.O.	Right	O	X	O	O	O
N.O.	Center	X	X	O	O	O
N.C.L.B.	Left	O	X	X	X	X
N.C.L.B.	Right	X	O	X	X	X
N.C.L.B.	Center	O	O	X	X	X
N.C.E.B.	Left	O	O	O	O	X
N.C.E.B.	Right	O	O	O	X	O

Note: X = Closed/O = Open

§ Contact selection is limited to the following options, consult your local Rockwell Automation sales office or Allen-Bradley distributor for other options.

800F           -                      
                   a          b          c

a

Operator Construction	
Code	Description
M	Round metal operator (IP66, Type 4/13)

b

Operator Type	
Code	Description
J	Toggle switch

c

Operator Function	
Code	Description
M2	2-position, maintained
R2	2-position, momentary
M4	4-position, maintained
R4	4-position, momentary

\* Use legend plates 800F-34\_ and 800F-35\_.

❄ Silicone boot comes standard with toggle switch, please see page 10-108 for replacement boots.

‡ Must use N.O., N.C.E.B., or N.C.L.B. contact blocks only. Cannot use N.C. or N.O.E.M. contact blocks with 4-position toggle switch.



**Back-of-Panel Components**

**Contact Blocks with Latch — Composite**

800F – P X 0 1 E  
           *a*    *b*    *c*    *d*    *e*



*a*

Style	
Code	Description
P	Plastic latch
M	Metal latch

*c*

N.O. (Normally Open) Circuits	
Code	Description
0	No contact
1	1 N.O.
2	2 N.O.
3	3 N.O.
4	4 N.O.
5	5 N.O.
6	6 N.O.

*d*

N.C. (Normally Closed) Circuits	
Code	Description
0	No contact
1	1 N.C.
2	2 N.C.
3	3 N.C.
4	4 N.C.
5	5 N.C.
6	6 N.C.

*b*

Contact Block(s) Termination Style*	
Code	Description
X	Screw termination
Q	Spring-clamp termination

*e*

Specialty Contact Block(s)	
Code	Description
Blank	Standard blocks
V	Low voltage — QuadCONNECT™
E	N.O. early make
L	N.C. late break
B	N.C. early break
S	N.C. self-monitoring

\* Six circuits maximum allowable.

**Power Modules with Latch — Composite**

800F – M N 3 G  
           *a*    *b*    *c*    *d*



*a*

Style	
Code	Description
P	Plastic latch
M	Metal latch

*c*

Voltage	
Code	Description
0	No bulb♣
1	6V AC/DC♣
2	12V AC/DC♣
3	24V AC/DC
4	48V AC/DC♣
5	120V AC
7	240V AC➤

*d*

Lamp Color⌘	
Code	Description
C	Incandescent
R	Red LED
G	Green LED
Y	Amber LED
W	White LED
B	Blue LED

*b*

Power Module Type‡§	
Code	Description
D	Incandescent module, screw termination
N	Integrated LED module, screw termination
Q	Integrated LED module, spring-clamp termination

‡ LED modules for use with all illuminated operators. Incandescent module for use with pilot lights, momentary push buttons, and momentary mushroom operators only.

§ Four circuits maximum allowable when power module is used. Contact blocks cannot be stacked on power module.

♣ Only available for incandescent module.

➤ Only available for integrated LED module.

⌘ For best illumination results, LED color should match lens color. For yellow operator, select a white LED.

# 22.5 mm Push Buttons

## Product Selection

### Back-of-Panel Components, Continued

#### Power Modules with Contact Blocks and Latch — Composite

800F –   P     N     5     R     X     1     0     E    
*a* *b* *c* *d* *e* *f* *g* *h*

*a*

Style	
Code	Description
P	Plastic latch
M	Metal latch

*b*

Power Module Type*⊛	
Code	Description
D	Incandescent module, screw termination
N	Integrated LED module, screw termination
Q	Integrated LED module, spring-clamp termination

*c*

Voltage	
Code	Description
0	No bulb‡
1	6V AC/DC‡
2	12V AC/DC‡
3	24V AC/DC
4	48V AC/DC‡
5	120V AC
7	240V AC§

*d*

Lamp Color*	
Code	Description
C	Incandescent
R	Red LED
G	Green LED
Y	Amber LED
W	White LED
B	Blue LED

*e*

Contact Block(s) Termination Style	
Code	Description
X	Screw termination
Q	Spring-clamp termination

*f*

N.O. (Normally Open) Circuits	
Code	Description
0	No contact
1	1 N.O.
2	2 N.O.
3	3 N.O.
4	4 N.O.

*g*

N.C. (Normally Closed) Circuits	
Code	Description
0	No contact
1	1 N.C.
2	2 N.C.
3	3 N.C.
4	4 N.C.

*h*

Specialty Contact Block(s)	
Code	Description
Blank	Standard blocks
V	Low voltage — QuadCONNECT™
E	N.O. early make
L	N.C. late break
B	N.C. early break
S	N.C. self-monitoring

\* Four circuits maximum allowable when power module is used. Contact blocks cannot be stacked on power module.

⊛ LED modules for use with all illuminated operators. Incandescent module for use with pilot lights, push buttons, and momentary mushroom operators only.

‡ Only available for incandescent module.

§ Only available for integrated LED module.

\* For best illuminated results, LED should match lens color. For yellow operator, select a white LED.

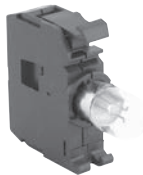





# 22.5 mm Push Buttons

## Product Selection

### Back of Panel Components, Continued

#### Other

	Description	Volts	Pkg. Quantity	Cat. No.
 <p><b>Cat. No. 800F-D3C</b></p>	<p><b>Incandescent Module</b> For use with pilot lights, push buttons, and momentary mushroom operators. <b>Note:</b> Sold in multiples of 10. Order (quantity of) 10 to receive one package of 10 pieces. Latch not included.</p>	No bulb	10	800F-D0C
		6V AC/DC		800F-D1C
		12V AC/DC		800F-D2C
		24V AC/DC		800F-D3C
		48V AC/DC		800F-D4C
		120V AC/DC		800F-D5C
 <p><b>Cat. No. 800F-N3G</b></p>	<p><b>Integrated LED Module</b> For use with all illuminated devices. For best results, LED should match lens color. For amber operators, use yellow LED. <b>Note:</b> Sold in multiples of 10. Order (quantity of) 10 to receive one package of 10 pieces. Latch not included.</p>	24...120V AC/DC	10	* 800F-NUx
		24V AC/DC		* 800F-N3x
		120V AC		* 800F-N5x
		240V AC		* 800F-N7x
		24V AC/DC spring-clamp		* 800F-Q3x
		120V AC spring-clamp		* 800F-Q5x
		240V AC spring-clamp		* 800F-Q7x
		24V AC/DC ring lug		*† 800F-R3x
	Description	Contact Material	Pkg. Quantity	Cat. No.
 <p><b>Cat. No. 800F-BX01</b></p>	<p><b>Base Mounted Contact Block</b> Base mounted contact blocks can be used in plastic or metal enclosures. <b>Note:</b> Sold only in multiples of 10. Order (quantity of) 10 to receive one package of 10 pieces. Latch not included.</p>	N.O.	10	800F-BX10
		N.C.		800F-BX01
		N.O. low voltage — QuadConnect™		800F-BX10V
		N.C. low voltage — QuadConnect™		800F-BX01V
		N.O.E.M.		800F-BX10E
		N.C.L.B.		800F-BX01L
		N.O. spring-clamp		800F-BQ10
		N.C. spring-clamp		800F-BQ01
	Description	Volts	Pkg. Quantity	Cat. No.
 <p><b>Cat. No. 800F-BN3R</b></p>	<p><b>Base Mounted Integrated LED Module</b> Base mounted modules can be used in plastic or metal enclosures. For best illumination results, LED should match lens color. <b>Note:</b> Sold in multiples of 10. Order (quantity of) 10 to receive one package of 10 pieces. Latch not included.</p>	24V AC/DC	10	* 800F-BN3x
		120V AC		* 800F-BN5x
		240V AC		* 800F-BN7x

\* To complete the cat. no., replace the x with one of the following letters for the desired color: **Y** = Amber, **R** = Red, **G** = Green, **B** = Blue, **W** = White.

\* Cannot be used in a composite catalog number.

† Replacement screws are available (Cat. No. 800F-ARS1)

**Plastic and Metal Enclosures**



Plastic Enclosure  
 Cat. No. 800F-3PM



Metal Enclosure  
 Cat. No. 800F-5MM

**Plastic Enclosures (Latch or Base Mounting)**

- Accepts two-piece snap-in legends
- One-hole enclosure accepts 60 mm emergency stop legends
- UL Listed, CSA Certified

**Metal Enclosures (Latch or Base Mounting)**

- Feed-through design
- Accepts two-piece snap-in legends
- Includes base mount adapter

Type	Pkg. Quantity	Enclosures							
		Plastic (IP66, 4/4X)				Metal — Die Cast (IP66, 4/13)*			
		PG Conduit Knockouts		Metric Conduit Knockouts		PG Conduit Openings		Metric Conduit Openings	
		Cat. No.		Cat. No.		Cat. No.		Cat. No.	
1-hole	1	*‡	<b>800F-1PP</b>	*‡	<b>800F-1PM</b>	♣	<b>800F-1MP</b>	♣	<b>800F-1MM</b>
2-hole		*‡	<b>800F-2PP</b>	*‡	<b>800F-2PM</b>	♣	<b>800F-2MP</b>	♣	<b>800F-2MM</b>
3-hole		*‡	<b>800F-3PP</b>	*‡	<b>800F-3PM</b>	♣	<b>800F-3MP</b>	♣	<b>800F-3MM</b>
4-hole		*‡	<b>800F-4PP</b>	*‡	<b>800F-4PM</b>				
5-hole						>	<b>800F-5MP</b>	>	<b>800F-5MM</b>
6-hole		*§	<b>800F-6PP</b>	*§	<b>800F-6PM</b>				
1-hole (yellow)		*	<b>800F-1YP</b>	*	<b>800F-1YM</b>	♣	<b>800F-1MYP</b>	♣	<b>800F-1MYM</b>
1-hole (yellow) latch only						♣	<b>800F-1LYP</b>	♣	<b>800F-1LYM</b>
1-hole (yellow) dual circuit		⊛	<b>800F-1YPD</b>	⊛	<b>800F-1YMD</b>				

- \* Can only use single deep contact block.
- ⊛ Can stack contact blocks two deep or one dual circuit contact block.
- ‡ Knockouts: PG (PG11/16), Metric (M16/20)
- § Knockouts: PG (PG16), Metric (M25)
- ♣ Openings: PG (PG16), Metric (M20)
- > Openings: PG (PG16), Metric (M32)

**Assembled Stations**

Enclosure Material	Operator Type	Illumination Voltage	Contact Configuration	Cat. No.	
				PG Knockouts	Metric Knockouts
1-Hole, Yellow Plastic	Red 90 mm momentary	Non-illuminated	1 N.C.	800F-1YP1M94	800F-1YM1M94
			1 N.O./1 N.C.	800F-1YP2M94	800F-1YM2M94
			2 N.C.	800F-1YP3M94	800F-1YM3M94
1-Hole, Grey Plastic	Black 90 mm momentary		1 N.O./1 N.C.	800F-1PP2M92	800F-1PM2M92
	Black Push Button		1 N.O.	800F-1PP1	800F-1PM1
	"0-1" 2-Position Selector Switch		1 N.O.	800F-1PP2	800F-1PM2
	"OFF-ON" 2-Position Selector Switch		1 N.O. / 1 N.C.	800F-1PP3	800F-1PM3
	↔ (Flush Black)		1 N.O.	800F-1PP4	—
2-Hole, Grey Plastic	Start and Stop Push Buttons		1 N.O./1 N.C.	800F-2PP1	—
3-Hole, Grey Plastic	↑ (Flush Black) O (Extended Red) ↓ (Flush Black)		4 N.O./1 N.C.	<b>800F-3PP1</b>	—

Bulletin 800F  
**22.5 mm Push Buttons**  
 Product Selection

1-Hole Enclosure E-Stop Station



Cat. No. 800F-1YP4

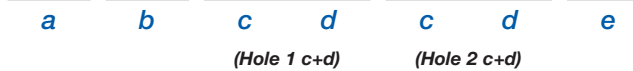
Enclosure Material	Quick Connect	Operator Type	Illumination Voltage	Contact Configuration	Cat. No.	
					PG Knockouts	Metric Knockouts
Yellow Plastic	N/A	Twist-to-Release 40 mm	Non-Illuminated	1 N.C.	<b>800F-1YP1</b>	<b>800F-1YM1</b>
				1 N.O. / 1 N.C.	<b>800F-1YP2</b>	<b>800F-1YM2</b>
		2 N.C.		<b>800F-1YP3</b>	<b>800F-1YM3</b>	
		1 N.C.		800F-1YP4	800F-1YM4	
		1 N.O. / 1 N.C.		800F-1YP5	<b>800F-1YM5</b>	
		2 N.C.		800F-1YP6	800F-1YM6	
		2 N.C.		800F-1YP7	—	
		1 N.O. / 2 N.C.		800F-1YP8	—	
		Twist-to-Release 40 mm	24V AC/DC	1 N.C.	—	800F-1YML1
			120V AC		—	800F-1YML2
		240V AC	—		800F-1YML3	
		Red half dome	Non-illuminated	1 N.C.	800F-1YP1HD	800F-1YM1HD
				1 N.O./1 N.C.	800F-1YP2HD	800F-1YM2HD
				2 N.C.	800F-1YP3HD	800F-1YM3HD
	1 N.C.		24V AC/DC	—	800F-1YML1HD	
			120V AC	—	800F-1YML2HD	
			240V AC	—	800F-1YML3HD	
	AC Micro*	5-pin	Non-Illuminated	2 N.C. — Low voltage	—	800F-1YMQ53V
		6-pin		1 N.O. / 2 N.C.	—	800F-1YMQA
	DC Micro*	4-pin	Non-Illuminated/EMO/Guard	1 N.C.	—	800F-NX1
				1 N.C.	—	800F-1YMQ1
			Non-Illuminated	1 N.O. / 1 N.C.	—	800F-1YMQ2
		2 N.C.		—	800F-1YMQ3	
				—	800F-1YMQ3VEG	
		Mini Receptacle *	4-pin	Non-Illuminated	1 N.C.	—
	24V AC/DC			1 N.O. / 1 N.C.	—	800F-1YMQ44
	6-pin		24V AC/DC	1 N.O./1 N.C.	—	800F-1YMQ4
			120V AC	1 N.O. / 1 N.C.	—	800F-1YMQ5
240V AC	1 N.O. / 1 N.C.	—	800F-1YMQ6			
	N/A	Twist-to-Release 40 mm	Non-Illuminated	1 N.C.	—	800F-1MM1
Twist-to-Release 40 mm		Non-Illuminated	1 N.O. / 1 N.C.	—	800F-1MM2	
Twist-to-Release 40 mm		Non-Illuminated	2 N.C.	—	800F-1MM3	
Key Release 40 mm		Non-Illuminated	1 N.C.	—	800F-1MM4	
Key Release 40 mm		Non-Illuminated	1 N.O. / 1 N.C.	—	800F-1MM5	
Key Release 40 mm		Non-Illuminated	2 N.C.	—	800F-1MM6	
Mini Receptacle *	6-pin	Twist-to-Release 40 mm	24V AC/DC	1 N.O./1 N.C.	—	800F-1MYMQ4
		Twist-to-Release 40 mm	120V AC	1 N.O./1 N.C.	—	800F-1MYMQ5
		Twist-to-Release 40 mm	240V AC	1 N.O./1 N.C.	—	800F-1MYMQ6

\* Please reference Assembled Station Pin Out Chart on page 10-126

Assembled Stations with DeviceNet

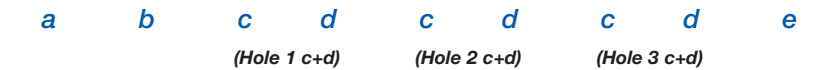
2-Hole

**800F** –



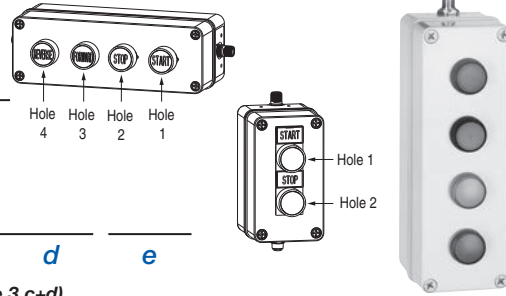
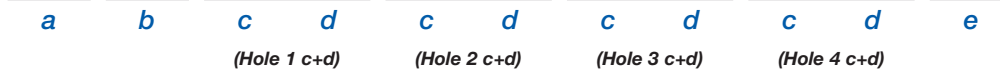
3-Hole

**800F** –



4-Hole

**800F** –



**4-Hole Assembled Station**  
 Cat. No. 800F-VHA3A4J3J4J

**a**

Mounting Orientation	
Code	Description
V	Vertical*
H	Horizontal

**b**

Enclosure Style/Legends	
Code	Description
A	2-hole/legend frames
B	3-hole/legend frames
C	4-hole/legend frames
D	2-hole/no legend frames
E	3-hole/no legend frames
F	4-hole/no legend frames
H	2-hole/E-stop only no legend frames*

**c**

Operator Types	
Code	Description
A	Non-illuminated flush button
B	Non-illuminated extended button
C	Non-illuminated guarded button
D	Illuminated flush button+
E	Illuminated extended button+
F	Illuminated guarded button+
G	Non-illuminated 2-pos. selector switch
H	Non-illuminated 3-pos. selector switch
J	Pilot light (diffused)
K	Hole plug*
L	Non-illuminated TTR E-stop†‡
M	Non-illuminated push pull†‡
N	2-pos. key selector switch
P	3-pos. key selector switch
R	Non-illuminated 40 mm mushroom
T	E-stop key release†‡
U	Potentiometer§
W	Illuminated push pull
X	Illuminated 2-pos. maintained selector switch
Y	Illuminated 3-pos. maintained selector switch
Z	Illuminated 40 mm mushroom

**d**

Color/Text	
Code	Description
1	White
2	Black
3	Green
4	Red
5	Yellow
6	Blue
7	Clear
8	Grey*
9	No cap
0	Amber
A	Green with "Start" text
B	Red with "Stop" text
C	Black with "→" symbol
D	Black with "←" symbol
E	Black with "↑" symbol
F	Black with "↓" symbol
G	Green with "I" symbol
H	Red with "O" symbol
L	Blue with "R" text
M	Red with yellow metal guard*
N	Yellow with yellow metal guard*

**e**

I/O Version➤	
Code	Description
Blank	No external I/O
A	1 input/1 output (sinking)
B	1 input/1 output (sourcing)
C	2 input
D	2 output (sinking)
E	2 output (sourcing)
F	1 E-stop block‡
G	2 E-stop block‡
H	2 input/2 output
J	2 input/2 output (sinking)
K	2 input/2 output (sourcing)
L	1 input/1 output (sinking) + 1 E-stop block‡
M	1 input/1 output (sourcing) + 1 E-stop block‡
N	1 input/1 output (sinking) + 2 E-stop block‡
P	1 input/1 output (sourcing) + 2 E-stop block‡
Q	2 input + 1 E-stop block‡
R	2 input + 2 E-stop block‡
T	2 output (sinking) + 1 E-stop block‡
U	2 output (sourcing) + 1 E-stop block‡
V	2 output (sinking) + 2 E-stop block‡
W	2 output (sourcing) + 2 E-stop block‡
X	2 input + 1 input/1 output (sinking)
Y	2 input + 1 input/1 output (sourcing)

- \* Selector Switches in a vertical mount enclosure are mounted with a horizontal orientation.
- \* Enclosure Style/Legend option H from Table b can only select one operator from Table c. Valid options are L, M and T. Also see footnote †
- † Operator Types L, M, and T from Table c may be used as emergency stops. To be valid as an E-Stop, operators must use color/text option 4 from Table d and it must be placed in the last hole position in the enclosure, where a yellow round E-stop legend plate is provided. An E-Stop connector also must be chosen from Table e. Also see footnote ‡
- ‡ Potentiometer allowed in first hole position only.
- § Available in flush only.
- This is an 8-in/4-out device. 2-in and 1-out are assigned to each hole position in the enclosure. If a 2-hole enclosure is selected, 4-in and 2-out are assigned internally and up to 4 unassigned I/O points can be assigned to external connectors. This device contains up to two physical external I/O connectors. The "+" symbol in the Description field of table e indicates that two external connectors exist. If an E-Stop connector is used, 2 unassigned I/O points can be assigned to the other connector.
- ‡ External I/O Versions F, L, M, Q, T, and U receive only one contact block for the external E-Stop string. These connectors are rated 3 A. If more than 3 A of current is needed or if there are two E-Stop strings, use External I/O Versions G, N, P, R, V and W. These versions receive two contact blocks. This allows for 6 A of switching or for two E-Stop strings.
- † Cannot be ordered with "No Cap" (9 from Table d - Color/Text).
- ‡ Operator Types K, L, M, T, and U from Table c are not available with legend frames.
- \* Only available with non-illuminated push-pull operator (M from Table c).



# 22.5 mm Push Buttons

## Product Selection

### Pendant Stations (Latch Mounting)\*

- Blank legend cap marking
- Connector not included. See Accessories, page 10-107, for ordering information.



**Pendant Station**  
Cat. No. 800F-P25

Type	Pkg. Quantity	Pendants	
		Yellow Plastic (IP66, 4/4X/13)	
		Cat. No.	
1 hole in face	1	800F-P15	
2 holes in face		800F-P25	
1 hole in bottom		800F-P35	
1 hole in face / 1 hole in bottom		800F-P45	

### Assembled Two-Hole Pendant Stations\*












**Pendant Station**  
Cat. No. 800F-PN2

<b>Pre-Wired Pendant Station with Mini Quick Disconnect Connector</b>	
Push Button and Contact Selection	Cat. No.
Green flush (no text) in face with 1 N.O. contact; Red pilot light in bottom with 1 N.O. contact; 24V AC/DC	800F-PN2
White flush (with up arrow — ↑) with 1 N.O./1 N.C. contact; Black flush (with down arrow — ↓) with 1 N.O./1 N.C. contact	800F-P251
Black flush (with "Forward" text) with 1 N.O./1 N.C. contact; Black flush (with "Reverse" text) with 1 N.O./1 N.C. contact	800F-P252
Black flush (with "On" text) with 1 N.O. contact; Black flush (with "Off" text) with 1 N.C. contact	800F-P253
Green flush (with "Start" text) with 1 N.O. contact; Red flush (with "Stop" text) with 1 N.C. contact	800F-P254
2 flush black push buttons (no text), each with 1 N.O. contact	800F-P255
<b>DeviceNet Pendant Station with Mini Quick Disconnect Connector</b>	
Options	Cat. No.
Green flush push button in face, red pilot light in bottom; 24V DC	800F-PND2

\* Can only use single deep contact block.

Miscellaneous








	Description	Type	Pkg. Quantity	Cat. No.
 Cat. No. 800F-AHA1	<b>30.5 mm to 22.5 mm Hole Size Adapter</b> This adapter allows a 22.5 mm push button operator to be installed in a panel with existing 30.5 mm mounting holes. <b>Note:</b> Comes with anti-rotation washer (800F-ALC1).	Metal	1	800F-AHA1
 Cat. No. 888N-M4AF1-1F	<b>Quick Disconnect</b> Male receptacle for pendant stations.	4-pin		888N-M4AF1-1F
		5-pin		888N-M5AF1-1F
	Description	Material	Pkg. Quantity	Cat. No.
 Cat. No. 800F-ARP	<b>Replacement Mounting Rings</b>	Plastic	10*	800F-ARP
		Metal		800F-ARM
	Description		Pkg. Quantity	Cat. No.
 Cat. No. 800F-AW2	<b>Mounting Ring Wrench</b> This mounting ring wrench is used to tighten plastic or metal mounting rings quickly and securely.		1	800F-AW2
 Cat. No. 800F-ALR1	<b>Bulb Removal Tool</b> For quick and easy removal of lamps from incandescent modules.			800F-ALR1
 Cat. No. 1492-MS5X9	<b>Snap-In Marker</b> This item can be used for circuit identification on all back-of-panel components.		—	*
 Cat. No. 800F-ATK2	<b>Stab Terminals</b> Can be used with all single circuit contact blocks. Minimum spacing requirements apply. See instruction sheet for details. <b>Note:</b> Sold only in multiples of 100. Order (quantity of) 100 to receive one package of 100 pieces.		100	800F-ATK2
 Cat. No. 800F-AGS1	<b>Ground Screws</b> These are self-tapping #6-32 (M3.5) ground screws for metal latches.		10*	800F-AGS1
 Cat. No. 800F-AGS2	<b>Ground Screws</b> This accessory is used for grounding on Bulletin 800F plastic enclosures only.			800F-AGS2

\* See Terminal Block section for ordering information.

\* Sold only in multiples of 10. Order (quantity of) 10 to receive one package of 10 pieces.






10

Miscellaneous, Continued

	Description	Panel Thickness with Legend Plates	Pkg. Quantity	Cat. No.
 Cat. No. <b>800F-ALC1</b>	<b>Locking Washer (Anti-Rotation Washer)</b> This item provides an extra anti-rotation feature for rotary operators such as selector switches.	1...4 mm	10‡	<b>800F-ALC1</b>
		1...5 mm		<b>800F-ALC2</b>
Description				
 Cat. No. <b>800F-ATW1</b>	<b>Replacement Trim Washer</b> This accessory comes standard with all enclosures. It must be used if using base-mounted contact blocks/power modules without legend plates.		10‡	<b>800F-ATW1</b>
 Cat. No. <b>800F-A3BA</b>	<b>Replacement Base Mount Adapter</b> This accessory comes standard with all metal enclosures. It is required when using metal enclosures with base-mounted contact blocks or base-mounted power modules.			<b>800F-A3BA</b>
 Cat. No. <b>800F-ABZ1</b>	<b>Square Bezel</b> Gives round operator a square appearance. This item is made of plastic. Not for use with toggle switch operators.			<b>800F-ABZ1</b>
Description				
		Material	Pkg. Quantity	Cat. No.
 Cat. No. <b>800F-ABJS</b>	<b>Replacement Boot for Toggle Switch</b>	Silicone	1	<b>800F-ABJS</b>
		Nitrile		<b>800F-ABJN</b>
 Cat. No. <b>800F-N2</b>	<b>Hole Plug</b> used to plug 22.5 mm holes.	Black plastic		<b>800F-N2</b>
		Grey plastic		<b>800F-N8</b>
 Cat. No. <b>800F-ACP</b>	<b>Selector Switch Tabs</b> Changes functionality of selector switch from normal to CenterLeft or CenterRight.		10‡	<b>800F-ACP</b>








‡ Sold only in multiples of 10. Order (quantity of) 10 to receive one package of 10 pieces.

**Guards**






	Description	Type	Pkg. Quantity	Cat. No.
 Cat. No. 800F-AMRG	<b>Protective Ring</b> for use with non-illuminated 2-position maintained and illuminated/non-illuminated 3-position mushroom operators (40 mm only)	Shiny metal	1	800F-AMRG
		Black		800F-AMRGB
		Yellow Metal		800F-AMRGY
 Cat. No. 800F-A6PR5	<b>Plastic Guard</b> for use with the following operators: <ul style="list-style-type: none"> <li>• 40 mm E-stop (SEMI Standards Compliant)</li> <li>• 40 mm illuminated/non-illuminated alternate action and momentary operators</li> <li>• 60 mm illuminated/non-illuminated momentary operators</li> <li>• Selector switches (standard knob and key operated)</li> <li>• Potentiometers</li> </ul>	Yellow, round	1	800F-A6PR5
 Cat. No. 800F-AMEGY	<b>Narrow Plastic Guard</b> for use with the following operators: <ul style="list-style-type: none"> <li>• Illuminated and non-illuminated momentary mushroom operators (40 mm) only</li> <li>• Bul. 800FD monolithic E-stops (SEMI standards compliant)</li> <li>• Flush/extended/guarded push buttons</li> <li>• Alternate action operators</li> <li>• Selector switches (standard knob and key operated)</li> <li>• Potentiometers</li> </ul>	Yellow		800F-AMEGY
 Cat. No. 800F-AMMG	<b>40 mm Protective Guard</b> used with illuminated and non-illuminated momentary mushroom operators (40 mm) only.	Shiny Metal		800F-AMMG
 Protective Boots	Clear silicone <b>Protective Boot</b> used on illuminated and non-illuminated, flush and extended operators.	Flush push button	10*	800F-AB7
		Extended push button		800F-ABE7
		3-position multi-function		800F-AUB1
		2-position multi-function		800F-AUB2

\* Sold in multiples of 10. Order (quantity of) 10 to receive one package of 10 pieces.

## Locking Attachments




	Description	Type	Pkg. Quantity	Cat. No.
 <i>Cat. No. 800F-AFL1</i>	<b>Locking Attachments</b> are used to lock push button in the depressed position. -N.C. contacts are open -N.O. contacts may or may not be open -N.C.L.B. contacts may or may not be closed -N.O.E.M contacts are closed	Flush momentary, non-illuminated	1	<b>800F-AFL1</b>
 <i>Cat. No. 800F-AEL1</i>		Extended momentary, non-illuminated		<b>800F-AEL1</b>
 <i>Cat. No. 800F-AML1</i>		Momentary mushroom		<b>800F-AML1</b>
 <i>Cat. No. 800F-AML2</i>		Maintained mushroom		<b>800F-AML2</b>
	Description	Lock Position	Pkg. Quantity	Cat. No.
 <i>Cat. No. 800F-ASL2L</i>	<b>Selector Switch Locking Attachment</b> Locks standard knob selector switch in specified position	2-position selector switches, left lock	1	<b>800F-ASL2L</b>
		3-position selector switches, center lock		<b>800F-ASL3C</b>
 <i>Cat. No. 800F-ASL23A</i>	<b>Selector Switch Locking Attachment</b> Ability to put two locks on standard knob selector switch.	2- or 3-position selector switches, all positions		<b>800F-ASL23A</b>
	Description	Type	Pkg. Quantity	Cat. No.
 <i>Cat. No. 800F-AL01</i>	<b>Locking Cover</b> Used on flush, extended and guarded momentary and alternate action operators, and standard knob selector switch operators.	—	1	<b>800F-AL01</b>

Other Accessories

	Description	PQ	Key No. (Std)	Cat. No.	Key No. (Std)	Cat. No.
 Cat. No. 800F-AKR3825	<b>Replacement Ronis Key</b> Standard replacement key is Cat. No. 800F-AKR3825.	1*	3825	<b>800F-AKR3825</b>	3910*	<b>800F-AKR3910</b>
			455	<b>800F-AKR455</b>	3920*	800F-AKR3920
			3801	<b>800F-AKR3801</b>	4001	<b>800F-AKR4001</b>
			3802	<b>800F-AKR3802</b>	4002	800F-AKR4002
			3803	<b>800F-AKR3803</b>	4003	800F-AKR4003
			3804	800F-AKR3804	4004	800F-AKR4004
			3805	800F-AKR3805	4005	800F-AKR4005
			3806	800F-AKR3806	4006	800F-AKR4006
			3901*	<b>800F-AKR3901</b>	4007	800F-AKR4007
Description				Volts	PQ	Cat. No.
 Cat. No. 800F-XD7	<b>Diode Module</b> For lamp checking circuits. Latch not included.			up to 600V AC	10‡	<b>800F-XD7</b>
	<b>Null Block</b> For wire terminations only.					800F-NX70
Description				PQ	Cat. No.	
 Cat. No. 800F-30WN	<b>Potentiometer Legend Plate</b> Scale 1...10			10‡	<b>800F-30WN</b>	
 Cat. No. 800F-30WG	<b>Potentiometer Legend Plate</b> Graphical scale				<b>800F-30WG</b>	
Description				Resistance	PQ	Cat. No.
 Cat. No. 800F-AC1	<b>Replacement Resistive Elements</b> for the 800FP Potentiometer operator.		150 Ω	1	<b>800F-AC1</b>	
			500 Ω		<b>800F-AC2</b>	
			1000 Ω		<b>800F-AC3</b>	
			2500 Ω		<b>800F-AC4</b>	
			5000 Ω		<b>800F-AC5</b>	
			10000 Ω		<b>800F-AC6</b>	

PQ = Pkg. Quantity  
 \* Master key. See page 10-83 for details.  
 † Standard package quantity is one set with two keys.  
 ‡ Sold only in multiples of 10. Order (quantity of) 10 to receive one package of 10 pieces.

Replacement Lamps for Incandescent Module

Lamp	Type	Typical Current	Voltage	ANSI No.	Pkg. Quantity	Cat. No.	
 Cat. No. 800F-N130	Full Voltage Incandescent	150 mA	6V AC/DC	755	10§	<b>800F-N65</b>	
		80 mA	12V AC/DC	756		800F-N141	
		70 mA	24V AC/DC	757		<b>800F-N157</b>	
		50 mA	48V AC/DC	1835		<b>800F-N48</b>	
		22 mA	130V AC/DC	949		<b>800F-N130</b>	
 Cat. No. 800F-N240	Neon	2 mA	240V AC	—			<b>800F-N240</b>
	LED	50 mA	6V AC/DC	—			♣ 800T-N318x
		12 mA/17 mA	32V AC/DC	—			♣ 800T-N363x
		9 mA/14 mA	48V AC/DC	—			♣ 800T-N364x
		4.5 mA/6.2 mA	130V AC/DC	—			♣ 800T-N321x

§ Sold in multiples of 10. Order (quantity of) 10 to receive one package of 10 pieces.  
 ♣ To complete the cat. no., replace the x with one of the following letters for the desired color: **A** = Amber; **B** = Blue; **G** = Green; **R** = Red; **W** = White. White LEDs only available in 6V and 130V.


# 22.5 mm Push Buttons

## Accessories


### Caps, Diffusers, Lenses

Color caps listed below are for completion of devices ordered with color caps omitted.


#### Accessory Color Caps (without Text)

Color Caps, Non-Illuminated*					
	Color	Pkg. Quantity	Momentary Extended	Momentary Flush/Guarded	Alternate Action Flush
			Cat. No.	Cat. No.	Cat. No.
	Orange	10	800F-AE0	800F-AF0	800F-AFA0
	White		<b>800F-AE1</b>	<b>800F-AF1</b>	800F-AFA1
	Black		<b>800F-AE2</b>	<b>800F-AF2</b>	800F-AFA2
	Green		<b>800F-AE3</b>	<b>800F-AF3</b>	<b>800F-AFA3</b>
	Red		<b>800F-AE4</b>	<b>800F-AF4</b>	800F-AFA4
	Yellow		<b>800F-AE5</b>	<b>800F-AF5</b>	800F-AFA5
	Blue		<b>800F-AE6</b>	<b>800F-AF6</b>	800F-AFA6
	Grey		—	<b>800F-AF8</b>	—

#### Accessory Color Caps — Multi-Function Operators (without Text)

Color Caps, Non-Illuminated*				
	Color	Pkg. Quantity	Flush	Extended
			Cat. No.	Cat. No.
	White	10	800F-AFU1	<b>800F-AEU1</b>
	Black		800F-AFU2	<b>800F-AEU2</b>
	Green		800F-AFU3	800F-AEU3
	Red		800F-AFU4	800F-AEU4
	Yellow		800F-AFU5	800F-AEU5
	Blue		800F-AFU6	800F-AEU6


#### Accessory Color Lens Caps and Pilot Light Lenses (without Text)

	Color	Pkg. Quantity	Illuminated Color Lens Caps* — Flush, Alternate Action	Illuminated Color Lens Caps* — Extended, Guarded	Pilot Light Lenses** — Standard Lens
			Cat. No.	Cat. No.	Cat. No.
	Amber	10	<b>800F-ALF0</b>	<b>800F-ALE0</b>	<b>800F-AP0</b>
	Green		<b>800F-ALF3</b>	<b>800F-ALE3</b>	<b>800F-AP3</b>
	Red		<b>800F-ALF4</b>	<b>800F-ALE4</b>	<b>800F-AP4</b>
	Yellow		<b>800F-ALF5</b>	<b>800F-ALE5</b>	<b>800F-AP5</b>
	Blue		<b>800F-ALF6</b>	800F-ALE6	<b>800F-AP6</b>
	Clear		<b>800F-ALF7</b>	<b>800F-ALE7</b>	<b>800F-AP7</b>

\* Sold only in multiples of 10. Order (quantity of) 10 to receive one package of 10 pieces.

\*\* Includes diffuser.

#### Operator Diffusers (without Text)

Diffusers			
	Description	Pkg. Quantity	Cat. No.
 <p><b>Cat. No. 800F-AD3</b></p>	Illuminated Push Buttons — Flush	10	<b>800F-AD2</b>
	Pilot Lights		<b>800F-AD3</b>
	Illuminated Push Buttons — Extended, Guarded		800F-AD4

10





Two-Color Molded Legend Caps — Non-Illuminated Push Buttons

800F – AF    3    01  
                   a            b            c



Cat. No. 800F-15YSE112

**a**

Button Cap Type	
Code	Description
AF	Flush
AE	Extended

**b**

Color Cap	
Code	Description
1	White
2	Black
3	Green
4	Red
5	Yellow
6	Blue

**c**

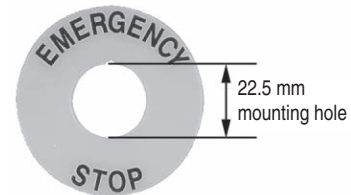
Legend Text*†	
English	
Code	Description
01	START
02	STOP
05	O
06	I
08	→
09	FORWARD*
10	REVERSE*
11	R

\* Available in flush only.  
 \* White and yellow caps have black text. All other color caps have white text.  
 † Valid color cap text codes include:

Color	Text	
	Flush Caps	Extended Caps
White	FORWARD, REVERSE, START, I, →, R	→, R
Black	FORWARD, REVERSE, →, R	STOP, O, →, R
Green	FORWARD, REVERSE, START, I, →	→
Red	FORWARD, REVERSE, STOP, O, →	STOP, O, →
Yellow	FORWARD, REVERSE, →	→
Blue	FORWARD, REVERSE, →, R	→, R

Emergency Stop Legend Plates§

800F – 15YS              
                   a            b



**a**

Size/Color (Yellow)	
Code	Description
15Y	60 mm round (30.5 mm mounting hole)
15YS	60 mm round (22.5 mm mounting hole)➤
16Y	90 mm round (22.5 mm mounting hole)➤

**b**

Text	
Code	Description
Blank	No text
E112	EMERGENCY STOP
F112	ARRÊT D'URGENCE‡
S112	PARADA DE EMERGENCIA
G112	NOT HALT
T112	ARRESTO EMERGENZA
N112	NÖDSTOPP, EMERGENCY STOP‡

**b (cont'd)**

Text	
Code	Description
W112	NÖDSTOPP, EMERGENCY STOP‡
A112	NÖDSTOP
B112	EMERGENCY STOP, ARRÊT D'URGENCE, PARADA DE EMERGENCIA‡
D112	NOODSTOP‡
M112	NOT HALT, ARRESTO EMERGENZA, ARRÊT D'URGENCE➤
	EMERGENCY STOP, ARRÊT D'URGENCE, NOT HALT❖
L112	NEYDARSTOPP, NEYDARSTOPP‡
H112	NÖD-STOP, HÄTÄ-SEIS, NÖD-STOP‡

§ Sold only multiples of 10. Order (quantity of) 10 to receive one package of 10 pieces.  
 ➤ Not for use with base mounted contact blocks.  
 ‡ Not available on 15YS version.  
 ➤ Text printed on the 15Y version only.  
 ❖ Text printed on the 15YS & 16Y versions only.

10

# 22.5 mm Push Buttons

## Accessories

### Legend Plates

#### Ordering Information\*§

#### Standard Text/Symbols

1. Select the cat. no. for the appropriate legend size and color from the Selection Tables on this page.
2. Complete the cat. no. by adding the appropriate suffix no. selected from pages 10-116...10-119. Font size is automatically determined by the number of characters, as shown in the following table. Do not add the font code to the cat. no.

Font Size	No. of Characters		
	One-Piece Legend Plate	Two-Piece Legend Plate	Special Multi-Function Legend Plate
K (small)	>14	>13	>6
S (standard)	≤14	≤13	≤6

Example: **Cat. No. 800F-11WE101** identifies a white, 30 x 40 mm snap-in legend plate and frame with AUTO engraved on it.



#### Custom Text (text found on pages 10-116...10-119)

1. Select the cat. no. for the appropriate legend size and color from the Selection Tables on this page.
2. Add **E100** followed by the font code (K, S, L) from the following table.

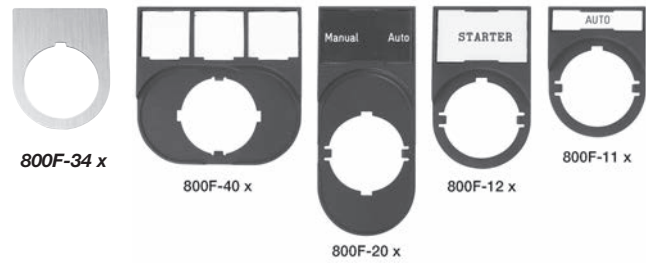
Font Size	Type of Legend Plate							
	One-Piece						Special Multi-Function	
	Max. Char. per Line	Max. No. of Lines		Max. Char. per Line	Max. No. of Lines		Max. Char. per Line	Max. No. of Lines
		30 x 40 mm	30 x 50 mm		30 x 40 mm	30 x 50 mm or 30 x 60 mm		
K (small)	16	2	5	15	2	5	7	3
S (standard)	14	2	3	13	1	3	6	3
L (large)	10	1	3	9	1	3	4	2

3. Complete the cat. no. by adding custom text to the order item's memo text or notes field.

Example: **Cat. No. 800F-12WE100K**, with **STARTER** text entered into memo text on order, identifies a white, 30 x 50 mm snap-in legend plate and frame with custom text STARTER engraved in small font.



### Selection Tables\*



Type	Description	Cat. No. (Blank)	Cat. No. (with Text Symbols)
30 x 40 mm 2-piece snap-in plate and frame	Red with white text	800F-11RE100	800F-11R□□□□
	White with black text	<b>800F-11WE100</b>	800F-11W□□□□
	Black with white text	<b>800F-11BE100</b>	800F-11B□□□□
30 x 50 mm 2-piece snap-in plate and frame	Aluminum with black text	800F-11AE100	800F-11A□□□□
	White with black text	<b>800F-12WE100</b>	800F-12W□□□□
	Black with white text	<b>800F-12BE100</b>	800F-12B□□□□
30 x 60 mm 2-piece snap-in plate and frame	Aluminum with black text	800F-12AE100	800F-12A□□□□
	White with black text	800F-20WE100	800F-20W□□□□
	Black with white text	800F-20BE100	800F-20B□□□□
Special multi-function 4-piece snap-in plates and frame	Aluminum with black text	800F-20AE100	800F-20A□□□□
	White with black text	800F-40WE100	—
	Black with white text	800F-40BE100	—
30 x 40 mm 1-piece	Aluminum with black text	800F-40AE100	—
	Red with white text	800F-34RE100	800F-34R□□□□
	White with black text	<b>800F-34WE100</b>	800F-34W□□□□
30 x 50 mm 1-piece	Black with white text	<b>800F-34BE100</b>	800F-34B□□□□
	Aluminum with black text	<b>800F-34AE100</b>	800F-34A□□□□
	Red with white text	<b>800F-35RE100</b>	800F-35R□□□□
30 x 40 mm snap-in plate only	White with black text	<b>800F-35WE100</b>	800F-35W□□□□
	Black with white text	<b>800F-35BE100</b>	800F-35B□□□□
	Aluminum with black text	<b>800F-35AE100</b>	800F-35A□□□□
30 x 50 mm snap-in plate only	Red with white text	800F-17RE100	800F-17R□□□□
	White with black text	<b>800F-17WE100</b>	800F-17W□□□□
	Black with white text	800F-17BE100	800F-17B□□□□
30 x 60 mm 1-piece	Aluminum with black text	800F-17AE100	800F-17A□□□□
	White with black text	800F-18WE100	800F-18W□□□□
	Black with white text	<b>800F-18BE100</b>	800F-18B□□□□
Special multi-function snap-in plate only‡	Aluminum with black text	800F-18AE100	800F-18A□□□□
	White with black text	800F-42WE100	800F-42W□□□□
	Black with white text	800F-42BE100	800F-42B□□□□
30 x 50 mm 1-piece	Aluminum with black text	800F-42AE100	800F-42A□□□□
	Yellow with black text	800F-37YE100	800F-37Y□□□□

#### Legend Plate Frame — 2-Piece Snap-In\*

Type	Cat. No.	Type	Cat. No.
30 x 40 mm	<b>800F-110</b>	30 x 60 mm	<b>800F-200</b>
30 x 50 mm	<b>800F-120</b>	Special multi-function‡	800F-400

\* Blank legend frames sold only in multiples of 10. Order (quantity of) 10 to receive one package of 10 pieces. Legends with standard text/symbols or custom text are packaged in quantities of 1.

§ Font code **K** = 0.08 in; font code **S** = 0.10 in; font code **L** = 0.14 in.

‡ Three snap-in plates are required for each legend frame.

§ For configuration assistance, see RAISE product selection software.

\* Plate dimensions found on pages 10-122...10-123.

**Custom Laser-Engraved Caps and Diffusers**

**Ordering Information\*\*§**

**Standard Text/Symbols**

1. Select the cat. no. for the appropriate product and color from the Configurator Tables on this page.
2. Complete the cat. no. by adding the appropriate suffix no. selected from pages 10-116...10-119.

Example: **Cat. No. 800F-AF3CE166** identifies a flush, green cap with custom-engraved text ON.

3. Font size is automatically determined by the number of characters. ‡ Do not add a font code to the cat. no.

Font Size	No. of Characters
12 pt.	7
16 pt.	5...6
20 pt.	1...4

**Custom Text (text found on pages 10-116...10-119)**

1. Select the cat. no. for the appropriate product and color from the Configurator Tables on this page.
2. Add **E100** followed by the font code (G, H, J), based on the number of custom characters.
3. Complete the cat. no. by adding custom text to the order item's memo text or notes field.

Example: **Cat. No. 800F-AF3CE100J**, with **FILL** text entered into memo text on order, identifies a flush, green push button cap with custom laser-engraved text FILL in large font.

Font Size	No. of Characters	Max. No. of Lines
G (small) (12 pt.)	7	1
H (standard) (16 pt.)	5...6	1
J (large) (20 pt.)	1...4	1

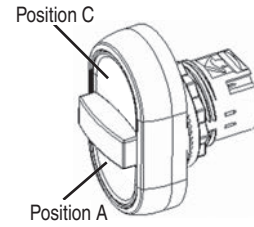
**Custom Symbols/Graphics (symbols found on page 10-116)**

1. Select the cat. no. for the appropriate product and color from the Configurator Tables on this page.
2. Add U100 to identify the custom symbol or graphic.
3. Please contact your local Allen-Bradley sales office to submit the graphic.

Example: **Cat. No. 800F-AD3CU100**

- \* Package quantity of one for all laser-engraved caps and diffusers.
- ‡ Standard font is Arial Narrow.
- ‡ Seven characters maximum allowable.
- § For configuration assistance, see RAISE product selection software.

**Configurator Tables**



**Multi-Function Cap Positions**

**Push Button, Multi-Function Caps**

800F - A  $\frac{F}{a}$   $\frac{1}{b}$  C

Type	
Code	Description
E	Push button extended cap
F	Push button flush cap
FA	Alternate action cap
FAU	Multi-function flush cap (for position A)
EAU	Multi-function extended cap (for position A)
FCU	Multi-function flush cap (for position C)
ECU	Multi-function extended cap (for position C)

Color	
Code	Description
0	Amber
1	White
2	Black
3	Green
4	Red
5	Yellow
6	Blue

**Pilot Light Diffuser**

800F - AD3C

**Illuminated Push Button Diffusers**

800F - AD2C (Flush or Alternate Action)

800F - AD4C (Extended and Guarded)

## Legend Texts

## Standard Symbols\*

Marking	Description	Std.	Suffix No.
(Blank)	Blank	—	U100
	—	—	U112
	START*†§♣	ISO 71	U219
	—*†§♣	ISO 72	U220
	START*†§♣	ISO 5232	U221
	CONTINUOUS MOTION LEFT, RIGHT ➤	—	U226
	CONTINUOUS MOTION UP, DOWN ➤	—	U227
O	STOP	—	U228
I	STEP 1	—	U229
II	STEP 2	—	U230
O-I	STOP-START ➤	—	U231
I-O	START-STOP ➤	—	U232
I-II	— ➤	—	U233
I-O-II	— ➤	—	U234
	— ➤	—	U236
	— ➤	—	U237
I-II-III	— ➤	—	U240
	CONTINUOUS MOTION	—	U241
	CONTINUOUS MOTION	—	U242
	CONTINUOUS MOTION	—	U243
III	STEP 3	—	U249
O ➤	— ➤	—	U256
I-O-I	START-STOP-START ➤	—	U282
O-1-2	— ➤	—	U285
IV	STEP 4	—	U604
V	STEP 5	—	U605
	CONTINUOUS MOTION	ISO 1	U700
	LINEAR MOTION TWO DIRECTIONS	ISO 2	U701
	VERTICAL MOTION	—	U702
	INTERRUPTED MOTION*§	—	U703
	LIMITED MOTION*§	ISO 4	U704
	LIMITED MOTION AND RETURN*§	ISO 5	U705
	OSCILLATING MOTION, CONTINUOUS CYCLE*§	—	U706
	CONTINUOUS ROTATION TO RIGHT*§	DIN 100, ISO 7A	U707

Marking	Description	Std.	Suffix No.*§
	CONTINUOUS ROTATION TO LEFT	ISO 7B	U708
	INTERRUPTED ROTATION TO LEFT	—	U710
	INTERRUPTED ROTATION TO RIGHT	—	U711
	DIRECTION OF SPINDLE SPEED	—	U717
	FEED	ISO 16	U720
	REDUCED SPEED	—	U723
	RAPID FEED	—	U724
	NORMAL FEED	—	U725
	LONGITUDINAL FEED	—	U726
	TRANSVERSE FEED	—	U727
	RAPID TRANSVERSE	ISO 26	U728
	THREADING	—	U729
+	INCREASE	ISO 28	U730
-	DECREASE	ISO 29	U731
	CONVENTIONAL MILLING	—	U736
	CLIMB MILLING	—	U737
	ELECTRIC MOTOR	ISO 41	U800
	TURNING SPINDLE	—	U803
	DRILLING SPINDLE	—	U804
	MILLING SPINDLE	—	U805
	GRINDING SPINDLE	—	U806
	PUMP	ISO 48	U807
	COOLANT PUMP	—	U808
	LUBRICATION PUMP	—	U809
	HYDRAULIC SYSTEMS PUMP	—	U810
	HYDRAULIC MOTOR	—	U811
	TRACER	—	U812
	SHEAR PIN CONSTRUCTION	ISO 91	U850
	ATTENTION/DANGER	DIN 131, ISO 92	U851
	CAUTION	ISO 93	U852
	MAIN SWITCH	ISO 94	U853
	ACOUSTIC WARNING EQUIPMENT	DIN 155	U854
—	—	—	—

\* Items in grey shaded table cells only available on legend plates. Not available as laser-engraved text on button caps, illuminated push button diffusers, or pilot light diffusers.

\* Not available on -11 or -17 legend plates.

† Not available on -12, -18, or -20 legend plates.

§ Not available on -34 legend plates.

♣ Not available on -35 legend plates.

➤ Not available on -42 legend plates.

Standard Symbols, Continued

Marking	Description	Std.	Suffix No. *§
	SETUP	DIN 986	U855
	COOLANT FLUID	ISO 101	U875
	LIGHT	ISO 139, 102	U876
	WEIGHT	—	U877
	REFILLING	DIN 256, ISO 104	U878
	FULL LEVEL	—	U879
	DRAIN	DIN 257, ISO 106	U880
	OVERFLOW	DIN 258, ISO 105	U881
	OIL LUBRICATION	DIN 175, ISO 107	U882
	BLOWING UNIT	DIN 263, ISO 108	U883
	SUCTION UNIT	DIN 264, ISO 109	U884
	STEPLESS OPERATION	ISO 61	U900
	CLAMP OR TIGHTEN	ISO 63A	U901
	CLAMP OR TIGHTEN	—	U902
	LOOSEN	ISO 64A	U903
	LOOSEN	—	U904
	BRAKE ON	ISO 65	U905
	BRAKE RELEASE	ISO 66	U906
	AUTO CYCLE	—	U907
	MANUAL	DIN 35	U908
	START	ISO 69	U909
	STOP	ISO 70	U910
	TAKE ACTION WHEN CONTROL IS OPERATING	—	U912
	ENGAGE	DIN 46, ISO 74	U913
	DISENGAGE	DIN 45, ISO 75	U914
	ENGAGE TRACE	—	U917
	DISENGAGE TRACE	—	U918
	CHANGE SPEED ONLY IN STOPPED POSITION	—	U919
	CHANGE SPEED ONLY WHEN IN MOTION	—	U920
	CONTINUOUS ADJUSTMENT	ISO 62	U921
	AUTOMATIC OR SEMIAUTOMATIC CYCLE	DIN 267	U922
R	RESET	—	U924

\* Not available on -11 or -17 legend plates.

§ Not available on -34 legend plates.

Legend Texts, Continued

Standard Text\*

English

Marking	Suffix No.	Marking	Suffix No.	Marking	Suffix No.	Marking	Suffix No.	Marking	Suffix No.
(Blank)	E100	FOR-OFF-REV ▶	E261	LAST STOP	E278	PULL TO RESET	E176	START	E208
I-O-AUTO§♣▶	E235	FOR-REV ▶	E253	LEFT	E145	PUMP STOP	E290	START CYCLE	E209
ACCU-STOP ▶	E284	FOR-STOP-REV ▶	E254	LEFT-RIGHT ▶	E146	PURGE	E271	START-JOG ▶	E210
AT SPEED	E285	FORWARD	E120	LOCAL-REMOTE ▶	E147	PUSH TO STOP	E179	START-STOP ▶	E211
AUTO	E101	FORWARD-AUTO-REVERSE ▶	E121	LOW	E148	PUSH TO STOP-TWIST OR PULL, RELEASE※§▶	E262	STOP	E212
AUTO-O-HAND§♣▶	E250			LOW-HIGH ▶	E149			STOP-CYCLE ▶	E213
AUTO-HAND ▶	E102	FORWARD-OFF-REVERSE ▶	E122	LOW-OFF-HIGH ▶	E150	PUSH-TO-TEST	E181	STOP-RESET ▶	E214
AUTO-MAN-OFF ▶	E103			LOW SPEED	E151	RAISE	E182	STOP-START ▶	E215
AUTO-MANUAL ▶	E286	FORWARD-STOP-REVERSE ▶	E123	LOWER	E152	RAISE-LOWER ▶	E183	SUMMER-OFF-WINTER ▶	E216
AUTO-OFF-HAND ▶	E104			LOW-OFF-RAISE ▶	E153	RAISE-OFF-LOWER ▶	E184		
BLOWER	E268	FORWARD-REVERSE ▶	E124	LOWER-RAISE ▶	E154	READY	E185	SUMMER-WINTER ▶	E217
BRAKE	E105			MANUAL	E155	RESET	E186	SUPPLY ON	E218
BYPASS-OFF-DRIVE§♣▶	E297	FULL SPEED	E125	MAN-O-AUTO§♣▶	E238	RETURN	E187	TEST	E219
BYPASS ON§♣▶	E295	HAND	E126	MAN-AUTO ▶	E258	REV-FOR ▶	E260	TRANSFER ▶	E220
BYPASS START§♣▶	E299	HAND-I-AUTO§♣▶	E239	MANUAL-AUTO ▶	E156	REVERSE	E188	TRIP	E221
BYPASS STOP§♣▶	E298	HAND-O-AUTO ▶	E283	MAN-OFF-AUTO ▶	E259	REVERSE-FORWARD ▶	E189	UNCLAMP	E222
CLAMP	E106	HAND-AUTO ▶	E127	MANUAL-OFF-AUTO ▶	E157			UP	E223
CLOSE	E107	HAND-OFF-AUTO ▶	E128	MOTOR RUN	E158	REVERSE-OFF-FORWARD ▶	E190	UP-DOWN ▶	E224
CYCLE START	E108	HAND OFF	E264	MOTOR RUNNING	E159			UP-OFF-DOWN ▶	E225
DECREASE ▶	E109	HAND ON	E263	MOTOR START	E160	RIGHT	E191		
DRIVE-START ▶	E287	HAND START	E265	MOTOR STOP	E161	RIGHT-LEFT ▶	E192		
DRIVE-STOP ▶	E288	HAND STOP	E266	MOTOR STOPPED	E162	ROTATE CW	E246		
DOWN	E110	HEAT	E270	NO FLIP	E275	ROTATE CCW	E247		
DOWN-OFF-UP ▶	E111	HIGH	E129	OFF	E163	RUN	E193		
DRIVE ON§♣▶	E296	HIGH-LOW ▶	E130	OFF CIRCUIT	E244	RUN-JOG ▶	E194		
EMERG STOP	E251	HIGH-OFF-LOW ▶	E131	OFF-COOLANT-ON ▶	E164	RUN-SAFE-JOG ▶	E195		
EMERGENCY ▶	E248	IN	E132	OFF-LIGHT-ON ▶	E272	RUNNING	E243		
EMERGENCY OFF ▶	E294	IN-OUT ▶	E133	OFF-ON ▶	E165	SAFE	E196		
EMERGENCY STOP ▶	E112	INCH	E134	ON	E166	SAFE-RUN ▶	E197		
ENABLE	E279	INCH-REV ▶	E257	ON CIRCUIT	E245	SETUP	E198		
ENTER	E277	INCH-REVERSE ▶	E135	ON-OFF ▶	E167	SETUP-RUN ▶	E302		
ERROR	E273	INCH-RUN ▶	E136	ON-OFF-AUTO ▶	E168	SETUP-SERVICE ▶	E199		
EXHAUSTER ▶	E269	INCREASE ▶	E137	ON-STOP-SAFE ▶	E169	SEQUENCE-TEST ▶	E200		
FAULT	E113	INSPECT	E274	OPEN	E170	SLOW	E201		
FAST	E114	JOG	E138	OPEN-CLOSE ▶	E171	SLOWER	E202		
FAST-OFF-SLOW ▶	E289	JOG-FOR ▶	E255	OPEN-OFF-CLOSE ▶	E172	SLOWEST	E203		
FASTER	E115	JOG-FORWARD ▶	E139	OUT	E173	SLOW-FAST ▶	E204		
FEED START	E116	JOG-OFF-RUN ▶	E140	OVERLOAD ▶	E267	SLOW-OFF-FAST ▶	E205		
FEED STOP	E117	JOG-REV ▶	E256	OVERLOAD TRIP ▶	E174	SLOW-STOP-FAST ▶	E206		
FEEDER OFF	E118	JOG-REVERSE ▶	E141	OVERLOAD RESET ▶	E175	SLOW-OFF-START ▶	E207		
FEEDER ON	E119	JOG-RUN ▶	E142	POWER OFF	E177	SLOW SPEED	E291		
FIFO	E276	JOG-SAFE-RUN ▶	E143	POWER ON	E178	SOFT STOP	E292		
FOR-AUTO-REV ▶	E252	JOG-STOP-RUN ▶	E144	PULL TO START	E180	SPEED	E293		

\* Items in grey shaded table cells only available on legend plates. Not available as laser-engraved text on button caps, illuminated push button diffusers, or pilot light diffusers.

※ Not available on -11 or -17 legend plates.

§ Not available on -34 legend plates.

♣ Not available on -35 legend plates.

▶ Not available on -42 legend plates.



Legend Texts, Continued  
Standard Text, Continued\*  
French

Marking	Suffix No.	Marking	Suffix No.	Marking	Suffix No.	Marking	Suffix No.	Marking	Suffix No.
A-COUPS	F138	AVANT-ARRÊT-ARRIÈRE	F122	DESCENDRE	F110	HORS MANUEL	F249	MARCHE-ARRÊT	F211
ACCU-STOP	F280			DROIT	F191	LENT	F201	MONTER	F182
ARRIÈRE	F188	AVANT-ARRIÈRE	F124	EN	F247	LENT-ARRÊT-VITE	F205	OUVRIR	F170
ARRÊT	F163	AV-ARR	F290	EN CIRCUIT	F245	M FORCEE	F284	PANNE	F113
ARRÊT D'ENTR	F289	AV-HORS-ARR	F253	EN MANUEL	F250	MANUEL	F126	RAP-HORS-LENT	F285
ARRÊT DOUX	F288	BAS	F148	FERMER	F107	MANUEL-ARRÊT-AUTO	F128	RAPIDE	F114
ARRÊT D'URGENCE	F112	BAS-ARRÊT-HAUT	F150	FREINAGE	F105			RÉGLER	F198
ARRÊT-MANUEL	F251	DEMAR. D-ENTR	F283	GAUCHE	F145	MANUEL-AUTO	F127	SURCHARGE	F254
ARRÊT-MARCHE	F165	DEMAR.-MAN.	F252	HAUT	F129	MANUEL-HORS-AUTO	F157	VARIATEUR ALIMENTÉS	F293
ARRÊT POMPE	F286	DÉRIV-ARRÊT-EFN	F294	HAUT-HORS-BAS	F131			VIT. ATTEINT	F281
AUTO	F101	DÉRIV ARRÊT	F295	HORS	F246	MARCHE	F166	VIT. LENTE	F287
AUTO-MANUEL	F282	DÉRIV MARCHE	F296	HORS CIRCUIT	F244	—	—	VITESSE	F291
AVANT	F120	DÉRIVATION ALIMENTÉS	F292	HORS-EN	F248	—	—	—	—

Spanish

Marking	Suffix No.	Marking	Suffix No.	Marking	Suffix No.	Marking	Suffix No.	Marking	Suffix No.
ABRIR	S170	ARRANQUE	S166	DERECHA	S191	MARCHA	S208	PARADA-MARCHA	S165
ADELANTE	S120	ATRÁS	S188	EN SERVICIO	S243	MARCHA-PARO	S211	PARO	S163
ADELANTE-ATRÁS	S124	BAJADA	S152	IZQUIERDA	S145	PARADA	S212	SUBIDA	S182
ADELANTE-PARADA-ATRÁS	S123	BAJAR	S110	MANUAL	S126	PARADA DE EMERGENCIA	S112	SUBIR	S223
		CERRAR	S107	MANUAL-AUTO	S127			—	—

German

Marking	Suffix No.	Marking	Suffix No.	Marking	Suffix No.	Marking	Suffix No.	Marking	Suffix No.
AB	G110	EINRICHTEN	G198	LANGSAM	G201	ÖFFNEN	G170	VOR	G120
AUF	G223	HAND	G126	LINKS	G145	RECHTS	G191	VOR-AUS-ZURÜCK	G122
AUS	G163	HAND-AUS-AUTO	G128	LINKS-RECHTS	G146	SCHNELL	G114	VOR-ZURÜCK	G124
AUS-EIN	G165	HAND-AUTO	G127	NIEDRIG	G148	SENKEN	G152	ZU	G107
BETRIEB	G243	HEBEN	G182	NIEDRIG-AUS-HOCH	G150	STÖRUNG	G113	ZURÜCK	G188
EIN	G166	HOCH	G129	NOT AUS	G112	—	—	—	—

Italian

Marking	Suffix No.	Marking	Suffix No.	Marking	Suffix No.	Marking	Suffix No.	Marking	Suffix No.
ABBASSARE	T152	AVANTI-DISINS-INDIETRO	T122	DISCESA	T110	IN SERVIZIO	T243	MARCIA-ARRESTO	T211
ALTO	T129			DISINS-INS	T165	LENTO	T201	PREPARARE	T198
APRIRE	T223	AVANTI-INDIETRO	T124	DISINSERITO	T163	MANUALE	T126	RAPIDO	T114
ARRESTO	T212	BASSO	T148	DISTURBO	T113	MANUALE-AUTO	T127	ROTAZIONE CW	T246
ARRESTO EMERGENZA	T112	BASSO-DISINS-ALTO	T150	EMERGENZA	T248	MANUALE-DISINS-AUTO	T128	ROTAZIONE CCW	T247
		DESTRA	T191	INDIETRO	T188			SALITA	T182
AUTOMATICO	T101	CHIUDERE	T107	INSERITO	T166	MARCIA	T208	SINISTRA	T145
AVANTI	T120	—	—	—	—	—	—	—	—

Swedish

Marking	Suffix No.	Marking	Suffix No.	Marking	Suffix No.	Marking	Suffix No.	Marking	Suffix No.
BACK	N188	HÖGER	N191	NERN	110	UPP	N223	VÄNSTER	N145
FRAM	N120	—	—	—	—	—	—	—	—

\* Items in grey shaded table cells only available on legend plates. Not available as laser-engraved text on button caps, illuminated push button diffusers, or pilot light diffusers.

§ Not available on -34 legend plates.

‡ Not available on -35 legend plates.

➤ Not available on -42 legend plates.

‡ Only available on legend plates and AD2 or AD4 diffusers.



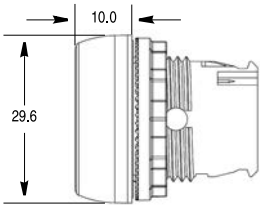
# 22.5 mm Push Buttons

## Approximate Dimensions

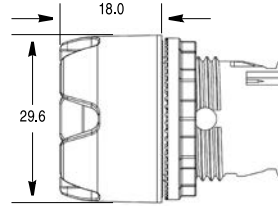
### Approximate Dimensions

Dimensions in millimeters. Dimensions are not intended to be used for manufacturing purposes. Refer to RAISE software for additional dimensional information.

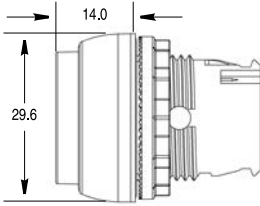
#### Non-Illuminated and Illuminated Momentary Flush Push Button Operators



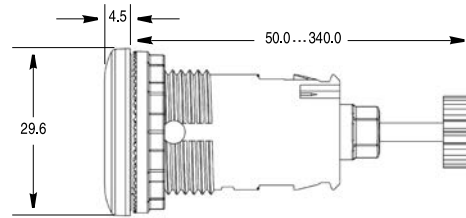
#### Illuminated Momentary Guarded Push Button Operators



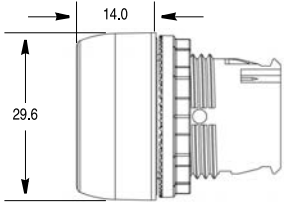
#### Illuminated and Non-Illuminated Momentary Extended Push Button Operators



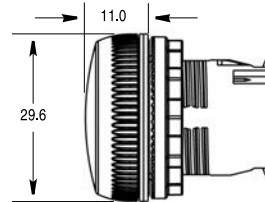
#### Reset Operators with Reset Rod



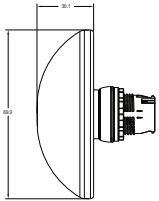
#### Non-Illuminated Guarded, Illuminated and Non-Illuminated Alternate Action Push Button Operators



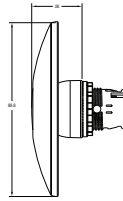
#### Pilot Light Operators



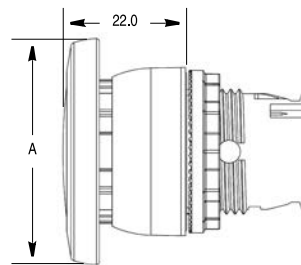
#### 90 mm Half Dome



#### 90 mm Mushroom

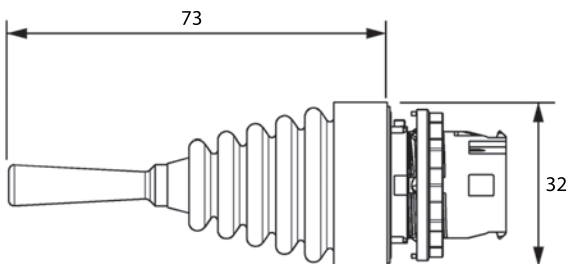


#### Illuminated and Non-Illuminated Momentary Mushroom Operators 40 mm and 60 mm

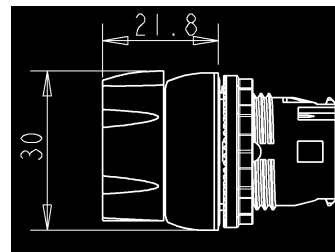


Operator	A
40 mm	39.8
60 mm	59.8

#### Toggle Switch Operators

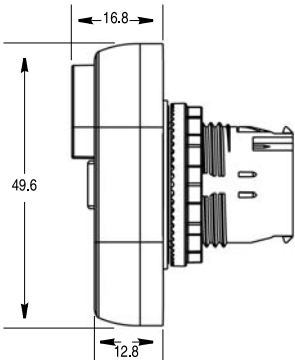


#### Selector Jog Operators

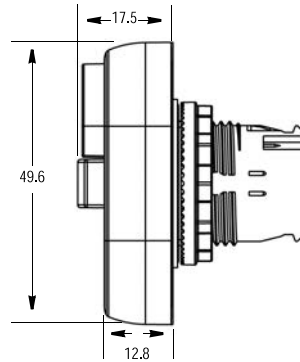


Dimensions in millimeters. Dimensions are not intended to be used for manufacturing purposes.

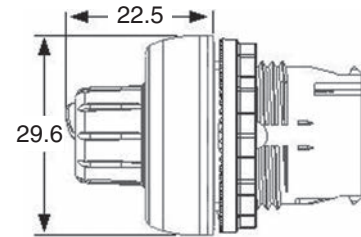
**Illuminated and Non-Illuminated 2-Position Multi-Function Operators**



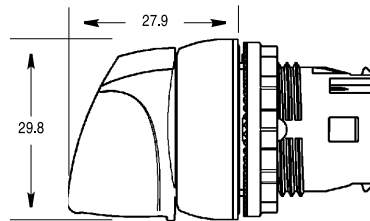
**Non-Illuminated 3-Position Multi-Function Operators**



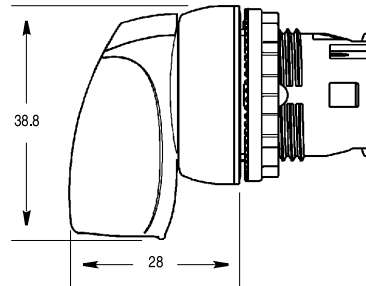
**Potentiometer Operator**



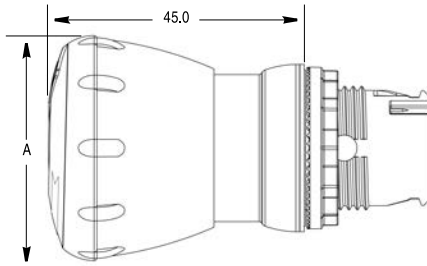
**Illuminated and Non-Illuminated Knob Selector Switch Operators**



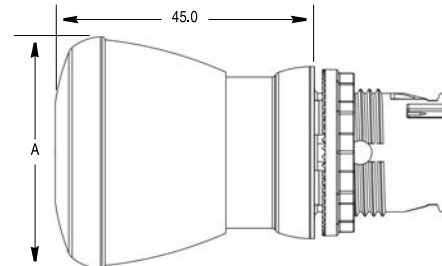
**Non-Illuminated Knob Lever Selector Switch Operators**



**Illuminated and Non-Illuminated Twist-to-Release Operators 30 mm, 40 mm, and 60 mm**

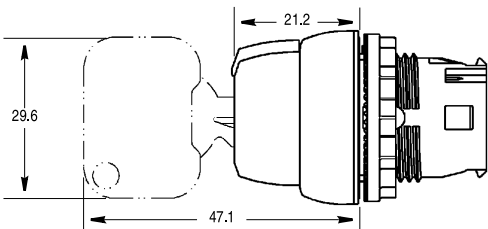


**Illuminated and Non-Illuminated Push-Pull Mushroom Operators 30 mm, 40 mm, and 60 mm**

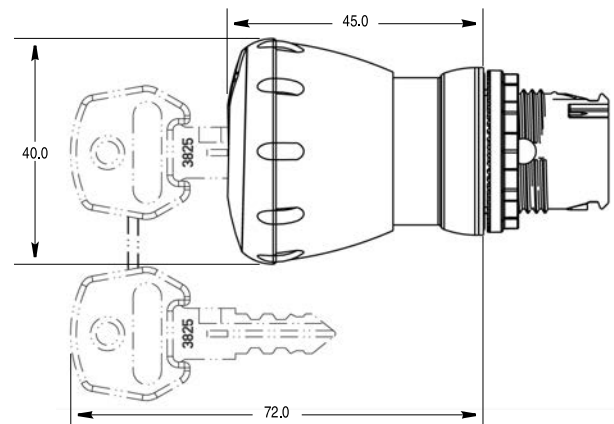


Operator	A
30 mm	30.0
40 mm	40.0
60 mm	60.0

**Key Selector Switch and Key Ejected SensEject Operators**



**Mushroom Key Release Operator 40 mm**

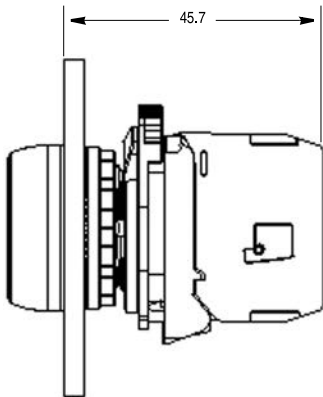


# 22.5 mm Push Buttons

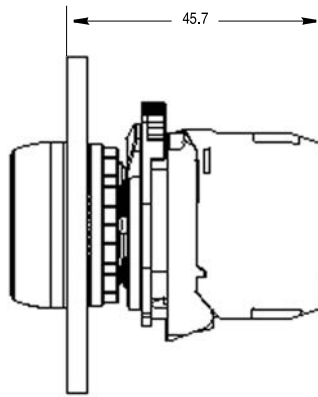
## Approximate Dimensions

Dimensions in millimeters. Dimensions are not intended to be used for manufacturing purposes.

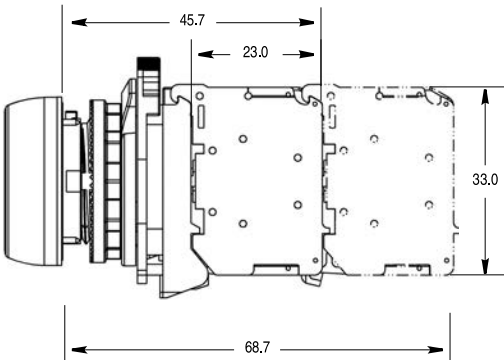
**Back-of-Panel Components —  
Incandescent Module with Latch**



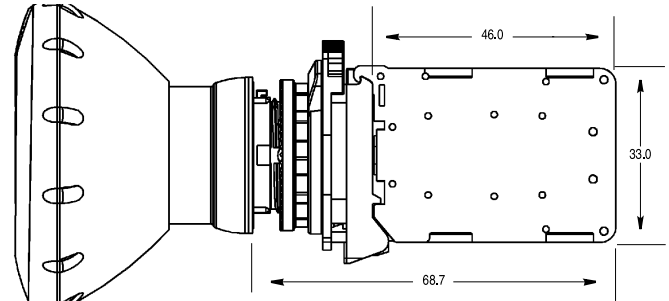
**Back-of-Panel Components —  
LED Module with Latch**



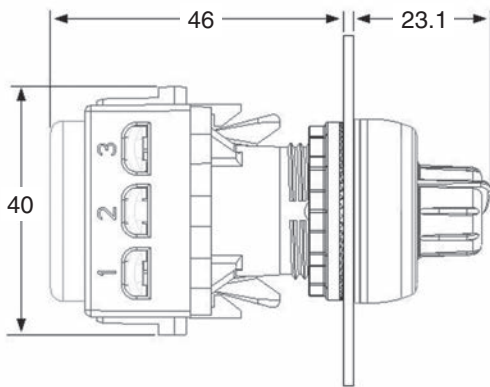
**Back-of-Panel Components —  
Contact Cartridges with Latch**



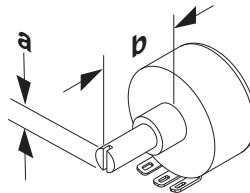
**Back-of-Panel Components —  
Dual Circuit Contact Block or  
Self Monitoring Contact Block  
(Max. of 1 Deep)**



**Potentiometer with Resistive Element**



**Customer Supplied Resistive Element**

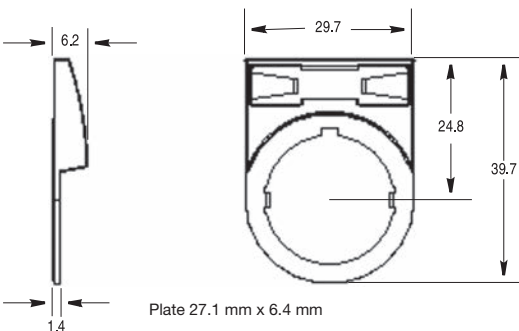


	Max.		Min.
a (Ø Dia.)	6.4 (0.252)	5.9 (0.232)	5.7 (0.224)
b (Length)	24 (0.945)	32 (1.26)	14 (0.551)

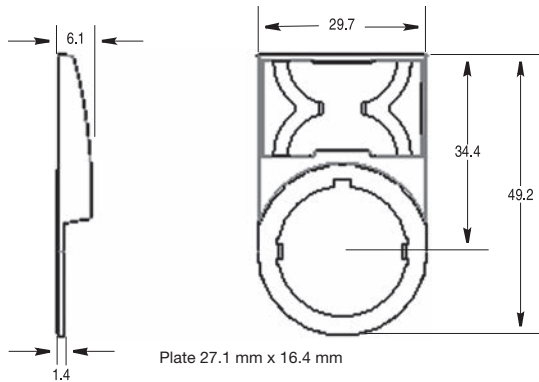
Dimensions in millimeters (inches).

10

**30 x 40 mm Snap-In Legend Plate**

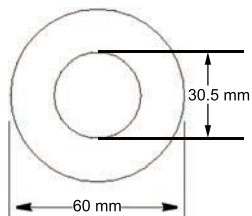


**30 x 50 mm Snap-In Legend Plate**

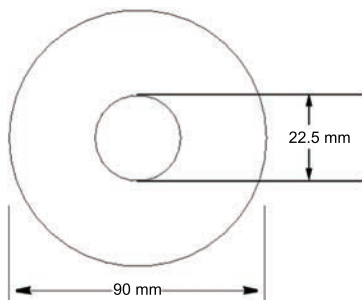


Dimensions in millimeters. Dimensions are not intended to be used for manufacturing purposes.

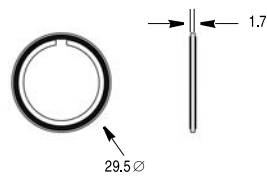
**60 mm Round Legend — 15Y**



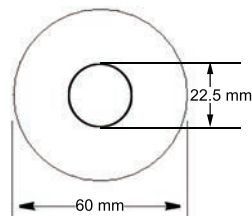
**90 mm Round Legend**



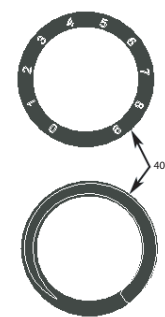
**Trim Washer**



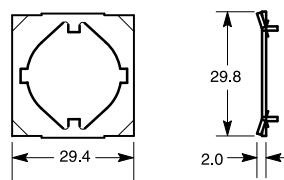
**60 mm Round Legend — 15YS**



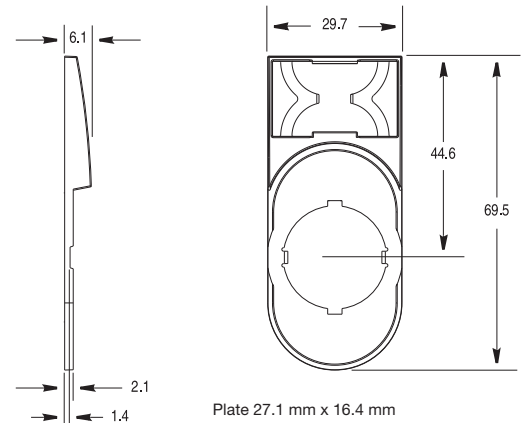
**Potentiometer Legend Plate (Series A)**



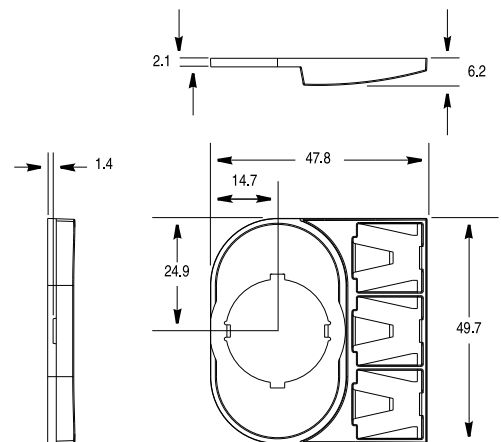
**Anti-Rotation Washer**



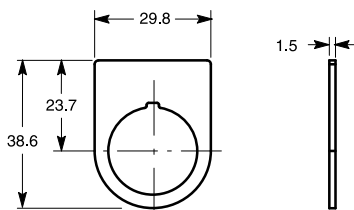
**30 x 60 mm Snap-In Legend Plate**



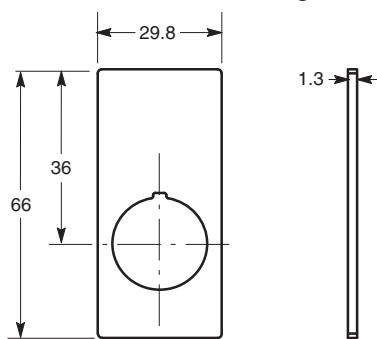
**Special Multi-Function Snap-In Legend Plate**



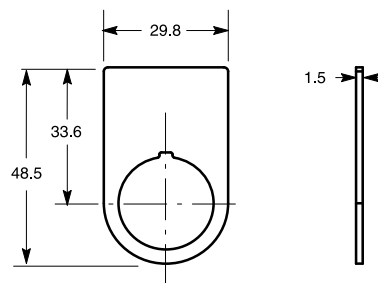
**30 x 40 mm One-Piece Legend Plate**



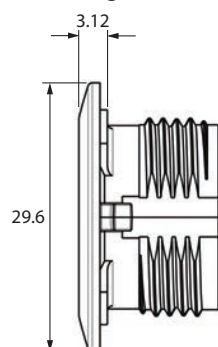
**30 x 66 mm One-Piece Legend Plate**



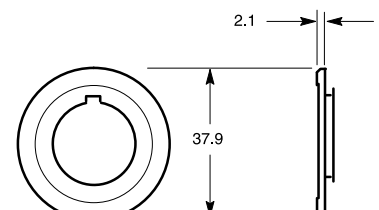
**30 x 50 mm One-Piece Legend Plate**



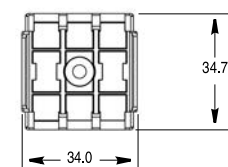
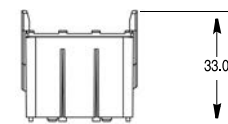
**Hole Plug**



**30 mm to 22.5 mm Hole Adapter**



**Base Mount Adapter**



Note: Panel thickness range is 1.0...6.0 mm maximum.

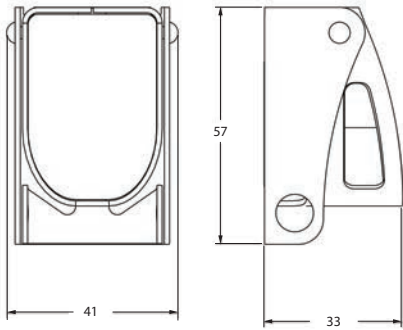
Panel thickness reduced to 4 mm (standard anti-rotation washer) or 5 mm (thin anti-rotation washer) when optional legend plates are used.

# 22.5 mm Push Buttons

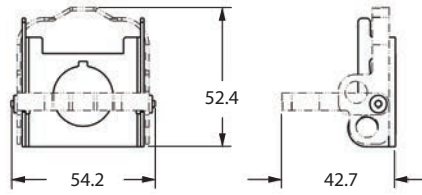
## Approximate Dimensions

Dimensions in millimeters. Dimensions are not intended to be used for manufacturing purposes.

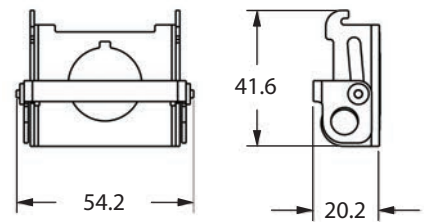
**Locking Cover**



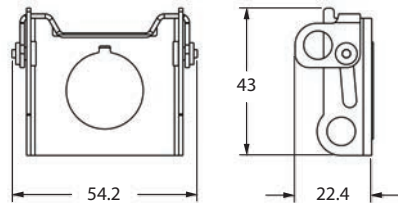
**Maintained Mushroom Locking Attachment**



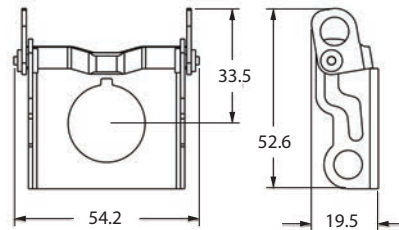
**Momentary Mushroom Locking Attachment**



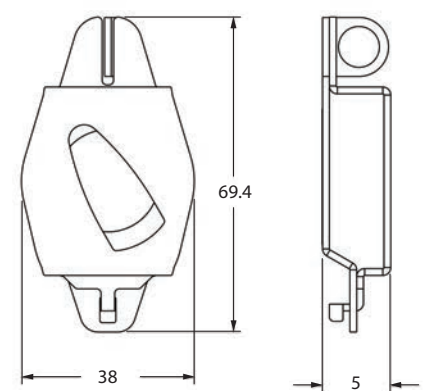
**Extended Non-Illuminated Locking Attachment**



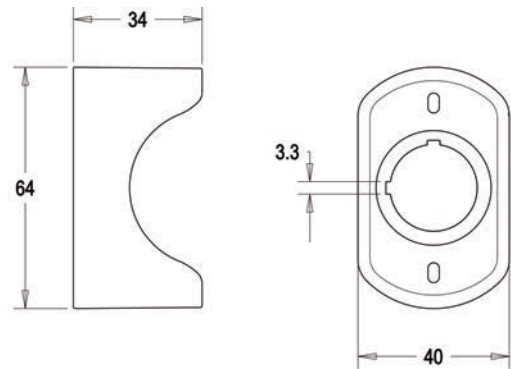
**Flush Non-Illuminated Locking Attachment**



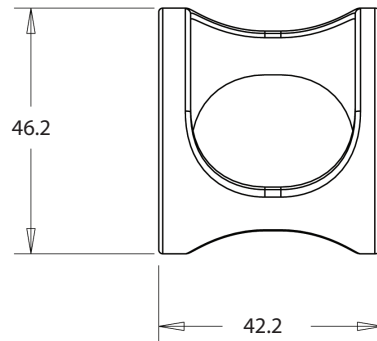
**Selector Switch Locking Cover  
(Same for all Lock Positions)**



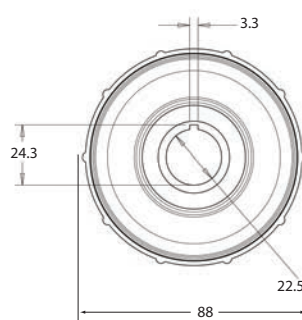
**Narrow Guard**



**Protective Ring**

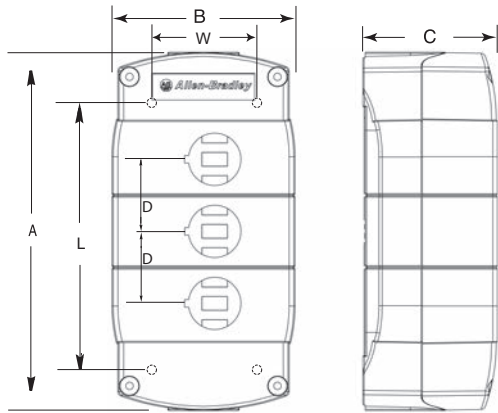


**Plastic Guard**



Dimensions in millimeters. Dimensions are not intended to be used for manufacturing purposes.

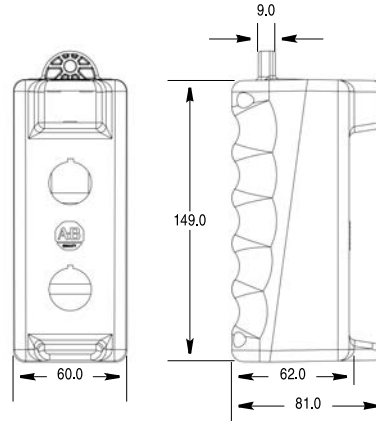
**Plastic Enclosures\***



Cat. No.	No. of Holes	A	B	C	D	Mounting Holes	
						W	L
800F-1P*	1	85	89	58	—	58	59
800F-1Y*D		85	89	74	—	58	65
800F-2P*	2	124	79	58	31	48	102.5
800F-3P*	3	155	79	58	31	48	133
800F-4P*	4	186	79	58	31	48	164.5
800F-6P*	6	248	87	64	31	55	224

\* Mounting screw — pan head with diameter ≤ 7 mm.

**Pendant Stations**



**Note:** Cable opening = 21.2 mm diameter

**Instruction Sheet**

OPTIONAL EN OPTION  
 OPTIONAL PLASTIQUE  
 OPCIONAL  
 OPZIONALE

(A)								
(A)								
(B)								
	40	50	40	50	40/60	50/60	60/90	70
	30	48	40/60		60/90		30	50

1- 4,8 mm  
 "Clic"  
 "Clic"  
 1- 2,8 mm  
 "Clic"  
 "Clic"  
 1- 6 mm  
 1- 4 mm

7 mm  
 0,75 - 1,5 mm<sup>2</sup>  
 (#18 - #14 AWG)

0,6 mm  
 3,5 mm  
 8 mm

0,75 - 2,5 mm<sup>2</sup>  
 (#18 - #12 AWG)

0,7 - 0,9 Nm  
 6 - 8 lb-in

1,2 Nm  
 10 lb-in

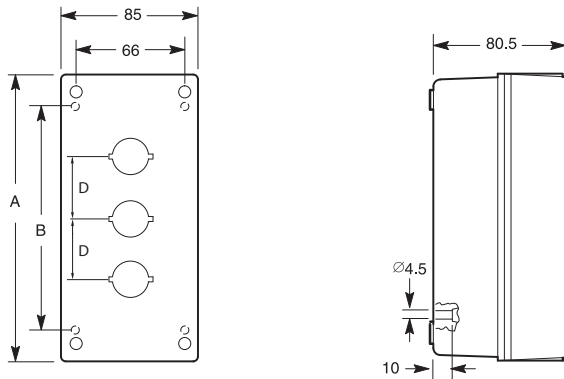
PLASTIC  
 PLASTIK  
 PLÁSTICO  
 PLÁSTICA

1,7 Nm  
 15 lb-in

METAL  
 METALL  
 METÁL  
 METALLO

4,4 Nm  
 40 lb-in

**Metal Enclosures**



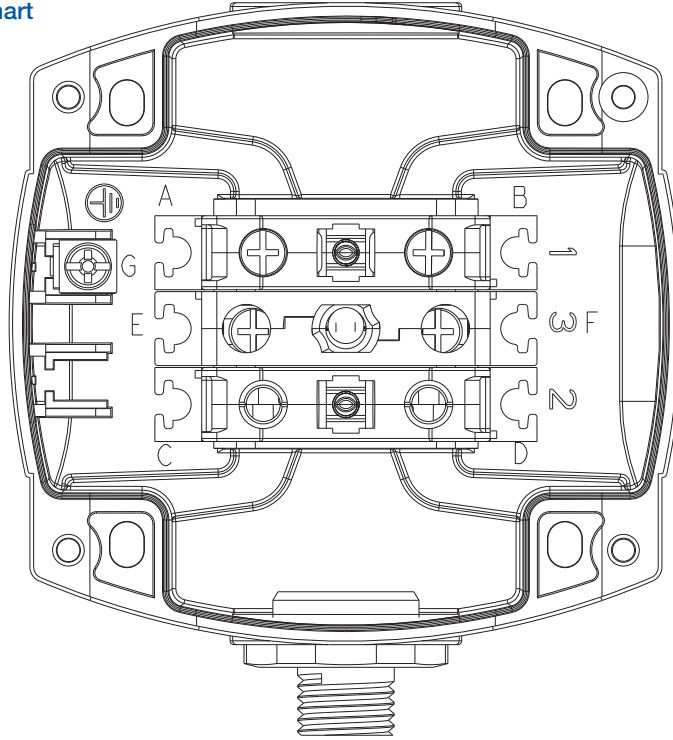
Cat. No.	No. of Units (Holes)	A	B	D
800F-1M*	1	99	62	—
800F-2M*	2	137	100	37.5
800F-3M*	3	174	137	37.5
800F-5M*	5	249	212	37.5

\* P = PG conduit holes or M = Metric conduit holes

# 22.5 mm Push Buttons

Approximate Dimensions

## Assembled Station Pin Out Chart



Cat. No.	Connector Style / No. of Pins	Location 1	A to Pin #	B to Pin #	Location 2	C to Pin #	D to Pin #	Location 3	E to Pin #	F to Pin #	G to Pin #
800F-1YMQ53V	AC Micro / 5-pin	BX01V	1	2	BX01V	4	5	—	—	—	3
800F-1YMQA	AC Micro / 6-pin	BX01	1	5	BX01	2	6	BX10	3	4	—
800F-NX1	DC Micro / 4-pin	BX01	1/4	2/3	—	—	—	—	—	—	—
800F-1YMQ1		BX01	1/4	2/3	—	—	—	—	—	—	—
800F-1YMQ2		BX10V	2	4	BX01V	1	3	—	—	—	—
800F-1YMQ3		BX01V	1	3	BX01V	2	4	—	—	—	—
800F-1YMQ3VEG		BX01V	1	3	BX01V	2	4	—	—	—	—
800F-1YMQ3V		DC Micro / 5-pin	BX01V	1	2	BX01V	4	5	—	—	—
800F-1YMQ41	Mini Receptacle / 4-pin	BX01	2	4	—	—	—	—	—	—	—
800F-1YMQ44		BX10	1	J	BX01	2	4	BN3R	3	J	J
800F-1YMQ4	Mini Receptacle / 6-pin	BX10	1	J	BX01	6	5	BN3R	2	J	J
800F-1YMQ5		BX10	1	J	BX01	6	5	BN5R	2	J	J
800F-1YMQ6		BX10	1	J	BX01	6	5	BN7R	2	J	J
800F-1MYMQ4		BX10	1	J	BX01	6	5	BN3R	2	J	J
800F-1MYMQ5		BX10	1	J	BX01	6	5	BN5R	2	J	J
800F-1MYMQ6		BX10	1	J	BX01	6	5	BN7R	2	J	J

J = Jumper





### Bulletin 800FC — Configured Pendant Stations

- 3-, 5-, 7-, and 9-button configurations
- 1-, 2-, and 3-speed push buttons
- IP66, NEMA Type 4/4X/13
- Finger-safe contact blocks
- Buttons are flush-mounted with the enclosure to reduce accidental operation
- Use of standard Bul. 800F extended push buttons
- Electrical and mechanical interlocks

### Bulletin 800FP — 1-, 2-, and 3-Speed Operators

- IP65/IP66, NEMA Type 4/4X/13
- Engineering grade thermoplastics
- Chemical-resistant for harsh environments
- Booted operator

### Mechanical Interlock

- 1-, 2-, and 3-speed operators
- Screw-down mounting
- 3-across x 1 deep contact blocks
- Snap-down contact blocks
- Bifurcated and Quad Connect contact blocks
- Color-coded contact blocks

### Table of Contents

Product Selection ..... 10-128  
 Catalog Number  
 Explanation ..... 10-132  
 Accessories..... 10-134  
 Specifications..... 10-136  
 Approximate Dimensions \* ..... 10-138

### Product Certifications

Certifications	UR/UL, CSA, CCC, CE
Standards Compliance	NEMA ICS-5, UL 508, CSA C22.2 No. 14, EN ISO 13850, EN 60947-1, EN 60947-5-1, EN 60947-5-5
Terminal Identification	EN/IEC 60947-1
RoHS	✓

### Operator Mounting - Vertical vs. Horizontal Definition

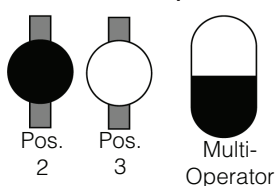
Due to the design of the enclosures, operators are mounted in both a vertical and horizontal orientation. The easiest way to visualize the operator orientation is by observing the contact block direction attached to the operators. If the contact blocks are mounted vertically the operator is mounted vertically in the enclosure. Vertical mounted operators are only found in position 2 & 3 of the 3-hole enclosure. If the contact blocks are mounted horizontally the operator is mounted horizontally in the enclosure. Horizontal mounted operators are found in position 1 of the 3-hole enclosure and all positions of the 5-...9-hole enclosures. It is necessary to know this when ordering individual operators for populating at the customer location.

### Operator Sequence when using a Mechanical Interlock

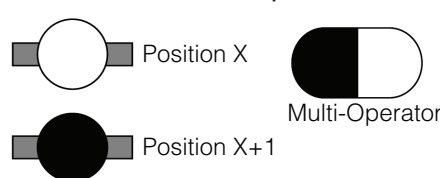
The 1-, 2-, and 3-speed operators can be mounted with either our standard **Cat. No. 800F-ALP** latch or a mechanical interlocking latch (**Cat. No. 800FC-ALP**). For the 3-hole enclosure, the mechanical interlock can only be located in positions 2 & 3, with the black operator being located in position 2 and the white operator being located in position 3. For the 5-...9-hole enclosures, the mechanical interlock can be located in any two adjacent positions. For the 5-...9-hole enclosures, the white operator will be located in position X of the mechanical interlock and the black operator will be located in position X+1 of the mechanical interlock.

### Operator Assembly Sequence and Mounting Orientation

#### Vertical Mount Operators



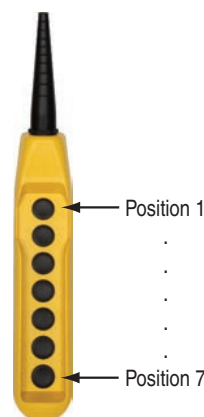
#### Horizontal Mount Operators



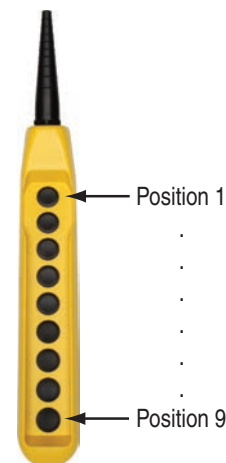
3-Hole Enclosure\*



5-Hole Enclosure\*



7-Hole Enclosure\*



9-Hole Enclosure\*

\* Operator in Position 1 is mounted horizontal, contact blocks are horizontal. Operators in Positions 2 & 3 are mounted vertical, contact blocks are vertical.  
 \* Operators in all positions are mounted horizontal, contact blocks are horizontal.

Bulletin 800FC  
**22.5 mm Configured Pendant Stations**  
 Product Selection

Product Selection  
 Enclosures

Enclosure Type	Pkg. Quantity	Pendants — Yellow Plastic IP66 Cat. No.*
3-hole	1	800FC-3Z
5-hole		800FC-5Z
7-hole		800FC-7Z
9-hole		800FC-9Z

\* Housings supplied with cable sleeve, hanger ring, cable clamp, wire guides, and gasket.



Cat. No. 800FC-3Z



Cat. No. 800FC-7Z

1-, 2-, and 3-Speed Operators §\*

800FP - C  $\frac{A}{a}$   $\frac{1}{b}$   $\frac{U243}{c}$



**a**

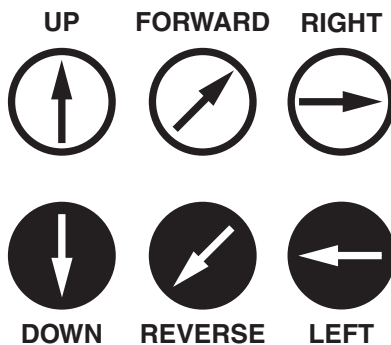
Operator Type	
Code	Description
A	1-speed single arrow
D	1-speed double arrow
B	2-speed
C	3-speed*

\* Proper contact block assembly of these devices is required. Please see contact block information on page 104.

**b**

Cap Color	
Code	Description
1	White
2	Black

Arrow Direction Chart



**c**

Symbol	Code	Valid with Table a Selections:	Description†			
			Vertical Mounting		Horizontal Mounting	
			Black with White Arrow	White with Black Arrow	White with Black Arrow	Black with White Arrow
	U100	A, B, C	Blank	Blank	Blank	Blank
One-Speed Operators						
	U241	A	DOWN	UP	—	—
	U243		—	—	RIGHT	LEFT
	U244		REVERSE	FORWARD	—	—
	U246		—	—	FORWARD	REVERSE
	U700		LEFT	RIGHT	UP	DOWN
	U261	D	DOWN FAST	UP FAST	—	—
	U263		—	—	RIGHT FAST	LEFT FAST
	U264		REVERSE FAST	FORWARD FAST	—	—
	U266		—	—	FORWARD FAST	REVERSE FAST
	U260		LEFT FAST	RIGHT FAST	UP FAST	DOWN FAST
Two-Speed Operators						
	U271	B	2-speed DOWN	2-speed UP	—	—
	U273		—	—	2-speed RIGHT	2-speed LEFT
	U274		2-speed REVERSE	2-speed FORWARD	—	—
	U276		—	—	2-speed FORWARD	2-speed REVERSE
	U270		2-speed LEFT	2-speed RIGHT	2-speed UP	2-speed DOWN
Three-Speed Operators						
	U291	C	3-speed DOWN	3-speed UP	—	—
	U293		—	—	3-speed RIGHT	3-speed LEFT
	U294		3-speed REVERSE	3-speed FORWARD	—	—
	U296		—	—	3-speed FORWARD	3-speed REVERSE
	U290		3-speed LEFT	3-speed RIGHT	3-speed UP	3-speed DOWN

**Note:** Please see page 104 for proper latch and contact block configurations.

† Text (DOWN, UP, LEFT, etc.) indicates arrow direction. Text is **not** printed on operators.

§ Cat. No. 800F-ALP (standard latch) and Cat. No. 800FC-ALP (mechanical interlock latch) can be used with these operators.

\* Booted style of operators for pendant stations.

## Bul. 800F Two-Position Twist-to-Release and Twist-to-Release/Push-Pull Operators



Description	Operator Cat. No.	Guard Cat. No.
Twist-to-release — Red	<b>800FP-MT44PX01</b>	—
Twist-to-release — Red, illuminated	800FP-LMT44PN§RX01	—
Keyed twist-to-release — Red	800FP-MK44PX01	—
Twist-to-release or push-pull — Red, monolithic	<b>800FD-MT44X01</b>	—
Twist-to-release or push-pull — Red, monolithic with guard, monolithic	<b>800FD-MT44X01</b>	<b>800F-AMEGY</b>

§ Select **3** for 24V AC/DC or **5** for 120V AC.

## Bul. 800F Push Button Operators and Caps — Extended &amp; Non-Illuminated \*



Cap Color	Description	Symbol Definition	Operator Cat. No.	Cap Cat. No.	Complete Operator Cat. No.	Composite Cat. No./ No Electrical Interlock*	Composite Cat. No./ Electrical Interlock*
Black	Blank	—	<b>800FP-E2</b>	—	—	800FP-E2PX10	800FP-E2PX11
	LEFT or DOWN	Single arrow 0°	<b>800FP-E9</b>	<b>800F-AE208</b>	800FP-E208	800FP-E208PX10	<b>800FP-E208PX11</b>
	REVERSE	Single arrow 45°		<b>800F-AE2CU244</b>	<b>800FP-E2U244</b>	800FP-E2U244PX10	800FP-E2U244PX11
	LEFT FAST or DOWN FAST	Double arrow 0°		<b>800F-AE2CU261</b>	800FP-E2U261	800FP-E2U261PX10	800FP-E2U261PX11
REVERSE FAST	Double arrow 45°	800F-AE2CU264	800FP-E2U264	800FP-E2U264PX10	800FP-E2U264PX11		
White	Blank	—	<b>800FP-E1</b>	—	—	800FP-E1PX10	800FP-E1PX11
	UP or RIGHT	Single arrow 0°	<b>800FP-E9</b>	<b>800F-AE108</b>	800FP-E108	800FP-E108PX10	<b>800FP-E108PX11</b>
	FORWARD	Single arrow 45°		<b>800F-AE1CU244</b>	<b>800FP-E1U244</b>	800FP-E1U244PX10	800FP-E1U244PX11
	UP FAST or RIGHT FAST	Double arrow 0°		<b>800F-AE1CU261</b>	800FP-E1U261	800FP-E1U261PX10	800FP-E1U261PX11
FORWARD FAST	Double arrow 45°	800F-AE1CU264	800FP-E1U264	800FP-E1U264PX10	800FP-E1U264PX11		
Green	Blank	—	<b>800FP-E3</b>	—	—	800FP-E3PX10	—
	START/ALARM	Start/Alarm	<b>800FP-E9</b>	<b>800F-AE3CU222</b>	800FP-E3U222	800FP-E3U222PX10	
START	Start symbol	800F-AE3CU909		<b>800FP-E3U909</b>	800FP-E3U909PX10		
Red	Blank	—	<b>800FP-E4</b>	—	—	800FP-E4PX10	
	STOP	Stop symbol	<b>800FP-E9</b>	<b>800F-AE405</b>	<b>800FP-E405</b>	800FP-E405PX10	
Yellow	Blank	—	<b>800FP-E5</b>	—	—	800FP-E5PX10	
	ALARM	Alarm	<b>800FP-E9</b>	800F-AE5CU223	800FP-E5U223	800FP-E5U223PX10	
Blue	Blank	—	<b>800FP-E6</b>	—	—	<b>800FP-E6PX10</b>	
	R	Reset symbol	<b>800FP-E9</b>	<b>800F-AE611</b>	800FP-E611	800FP-E611PX10	

\* For 24V AC/DC units, add **V** for low voltage contact blocks. Example: **Cat. No. 800FP-E5PX10** becomes **Cat. No. 800FP-E5PX10V**.

\* Mechanical interlock is not allowed.

## Bul. 800F Push Button Operators — Extended &amp; Illuminated \*



Lens Color	Operator Cat. No.	Composite Cat. No.
Green	<b>800FP-LE3</b>	800FP-LE3PN§GX10
Red	<b>800FP-LE4</b>	800FP-LE4PN§RX10
Yellow	<b>800FP-LE5</b>	800FP-LE5PN§WX10
Blue	<b>800FP-LE6</b>	800FP-LE6PN§BX10
Clear	<b>800FP-LE7</b>	800FP-LE7PN§WX10

§ Select **3** for 24V AC/DC or **5** for 120V AC.

\* Mechanical interlock is not allowed.

## Bul. 800F Selector Switch Operators — Maintained &amp; Non-Illuminated

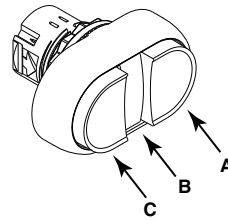
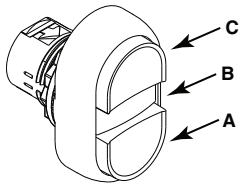


Number of Positions	Keyed	Operator Cat. No.	Composite Cat. No.*
	2	No	<b>800FP-SM22</b>
Yes		<b>800FP-KM21</b>	800FP-KM21PX11
3	No	<b>800FP-SM32</b>	<b>800FP-SM32PX20</b>
	Yes	<b>800FP-KM34</b>	800FP-KM34PX20

\* For 24V AC/DC units, add **V** for low voltage contact blocks. Example: **Cat. No. 800FP-E5PX10** becomes **Cat. No. 800FP-E5PX10V**.

Bulletin 800FC  
**22.5 mm Configured Pendant Stations**  
 Product Selection

**Bul. 800F Multi Operators and Caps— Extended ‡\***



*Vertical Mounting*

*Horizontal Mounting*

Description	Symbol Definition	Illumination	Operator Cat. No.	Position A Cap Cat. No.	Position C Cap Cat. No.	Back of Panel Cat. No.*
Blank (black and white cap)	—	Non-Illuminated	<b>800FP-U2X</b>	<b>800F-AEU2</b>	<b>800F-AEU1</b>	<b>800F-PX20</b>
		Illuminated	<b>800FP-LU2X</b>			800F-PN§WX20
<b>Vertical Mounting</b>						
UP (white)/DOWN (black)	Single arrow 0°	Non-Illuminated	<b>800FP-U2X</b>	<b>800F-AECU2CU241</b>	<b>800F-AECU1CU241</b>	<b>800F-PX20</b>
		Illuminated	<b>800FP-LU2X</b>			800F-PN§WX20
RIGHT (white)/LEFT (black)	Single arrow 90°	Non-Illuminated	<b>800FP-U2X</b>	<b>800F-AECU2CU700</b>	<b>800F-AECU1CU700</b>	<b>800F-PX20</b>
		Illuminated	<b>800FP-LU2X</b>			800F-PN§WX20
FORWARD (white)/REVERSE (black)	Single arrow 45°	Non-Illuminated	<b>800FP-U2X</b>	800F-AECU2CU244	<b>800F-AECU1CU244</b>	<b>800F-PX20</b>
		Illuminated	<b>800FP-LU2X</b>			800F-PN§WX20
UP FAST (white)/DOWN FAST (black)	Double arrow 0°	Non-Illuminated	<b>800FP-U2X</b>	<b>800F-AECU2CU261</b>	<b>800F-AECU1CU261</b>	<b>800F-PX20</b>
		Illuminated	<b>800FP-LU2X</b>			800F-PN§WX20
RIGHT FAST (white)/LEFT FAST (black)	Double arrow 90°	Non-Illuminated	<b>800FP-U2X</b>	800F-AECU2CU260	800F-AECU1CU260	<b>800F-PX20</b>
		Illuminated	<b>800FP-LU2X</b>			800F-PN§WX20
FORWARD FAST (white)/REVERSE FAST (black)	Double arrow 45°	Non-Illuminated	<b>800FP-U2X</b>	800F-AECU2CU264	800F-AECU1CU264	<b>800F-PX20</b>
		Illuminated	<b>800FP-LU2X</b>			800F-PN§WX20
<b>Horizontal Mounting</b>						
LEFT (black)/RIGHT (white)	Single arrow 90°	Non-Illuminated	<b>800FP-U2X</b>	<b>800F-AECU1CU241</b>	<b>800F-AECU2CU241</b>	<b>800F-PX20</b>
		Illuminated	<b>800FP-LU2X</b>			800F-PN§WX20
DOWN (black)/UP (white)	Single arrow 0°	Non-Illuminated	<b>800FP-U2X</b>	<b>800F-AECU1CU242</b>	<b>800F-AECU2CU242</b>	<b>800F-PX20</b>
		Illuminated	<b>800FP-LU2X</b>			800F-PN§WX20
REVERSE (black)/FORWARD (white)	Single arrow 45°	Non-Illuminated	<b>800FP-U2X</b>	<b>800F-AECU1CU245</b>	<b>800F-AECU2CU245</b>	<b>800F-PX20</b>
		Illuminated	<b>800FP-LU2X</b>			800F-PN§WX20
LEFT FAST (black)/UP FAST (white)	Double arrow 90°	Non-Illuminated	<b>800FP-U2X</b>	<b>800F-AECU1CU261</b>	<b>800F-AECU2CU261</b>	<b>800F-PX20</b>
		Illuminated	<b>800FP-LU2X</b>			800F-PN§WX20
DOWN FAST (black)/UP FAST (white)	Double arrow 0°	Non-Illuminated	<b>800FP-U2X</b>	<b>800F-AECU1CU262</b>	<b>800F-AECU2CU262</b>	<b>800F-PX20</b>
		Illuminated	<b>800FP-LU2X</b>			800F-PN§WX20
REVERSE FAST (black)/FORWARD FAST (white)	Double arrow 45°	Non-Illuminated	<b>800FP-U2X</b>	800F-AECU1CU265	800F-AECU2CU265	<b>800F-PX20</b>
		Illuminated	<b>800FP-LU2X</b>			800F-PN§WX20

§ Select **3** for 24V AC/DC or **5** for 120V AC.

\* For 24V AC/DC units, add **V** for low voltage contact blocks. Example: **Cat. No. 800F-PX20** becomes **Cat. No. 800F-PX20V**

‡ Electrical interlock cannot be performed within the pendant enclosure.

\* Mechanical interlock is not allowed.



# 22.5 mm Configured Pendant Stations

## Product Selection

### Bul. 800F Pilot Lights — Monolithic



Lens Color	Lamp Voltage	Cat. No.
Green	24V AC/DC	<b>800FD-P3N3</b>
	120V AC	<b>800FD-P3N5</b>
Red	24V AC/DC	<b>800FD-P4N3</b>
	120V AC	<b>800FD-P4N5</b>
Yellow	24V AC/DC	<b>800FD-P5N3</b>
	120V AC	<b>800FD-P5N5</b>
Blue	24V AC/DC	<b>800FD-P6N3</b>
	120V AC	<b>800FD-P6N5</b>
Clear	24V AC/DC	<b>800FD-P7N3</b>
	120V AC	<b>800FD-P7N5</b>

### Bul. 800F Potentiometer Operators\*



Resistive Element (Ω)	Cat. No.
150	<b>800FP-POT1</b>
500	<b>800FP-POT2</b>
1000	<b>800FP-POT3</b>
2500	<b>800FP-POT4</b>
5000	<b>800FP-POT5</b>
10 000	<b>800FP-POT6</b>

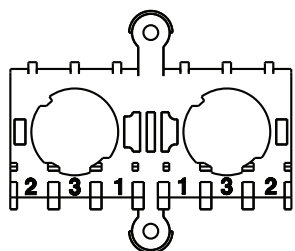
\* Only available in Position 1 for a 3-hole enclosure, Positions 1 and/or 5 for a 5-hole enclosure, Positions 1 and/or 7 for a 7-hole enclosure, and positions 1 and/or 9 for a 9-hole enclosure. No latches are required.

### Bul. 800F Hole Plug

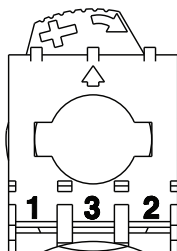


Color	Cat. No.
Black plastic	<b>800F-N2</b>

### 1-, 2-, and 3-Speed Contact Block Assemblies



Cat. No. **800FC-ALP**



Cat. No. **800F-ALP**

Operator Type	Interlock Type	Composite Cat. No.	Separate Catalog Numbers			
			Latch Cat. No.	Contact Block Location 1 Cat. No.	Contact Block Location 2 Cat. No.	Contact Block Location 3 Cat. No.
1-speed	No interlock	<b>800F-PX10E</b>	<b>800F-ALP</b>	—	—	<b>800F-X10E</b>
	Electrical interlock	<b>800F-PX11C</b>	<b>800F-ALP</b>	<b>800F-X01B</b>		
	Mechanical interlock§	<b>800F-LX20C</b>	<b>800FC-ALP</b>	—		
2-speed	Electrical & mechanical interlock§	<b>800F-LX22C</b>	<b>800FC-ALP</b>	<b>800F-X01B</b>	<b>800F-X10N</b> (Speed 2)	<b>800F-X10E</b> (Speed 1)
	No interlock	<b>800F-PX20C</b>	<b>800F-ALP</b>	—		
	Electrical interlock	<b>800F-PX21C</b>	<b>800F-ALP</b>	<b>800F-X01B</b>		
	Mechanical interlock§	<b>800F-LX40C</b>	<b>800FC-ALP</b>	—		
3-speed	Electrical & mechanical interlock§	<b>800F-LX42C</b>	<b>800FC-ALP</b>	<b>800F-X01B</b>	<b>800F-X10E</b> (Speed 2)	<b>800F-X10M</b> (Speed 1)‡
	No interlock	<b>800F-PX30C</b>	<b>800F-ALP</b>	<b>800F-X10N</b>		
	Mechanical interlock§	<b>800F-LX60C</b>	<b>800FC-ALP</b>	<b>800F-X10N</b> (Speed 3)		

※ Contact blocks come preassembled onto latch.

‡ For proper operation, **Cat. No. 800F-X10M** must be mounted in position 3 of either the mechanical or standard latch.

§ When ordering separate components, two pieces of each contact block must be ordered, one for each operator.



Bulletin 800FC  
**22.5 mm Configured Pendant Stations**  
 Catalog Number Explanation

Catalog Number Explanation  
 Configured Pendant Stations

**800FC –**



**Note:** A code from Tables *b...k* and *b<sub>1</sub>...k<sub>1</sub>* must be specified for each operator to create a valid cat. no.

**a**

Enclosure Code					
Voltage	Legend Plate	3-Hole	5-Hole	7-Hole	9-Hole
		Code	Code	Code	Code
24V AC/DC	No	2	4	6	8
120V AC		3	5	7	9
24V AC/DC	Yes	A	C	E	G
120V AC		B	D	F	H

**b...k**

Operator Type		
Single Speed Operators for use with Mechanical Interlock†+‡11		
Code	Description	Legend Plate Text (When Selected)
A2	Black operator (no text or symbol)	Blank
AB	Black operator with arrow (reverse — down/left)	O/H CRANE, REVERSE
AD	Black operator with arrow (down)	LIFT, DOWN
AL	Black operator with arrow (left)	HOIST, LEFT
A1	White operator (no text or symbol)	Blank
AF	White operator with arrow (forward — up/right)	O/H CRANE, FORWARD
AR	White operator with arrow (right)	HOIST, RIGHT
AU	White operator with arrow (up)	LIFT, UP
Fast Single Speed Operators for use with Mechanical Interlock†+‡11		
Code	Description	Legend Plate Text (When Selected)
DB	Black operator with <b>double</b> arrow (reverse fast — down/left)	O/H CRANE, REVERSE, FAST
DD	Black operator with <b>double</b> arrow (down fast)	LIFT, DOWN FAST
DL	Black operator with <b>double</b> arrow (left fast)	O/H CRANE, LEFT FAST
DF	White operator with <b>double</b> arrow (forward fast — up/right)	O/H CRANE, FORWARD, FAST
DR	White operator with <b>double</b> arrow (right fast)	O/H CRANE, RIGHT FAST
DU	White operator with <b>double</b> arrow (up fast)	LIFT, UP FAST
Two-Speed Operators for use with Mechanical Interlock†+‡11		
Code	Description	Legend Plate Text (When Selected)
B2	Black operator (no text or symbol)	Blank
BB	Black operator with arrow (reverse — down/left)	1-2 SPEED, O/H CRANE, REVERSE
BD	Black operator with arrow (down)	1-2 SPEED, LIFT, DOWN
BL	Black operator with arrow (left)	1-2 SPEED, HOIST, LEFT
B1	White operator (no text or symbol)	Blank
BF	White operator with arrow (forward — up/right)	1-2 SPEED, O/H CRANE, FORWARD
BR	White operator with arrow (right)	1-2 SPEED, HOIST, RIGHT
BU	White operator with arrow (up)	1-2 SPEED, LIFT, UP
Three-Speed Operators for use with Mechanical Interlock†‡\$+‡11		
Code	Description	Legend Plate Text (When Selected)
C2	Black operator (no text or symbol)	Blank
CB	Black operator with arrow (reverse — down/left)	1-2-3 SPEED, O/H CRANE, REVERSE
CD	Black operator with arrow (down)	1-2-3 SPEED, LIFT, DOWN
CL	Black operator with arrow (left)	1-2-3 SPEED, HOIST, LEFT
C1	White operator (no text or symbol)	Blank
CF	White operator with arrow (forward — up/right)	1-2-3 SPEED, O/H CRANE, FORWARD
CR	White operator with arrow (right)	1-2-3 SPEED, HOIST, RIGHT
CU	White operator with arrow (up)	1-2-3 SPEED, LIFT, UP

\* Only available in position 1 of a 3-hole enclosure and in positions 1 & 2 of a 5-...9-hole enclosure.

‡ Monolithic style device provided.

† For a 3-hole enclosure, when a mechanical interlock (c1 & d1 = M or B) is selected with a 1-...3-speed operator, the black operator will be located in position 2 of the enclosure and the opposite white operator will be placed in position 3 of the enclosure (Example: ABMAFM or BDMBUM). For a 5-...9-hole enclosure, when a mechanical interlock (b1...k1 = M or B) is selected with a 1-...3-speed operator, the white operator will be located in position X of the mechanical interlock and the opposite black operator will be placed in position X+1 of the mechanical interlock (Example: AFMABM or BUMBDM).

§ Interlock and/or rubber boot selection = N (no interlock, no additional boots) is **not** allowed.

‡ Interlock and/or rubber boot selection = E (electrical interlock, no additional boots) is **not** allowed.

➤ Interlock and/or rubber boot selection = M (mechanical interlock) is **not** allowed.

‡ Interlock and/or rubber boot selection = B (electrical and mechanical interlock) is **not** allowed.

† Interlock and/or rubber boot selection = R (no interlock, additional rubber boot) is **not** allowed.

‡ Interlock and/or rubber boot selection = S (electrical interlock, additional rubber boot) is **not** allowed.

▲ Only available in position 1 for a 3-hole enclosure, positions 1 and/or 5 for a 5-hole enclosure, positions 1 and/or 7 for a 7-hole enclosure, and positions 1 and/or 9 for a 9-hole enclosure.

11 For proper installation, a trim washer or Cat. No. 800F-36\_ legend plate must be installed with this operator.

**b<sub>1</sub>...k<sub>1</sub>**

Interlock and/or Rubber Boot	
Code	Description
N	No interlock, no additional boots
E	Electrical interlock, no additional boots
M	Mechanical interlock, boots standard†
B	Electrical and mechanical interlock, boots standard†
R	No interlock, additional rubber boot
S	Electrical interlock, additional rubber boot

## 22.5 mm Configured Pendant Stations

Catalog Number Explanation

*b...k, continued*

Operator Type		
Emergency Stop Operators**>⊗+⊕		
Code	Description	Legend Plate Text (When Selected)
MT	Red operator — twist-to-release	Not provided
ME	Illuminated red operator — twist-to-release	
MK	Red operator — keyed twist-to-release	
MM	Red operator — twist-to-release/push-pull⊗	
MG	Red operator with guard — twist-to-release/push-pull⊗	
Standard Extended Push Buttons — Non-Illuminated>⊗		
Code	Description	Legend Plate Text (When Selected)
E2	Black operator (no text or symbol)	Blank
ED	Black operator with arrow (down)	LIFT, DOWN
EL	Black operator with arrow (left)	HOIST, LEFT
EB	Black operator with arrow (reverse — down/left)	O/H CRANE, REVERSE
FD	Black operator with <b>double</b> arrow (down fast)	LIFT, DOWN FAST
FL	Black operator with <b>double</b> arrow (left fast)	O/H CRANE, LEFT FAST
FB	Black operator with <b>double</b> arrow (reverse fast — down/left)	O/H CRANE, REVERSE, FAST
E1	White operator (no text or symbol)	Blank
EU	White operator with arrow (up)	LIFT, UP
ER	White operator with arrow (right)	HOIST, RIGHT
EF	White operator with arrow (forward — up/right)	O/H CRANE, FORWARD
FU	White operator with <b>double</b> arrow (up fast)	LIFT, UP FAST
FR	White operator with <b>double</b> arrow (right fast)	O/H CRANE, RIGHT FAST
FF	White operator with <b>double</b> arrow (forward fast — up/right)	O/H CRANE, FORWARD, FAST
E3	Green operator (no text or symbol)⊗⊕	Blank
EQ	Green operator with Start/Alarm symbol⊗⊕	START, ALARM
EN	Green operator with Start symbol⊗⊕	START
E4	Red operator (no text or symbol)⊗⊕	Blank
ES	Red operator with Stop symbol⊗⊕	STOP
E5	Yellow operator (no text or symbol)⊗⊕	Blank
EA	Yellow operator with Alarm symbol⊗⊕	ALARM
E6	Blue operator (no text or symbol)⊗⊕	Blank
R6	Blue operator with R⊗⊕	RESET
Standard Extended Push Buttons — Illuminated⊗>⊗⊕		
Code	Description	Legend Plate Text (When Selected)
L3	Green operator (no text or symbol)	Blank
L4	Red operator (no text or symbol)	Blank
L5	Yellow operator (no text or symbol)	Blank
L6	Blue operator (no text or symbol)	Blank
L7	Clear operator (no text or symbol)	Blank
Selector Switches⊗>⊗⊕		
Code	Description	Legend Plate Text (When Selected)
SH	2-position	Standard-maintained
KH		Keyed-maintained
SJ	3-position	Standard-maintained
KJ		Keyed-maintained

**Note:** Footnote explanations on previous page.

*b...k, continued*

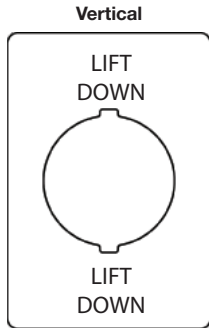
Operator Type		
2- Function Multi-Operator Push Buttons⊗>⊗⊕		
Code	Description	Legend Plate Text (When Selected)
VV	Black/white operator with arrow (down & up)	Not provided
VW	Black/white operator with arrow (left & right)	
VX	Black/white operator with arrow (reverse & forward)	
WV	Black/white operator, illuminated, with arrow (down & up)	
WW	Black/white operator, illuminated, with arrow (left & right)	
WX	Black/white operator, illuminated, with arrow (reverse & forward)	
XV	Black/white operator with <b>double</b> arrows (down fast & up fast)	
XW	Black/white operator with <b>double</b> arrows (left fast & right fast)	
XX	Black/white operator with <b>double</b> arrows (reverse fast & forward fast)	
YV	Black/white operator, illuminated, with <b>double</b> arrows (down fast & up fast)	
YW	Black/white operator, illuminated, with <b>double</b> arrows (left fast & right fast)	
YX	Black/white operator, illuminated, with <b>double</b> arrows (reverse fast & forward fast)	
Pilot Lights⊗>⊗⊕		
Code	Description	Legend Plate Text (When Selected)
P0	Amber LED	Blank
P3	Green LED	Blank
P4	Red LED	Blank
P5	Yellow LED	Blank
P6	Blue LED	Blank
P7	Clear LED	Blank
Potentiometers⊗>⊗⊕		
Code	Description	Legend Plate Text (When Selected)
1P	Black operator — 150 Ω	Blank
2P	Black operator — 500 Ω	Blank
3P	Black operator — 1000 Ω	Blank
4P	Black operator — 2500 Ω	Blank
5P	Black operator — 5000 Ω	Blank
6P	Black operator — 10 000 Ω	Blank
Hole Plug⊗>⊗⊕		
Code	Description	Legend Plate Text (When Selected)
N2	Black hole plug	Blank

*b<sub>1</sub>...k<sub>1</sub>*

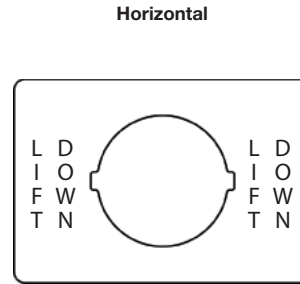
Interlock and/or Rubber Boot	
Code	Description
N	No interlock, no additional boots
E	Electrical interlock, no additional boots
M	Mechanical interlock, boots standard‡
B	Electrical and mechanical interlock, boots standard‡
R	No interlock, additional rubber boot
S	Electrical interlock, additional rubber boot



Accessories  
 Engraved Legend Plates



Cat. No. 800F-36VE416



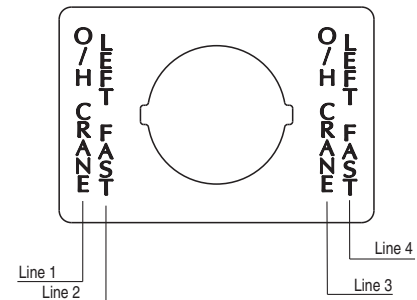
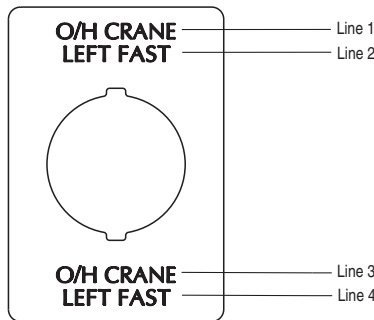
Cat. No. 800F-36HE416

Description	Cat. No.	Description	Cat. No.
Blank	800F-36BE100	1-2-3 SPEED, O/H CRANE, FORWARD	800F-36SE411
O-I	800F-36SU231	1-2-3 SPEED, O/H CRANE, REVERSE	800F-36SE412
I-O-II	800F-36SU234	ALARM	800F-36SE413
RESET	800F-36SE186	HOIST, LEFT	800F-36SE414
START	800F-36SE208	HOIST, RIGHT	800F-36SE415
STOP	800F-36SE212	LIFT, DOWN	800F-36SE416
1-2 SPEED, HOIST, LEFT	800F-36SE401	LIFT, DOWN FAST	800F-36SE417
1-2 SPEED, HOIST, RIGHT	800F-36SE402	LIFT, UP	800F-36SE418
1-2 SPEED, LIFT, DOWN	800F-36SE403	LIFT, UP FAST	800F-36SE419
1-2 SPEED, LIFT, UP	800F-36SE404	O/H CRANE, FORWARD	800F-36SE420
1-2 SPEED, O/H CRANE, FORWARD	800F-36SE405	O/H CRANE, FORWARD, FAST	800F-36SE421
1-2 SPEED, O/H CRANE, REVERSE	800F-36SE406	O/H CRANE, LEFT FAST	800F-36SE422
1-2-3 SPEED, HOIST, LEFT	800F-36SE407	O/H CRANE, REVERSE	800F-36SE423
1-2-3 SPEED, HOIST, RIGHT	800F-36SE408	O/H CRANE, REVERSE, FAST	800F-36SE424
1-2-3 SPEED, LIFT, DOWN	800F-36SE409	O/H CRANE, RIGHT FAST	800F-36SE425
1-2-3 SPEED, LIFT, UP	800F-36SE410	START, ALARM	800F-36SE426
		Custom text	* 800F-36SE100*

§ For vertically mounted operators, add a **V** to the cat. no. Example: **Cat. No. 800F-36SE186** becomes **Cat. No. 800F-36VE186**.  
 For horizontally mounted operators, add an **H** to the cat. no. Example: **Cat. No. 800F-36SE186** becomes **Cat. No. 800F-36HE186**.

\* Font code (**K**, **S**, **L**) must be selected from the following table.

\* Please fill in the custom text fax sheet found on page 112 to ensure accuracy of legend plate engraving.



Font Size	Vertical Mounting (V)		Horizontal Mounting (H)	
	Max. Characters Per Line	Max. No. of Lines	Max. Characters Per Line	Max. No. of Lines
K (small)	16	4	9	4
S (standard)	14	4	8	4
L (large)	10	2	7	2

	Description	Pkg. Quantity	Cat. No.
	Plastic mounting latch	10	800F-ALP
	Mechanical interlock latch	1	* 800FC-ALP
	Replacement wire guide †	10	800FC-AWG
	Replacement trim washer	10	800F-ATW1
	Insulated side jumper	50	1492-SJ5A-24
			1492-SJ5A-10
	Hole plug	1	800F-N2
	Contact block	10	Description
			Type
			N.O.
			N.C.
			N.O. low voltage — QuadCONNECT™
			N.C. low voltage — QuadCONNECT™
			N.C.E.B.
			NOEM* †
	Cable sleeve	1	3-hole (M20 x 1.5)
			5-...9-hole (M32 x 1.5)
	Protective boot	10	Extended push button
			2-position multi-operator
	Narrow plastic guard	1	Yellow
	Integrated LED module	10	24V AC/DC
			120V AC

\* Only for use with 1-, 2-, and 3-speed operators.  
 \* First contact closure of 1- and 2-speed operators.  
 † Second contact closure of 2-speed operators and third contact closure of 3-speed operators.  
 † First contact closure of 3-speed operators.  
 \* For proper operation, **Cat. No. 800F-X10M** must be mounted in position 3 of the mechanical or standard latch.  
 \* Not for use with 1-, 2-, and 3-speed operators.  
 § To complete the cat. no., replace the x with one of the following letters for the desired color: **Y** = Amber, **R** = Red, **G** = Green, **B** = Blue, **W** = White.  
 † Wire guides are provided with enclosures.

# Bulletin 800FC

## 22.5 mm Configured Pendant Stations

### Specifications

#### Specifications\*

#### Front-of-Panel (Operators)

Mechanical Ratings		
Description	Plastic (Bulletin 800FP)	
Vibration (assembled to panel)	Tested at 10...2000 Hz, 1.52 mm displacement (peak-to-peak) max./10 G max. for 3 hr duration, no damage	
Shock	Tested at 1/2 cycle sine wave for 11 ms; no damage at 100 G	
Degree of protection*	IP66 (Type 4/4X/13)	
Mechanical durability per EN 60947-5-1 (Annex C)	10 000 000 Cycles	Momentary push buttons
	1 000 000 Cycles	Multi-function, selector switch, key selector switch
	300 000 Cycles	Twist-to-release E-stop, illuminated push-pull E-stop, alternate action push buttons
	100 000 Cycles	Potentiometer, toggle switch
Operating forces (typical with one contact block)	Flush/extended = 5 N, E-stop = 36 N	
Operating torque (typical application with one contact block)	Selector switch = 0.25 N•m (2.2 lb•in)	
Mounting torque	1.7 N•m (15 lb•in)	
Environmental		
Temperature range (operating)	-25...+70 °C (-13...+158 °F)‡	
Temperature range (short term storage)	-40...+85 °C (-40...+185 °F)	
Humidity	50...95% RH from 25...60 °C (77...140 °F)	

\* Performance Data — see page Important-3 of the Industrial Controls catalog.

‡ Plastic keyed operators are IP66, Type 4/13; not Type 4X.

‡ Operating temperatures below 0 °C (32 °F) are based on the absence of freezing moisture and liquids, UL Recognized to 55 °C (131 °F) - Incandescent module max. 40 °C (104 °F) - fully populated 9-hole pendant enclosure 45 °C (113 °F) with 75 °C wire.

**Note:** Use UL Listed type S or SJ cords, with a smooth outer jacket rated for wet locations use (marked W) and oil resistant outer covering (marked O) such as SOW or SJOW with copper wire, rated 75 °C min., 18...12 AWG, with an overall OD of 7.5...15 mm for the small cable sleeve (**Cat. No. 800FC-AS3**) and 9...22.5 mm for the large cable sleeve (**Cat. No. 800FC-AS5**).

#### Material Listing

Component	For Use with	Material Used
Panel gasket	All operators	Nitrile, TPE
Diaphragm seal	Illuminated push button, non-illuminated push button	Automotive industry acceptable silicone
K-seal	Selector switch, key selector switch, push/twist-to-release E-stop, key E-stop	Nitrile
Diaphragm retainer, return spring I	Illuminated push button, non-illuminated push button	Stainless steel
Return spring II	Selector switch, key selector switch, alternate action, push/twist-to-release E-stop, key E-stop	Zinc-coated music wire
Button cap	Non-illuminated push button, push/twist-to-release, E-stop, key E-stop, multi-function	PBT/polycarbonate blend
2-color molded button cap	Non-illuminated push button	PBT/polycarbonate blend
Lens	Multi-function	Acetal
Lens, knob	Illuminated push button	Polyamide
Knob	Non-illuminated selector switch	Glass-filled polyamide
Plastic bezel/bushing I	Non-illuminated push button, illuminated push button, selector switch, key selector switch, push/twist-to-release E-stop, key E-stop, multi-function	Glass-filled polyamide
Plastic bezel/bushing II	Pilot light	Glass-filled PBT
Diffuser	Illuminated push button, pilot light	Polycarbonate
Plastic mounting ring	All plastic operators	Glass-filled polyamide
Plastic latch	—	Glass-filled polyamide
Mechanical interlock latch	—	Glass-filled polyamide
Plastic enclosure	—	PBT/polycarbonate blend
Terminal screws	LED module, contact blocks	Zinc-plated steel with chromate
Terminals	LED module, contact blocks	Brass with silver-nickel contacts
Housing	LED module	Glass-filled polyamide
Low-voltage terminals	Contact blocks	Gold-plated silver-nickel contacts
Low-voltage spanner	Contact blocks	Gold-plated silver-nickel contacts
Spanner	Contact blocks	Brass with silver-nickel contacts
Boot	Illuminated push button, non-illuminated push button, multi-function illuminated and non-illuminated	Automotive industry acceptable silicone

## 22.5 mm Configured Pendant Stations

### Specifications

#### Back-of-Panel Components\*

Electrical Ratings			
Standard contact block ratings		A600, Q600 600V AC AC 15, DC 13 to IEC/EN 60947-5-1 and UL 508, 17V, 5 mA min.	
Low voltage contact block ratings*		5V, 1 mA DC min. C300, R150, AC 15, DC 13 to EN 60947-5-1 and UL 508	
Nominal Voltage		Range	Current Draw
LED Module Ratings			Frequency
	24V AC	10...29V AC	31 mA
	24V DC	10...30V DC	24 mA
	120V AC	70...132V AC	25 mA
	240V AC	180...264V AC	22 mA
Thermal current		10 A max. enclosed (40 °C ambient) to UL508, EN 60947-5-1	
Insulation voltage (U <sub>i</sub> )		Screw terminal = 690V, spring-clamp = 300V	
Wire capacity (screw terminal)‡		#18...12 AWG (0.75...2.5 mm <sup>2</sup> ) Max. (2) #14 AWG or (1) #12 AWG	
Wire capacity (spring-clamp terminal)		#18...14 AWG (0.75...1.5 mm <sup>2</sup> ) One per spring clamp, two spring clamps per terminal	
Recommended tightening torque on screw terminals		0.7...0.9 N•m (6...8 lb•in)	
Dielectric strength (minimum)		2500V for one minute	
External short circuit protection		Standard blocks	
		10 A type gL/gG cartridge fuse to EN 60269-2-1 or gN (Class J to UL 248-8 or Class C to UL 248-4)	
Electrical shock protection		Low voltage contact blocks	
		6 A type gL/gG cartridge fuse to EN 60269-2-1 or gN (Class J to UL 248-8 or Class C to UL 248-4)	
Finger-safe conforming to IP2X			
Mechanical Ratings			
Vibration (assembled to panel)		Tested at 10...2000 Hz, 1.52 mm displacement (peak-to-peak) max./10 G max. 6 hr	
Shock		Tested at 1/2 cycle sine wave for 11 ms and no damage at 100 G max.	
Contact durability per EN 60947-5-1 (Annex C)		10 000 000 cycles	
Contact operation		N.O.	
		Slow double make and break	
N.C.		Slow double make and break — positive opening	
		↔	
N.O.E.M.		Double break / double make, early make	
N.C.L.B.		Double break / double make, late break — positive opening	
		↔	
N.C.E.B.		Double break / double make, early break — positive opening	
N.O.E.E.M.		Double break / double make, early early make	
		↔	
N.O.L.M.		Double break / double make, late make	
Standard push button travel to change electrical state		N.C. and N.O.E.M.	
		1.5 mm (0.060 in.)	
Multi-speed push button travel to change electrical state		N.O. and N.C.L.B.	
		2.5 mm (0.1 in.)	
Operating forces (typical)		N.O.E.E.M.	
		3 mm (0.12 in.)	
Single-circuit contact block		N.C.E.B.	
		4 mm (0.16 in.)	
Dual-circuit contact block		N.O.L.M.	
		7 mm (0.28 in.)	
3.4 N		5...6.5 N	
Illumination			
LED Dominant Wavelength		Green	
		525 nm	
		Red	
		629 nm	
		Yellow	
		590 nm	
		Blue	
		470 nm	
		White	
		—	
LED Luminous Intensity		Green	
		780 mcd	
		Red	
		780 mcd	
		Yellow	
		600 mcd	
		Blue	
		168 mcd	
		White	
		360 mcd	
Materials			
Springs		Stainless steel and zinc coated music wire	
Electrical contacts		Standard	
		Silver-nickel	
		Low voltage	
		Gold-plated over silver	
Terminals		Screw	
		Brass	
		Spring-clamp	
		Silver-plated brass	

\* Performance Data — see page Important-3 of the Industrial Controls catalog.

\* Low voltage contacts are recommended for applications below 17V, 5 mA.

‡ Wires less than #18 AWG (0.75 mm<sup>2</sup>) may not hold in terminal securely.



**Allen-Bradley**

www.ab.com/catalogs Preferred availability cat. nos. are **bold**.

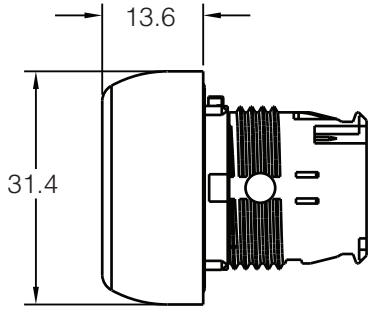
Publication A117-CA001A-EN-P

## 22.5 mm Configured Pendant Stations

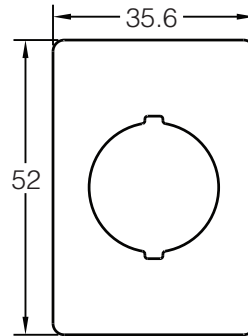
### Approximate Dimensions

#### Approximate Dimensions \*

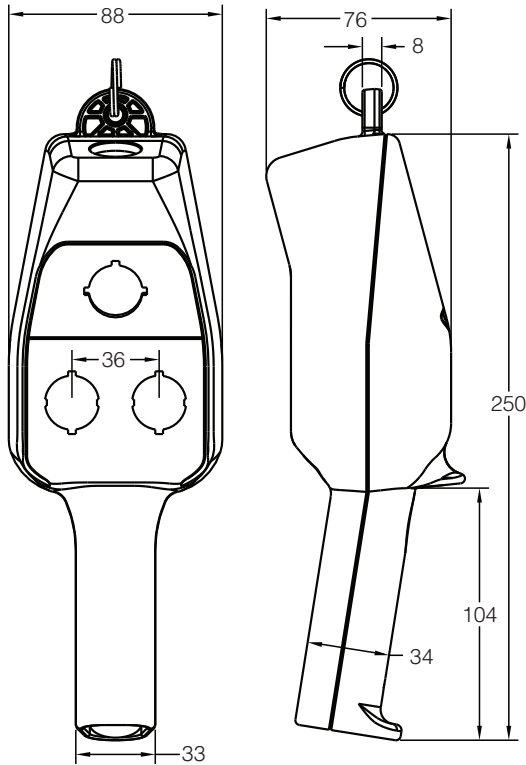
#### Bul. 800FC 1-, 2-, and 3-Speed Operator



#### Bul. 800FC Legend Plate

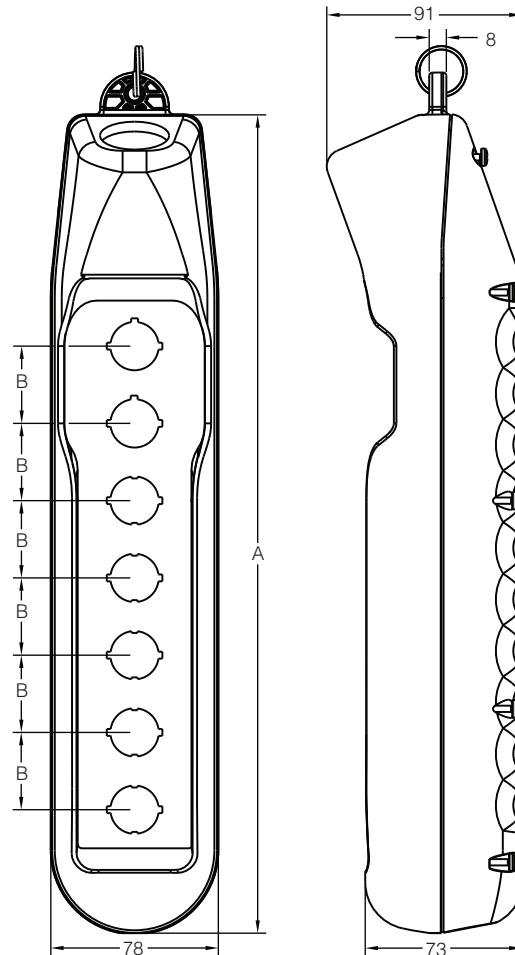


#### Bul. 800FC Pendant Station (3-Hole)



#### Bul. 800FC Pendant Station (5-, 7-, and 9-Hole)

Cat. No.	No. of Holes	A	B
800FC-4/5/C/D	5	309	36
800FC-6/7/E/F	7	381	36
800FC-8/9/G/H	9	453	36

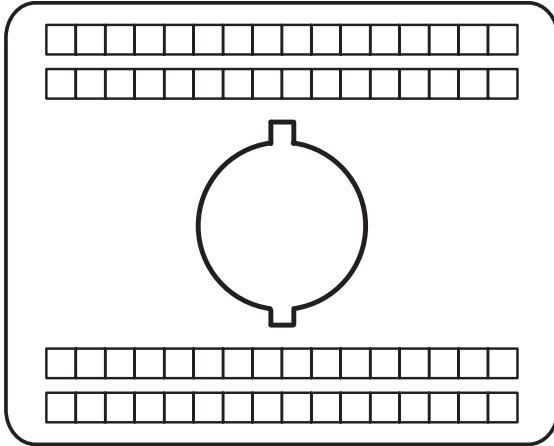


\* For Bul. 800F operator dimensions, see page 10-120.

Custom Text Fax/Scan Sheet

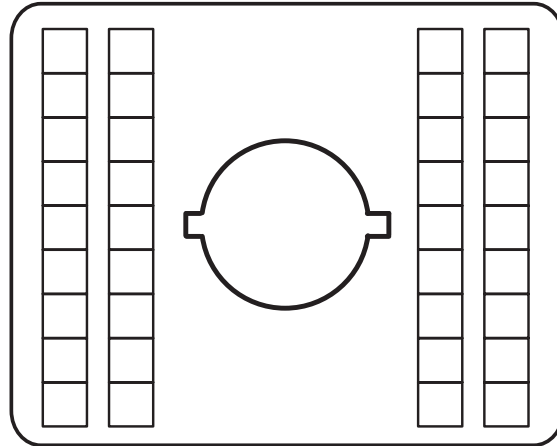
Order/Item \_\_\_\_\_

Vertical Mounting

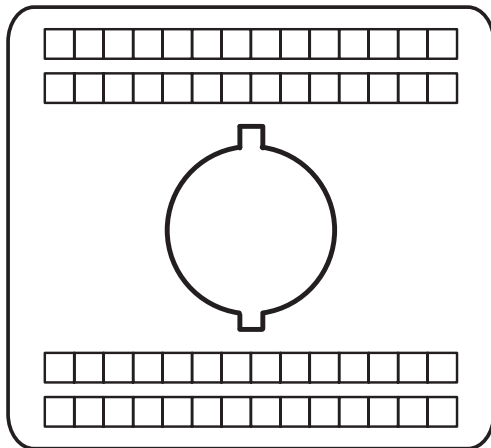


**Cat. No. 800F-36VE100K**

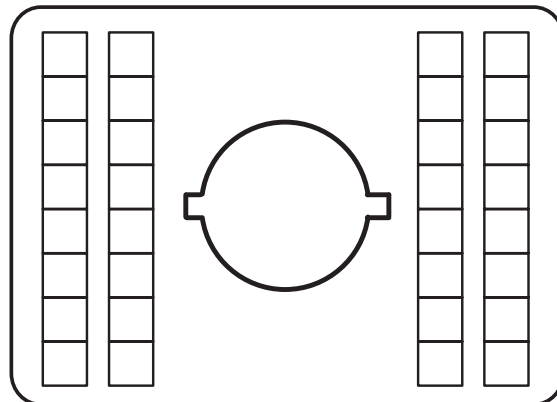
Horizontal Mounting



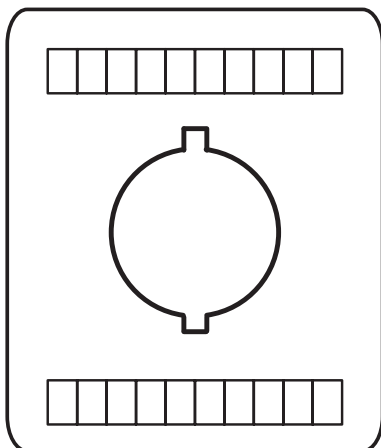
**Cat. No. 800F-36HE100K**



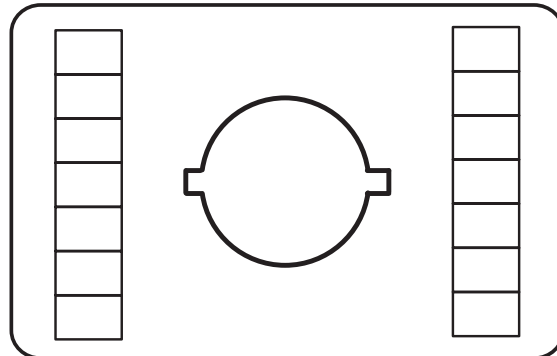
**Cat. No. 800F-36VE100S**



**Cat. No. 800F-36HE100S**



**Cat. No. 800F-36VE100L**



**Cat. No. 800F-36HE100L**

# 22.5 mm Monolithic Push Buttons

## Product Overview/Selection



### Bulletin 800FD Monolithic Push Buttons

With a single catalog number, you can now order a fully assembled product for easy stocking and installation. Designed to meet worldwide standards, the Bul. 800FD monolithic line includes E-stops and pilot lights with either LED or incandescent options.

- Ease of installation
- Low back-of-panel profile (45.7 mm)
- Aesthetic design complements the Bul. 800F modular line
- Anti-rotation tab provides accurate alignment and can be easily removed for use in panels without notches
- Lowest cost of installation
- Made of industrial-grade thermoplastic for superior chemical resistance
- Designed to meet worldwide standards
- Compatible with Bul. 800F accessories and enclosures
- Ring lug capability

### Table of Contents

Push Buttons..... this page  
 Pilot Lights ..... 10-141  
 Selector Switches..... 10-142  
 Mushroom/E-Stops... 10-142  
 Accessories..... 10-143  
 Specifications..... 10-144  
 Approximate Dimensions..... 10-145

### Product Selection

#### Momentary Push Button Operators, Non-Illuminated



Operator Type	Cap Color	Pkg. Quantity	Contact Configuration		
			1 N.O. Cat. No.	1 N.C. Cat. No.	1 N.O. & 1 N.C. Cat. No.
Flush	Black	1	<b>800FD-F2X10</b>	<b>800FD-F2X01</b>	800FD-F2X11
	Green		<b>800FD-F3X10</b>	800FD-F3X01	<b>800FD-F3X11</b>
	Red		<b>800FD-F4X10</b>	800FD-F4X01	<b>800FD-F4X11</b>

**800FD** – **F**    **3**    **01**    **X**    **11**  
*a*    *b*    *c*    *d*    *e*

**a**

Operator Type	
Code	Description
F	Flush
E	Extended

**b**

Color Cap	
Code	Color
1	White
2	Black
3	Green
4	Red
5	Yellow
6	Blue

**c**

Legend Text**	
Code	Text
—	No text (blank)
01	START
02	STOP
05	O
06	I
08	→
09	FORWARD
10	REVERSE
11	R

\* White and yellow caps have black text. All other color caps have white text.  
 \*\* Valid color cap/legend text combinations are as follows:

**d**

Termination Style	
Code	Description
X	Standard screw
R	Ring lug

**e**

Contact Module		
Code	Number of N.O.	Number of N.C.
01	0	1
10	1	0
11	1	1
02	0	2
20	2	0

Color	Text	
	Flush Caps	Extended Caps
White	START, I, →, FORWARD, REVERSE, R	→, R
Black	→, FORWARD, REVERSE, R	STOP, O, →, R ‡
Green	START, I, →, FORWARD, REVERSE	→
Red	→, FORWARD, REVERSE	STOP, O, → ‡
Yellow	→, FORWARD, REVERSE	→
Blue	→, FORWARD, REVERSE, R	→, R

‡ "STOP" or "O" color cap/legend text are not available for "10" or "20" contact modules.





Pilot Light Devices — LED



Lens & LED Color	Pkg. Quantity	Voltage		
		24V AC/DC Cat. No.	120V AC Cat. No.	240V AC Cat. No.
Green	1	800FD-P3N3	800FD-P3N5	800FD-P3N7
Red		800FD-P4N3	800FD-P4N5	800FD-P4N7
Yellow		800FD-P5N3	800FD-P5N5	800FD-P5N7

800FD - P 3 N 7         
                                   a                                  b                                  c

**a**

Lens Cap	
Code	Color
0	Amber
3	Green
4	Red
5	Yellow
6	Blue
7	Clear

**b**

Voltage	
Code	Type
3	24V AC/DC
5	120V AC
7	240V AC

**c**

Termination Style	
Code	Description
Blank	Standard screw
R	Ring lug

Pilot Light Devices — Incandescent

Lens & LED Color	Pkg. Quantity	Voltage	
		24V AC/DC Cat. No.	120V AC Cat. No.
Green	1	800FD-P3D3	800FD-P3D5
Red		800FD-P4D3	800FD-P4D5
Yellow		800FD-P5D3	800FD-P5D5

800FD - P 3 D 5         
                                   a                                  b                                  c

**a**

Lens Cap	
Code	Color
0	Amber
3	Green
4	Red
5	Yellow
6	Blue
7	Clear
9	No lens*

**b**

Voltage	
Code	Type
0	No Bulb*
1	6V AC/DC
2	12V AC/DC
3	24V AC/DC
4	48V AC/DC
5	120V AC/DC

**c**

Termination Style	
Code	Description
Blank	Standard screw
R	Ring lug

\* Only valid with "no bulb" option.  
 \* Only valid with "no lens" option.



# 22.5 mm Monolithic Push Buttons

## Product Selection/Accessories

### Plastic Enclosures — 1-Hole Only

- Feed-through design
- Knockout sizes: PG 11/16
- Not UL Listed or CSA Certified
- Monolithic or latch-mounted contact blocks
- Double insulated



Type	Pkg. Quantity	Plastic Enclosures (IP66, NEMA 4/4X/13)*	
		Grey	Yellow
		Cat. No.	Cat. No.
1-hole	1	<b>800FD-1P</b>	<b>800FD-1PY</b>

\* Can only use single deep contact block.

### Assembled Stations

Enclosure Color	Quick Connect	Operator Type	Contact Configuration	Cat. No.
Grey	N/A	2-position selector switch	1 N.O.	800FD-1SP5
			1 N.O./1 N.C.	800FD-1SP6
	DC Micro 4-pin		800FD-1SP6Q	
Yellow	N/A	Red 40 mm push-pull/twist-to-release	1 N.O./1 N.C.	800FD-1SYP2
	DC Micro 4-pin			800FD-1SYP2Q

### Accessories

#### Replacement Lamps

Lamp	Type	Typical Current	Voltage	ANSI No.	Pkg. Quantity	Cat. No.
 Cat. No. 800F-N130	Full Voltage Incandescent	150 mA	6V AC/DC	755	10‡	<b>800F-N65</b>
		80 mA	12V AC/DC	756		800F-N141
		70 mA	24V AC/DC	757		<b>800F-N157</b>
		50 mA	48V AC/DC	1835		<b>800F-N48</b>
		22 mA	130V AC/DC	949		<b>800F-N130</b>
 Cat. No. 800F-N240	Neon	2 mA	240V AC	—		<b>800F-N240</b>


#### Replacement Lenses

Lens Color	Pkg. Quantity	Cat. No.
Amber	10‡	800FD-AP0
Green		<b>800FD-AP3</b>
Red		<b>800FD-AP4</b>
Yellow		800FD-AP5
Blue		800FD-AP6
Clear		800FD-AP7

‡ Sold in multiples of 10. Order (quantity of) 10 to receive one package of 10 pieces.

Bulletin 800FD  
**22.5 mm Monolithic Push Buttons**  
 Specifications

Specifications\*

Mechanical Ratings			
Vibration (assembled to panel)	Tested at 10...2000 Hz, 1.52 mm displacement (peak-to-peak) max./10 G max. for 3 hr duration, no damage		
Shock	Tested at 1/2 cycle sine wave for 11 ms; no damage at 100 G		
Degree of protection	IP66 (Type 3/3R/4/4X/12/13)		
Mechanical durability per EN 60947-5-1 (Annex C)	300 000 cycles	Selector switch	
	2 000 000 cycles	Push-pull/twist-to-release E-stop Momentary push buttons	
Operating forces	E-stop = 36 N		
Operating torque (typical application with one contact block)	Selector switch = 0.25 N•m		
	N.O.	Slow double make and break	
Contact operation	N.C.	Slow double make and break - positive opening	
			
Push button travel to change electrical state	N.O.	2.5 mm (0.1 in.)	
	N.C.	1.5 mm (0.060 in.)	
Environmental			
Temperature range (operating)	-25...+60 °C (-13...+140 °F)*		
Temperature range (short term storage)	-40...+85 °C (-40...+185 °F)		
Humidity	50...95% RH from 25...60 °C (77...140 °F)		
Electrical Ratings			
Standard contact block ratings	B300, R300 AC 15, DC 13 300 VAC EN/IEC 60947-5-1 and UL 508, 17V, 5 mA min.		
	<b>Nominal Voltage</b>	<b>Range</b>	<b>Current Draw</b>
LED module ratings	24V AC	20...26V AC	32 mA
	24V DC	18...30V DC	24 mA
	120V AC	102...132V AC	22 mA
	240V AC	204...264V AC	22 mA
Frequency	50/60 Hz DC 50/60 Hz 50/60 Hz		
Thermal current	5 A max. enclosed (40 °C ambient) to UL 508, EN/IEC 60947-5-1		
Insulation voltage (U <sub>i</sub> )	300V		
Wire capacity (screw terminal)	#18...14 AWG (0.75...2.5 mm <sup>2</sup> ) Max. (2) #14 AWG, uses same size wire only		
Recommendations for ring lug termination option‡	6.35 mm (0.250 in.) Max. outer diameter with 3.8 mm (0.148 in.) hole diameter		
Recommended tightening torque on screw terminals	0.7...0.9 N•m (6...8 lb•in)		
Dielectric strength (minimum)	2500V for one minute		
External short circuit protection	5 A Type gL/gG cartridge fuse to EN 60269-2-1 or gN (Class J to UL 248-8 or Class CC to UL 248-4)		
Electrical shock protection	Finger-safe conforming to IP2X		
Illumination			
LED dominant wavelength	Green	525 nm	
	Red	629 nm	
	Yellow	590 nm	
	Blue	470 nm	
	White	—	
LED luminous intensity	Green	780 mcd	
	Red	780 mcd	
	Yellow	600 mcd	
	Blue	168 mcd	
	White	360 mcd	
Incandescent maximum wattage	2.6 W		

\* Performance Data — see page Important-3 of the Industrial Controls catalog.

\* Operating temperatures below 0 °C (32 °F) are based on the absence of freezing moisture and liquids.

‡ 3M MV018-R/S (#22...18 AWG) or 3M MVU14-6R/S (#16...14 AWG)





# 16 mm Push Buttons

## Product Overview/Specifications



### Bulletin 800B — 16 mm Push Buttons

- Designed to worldwide standards (UL, CSA, CE, and CCC)
- Durable materials
  - Operators are made of corrosion-proof plastic to ensure long push button life
  - Consistent coloring and illumination make these easy to identify for the life of the operator
- Ease of installation
- Ergonomic design
  - Contoured button surface
- Dependable sealing
  - IP66 and Type 4/13
  - Diaphragm seals: linear travel devices, pilot lights
  - V-seals: selector switches, high pressure sealing
  - K-seals: emergency stops, dual wiping action
- Reliable low voltage switching
  - Gold-plated snap action contacts
  - Reliable operation in applications below 24V DC, 5 mA down to 5V DC, 1 mA
- Enhanced E-stop functionality
  - Anti-tease feature standard (trigger-action)
  - EN13850 and EN 60947-5-5 compliant
  - Direct Drive mechanism (positive actuation)





### Table of Contents

Product Selection ..... this page  
 Accessories..... 10-149  
 Specifications..... 10-150  
 Approximate Dimensions..... 10-151

### Standards Compliance and Certifications

<b>Certifications</b>	UR, CSA, CCC, CE
<b>Standards Compliance</b>	UL 508, EN ISO 13850, EN 60947-1, EN 60947-5-1, EN 60947-5-5
<b>Terminal Identification</b>	EN/IEC 60947-1
<b>RoHS Compliant</b>	✓

### Push Button & Pilot Light Operators\*

Operator Type	Cat. No.			
				
	Round	Square	Rectangle	Large Square
Momentary, push button/pilot light	<b>800B-EPA</b>	<b>800B-EPB</b>	<b>800B-EPC</b>	<b>800B-EPD</b>
Maintained, push button	<b>800B-EAA</b>	<b>800B-EAB</b>	<b>800B-EAC</b>	<b>800B-EAD</b>

**Note:** Package Quantity = 1

\* All operators are sold without a lens cap and diffuser.

### Lens Cap with Diffuser§



Cat. No. 800B-ALA3



Cat. No. 800B-ALB4



Cat. No. 800B-ALC5



Cat. No. 800B-ALD6









Lens Color	Cat. No.			
	Round	Square	Rectangle	Large Square
Green	<b>800B-ALA3</b>	<b>800B-ALB3</b>	<b>800B-ALC3</b>	<b>800B-ALD3</b>
Red	<b>800B-ALA4</b>	<b>800B-ALB4</b>	<b>800B-ALC4</b>	<b>800B-ALD4</b>
Yellow	<b>800B-ALA5</b>	<b>800B-ALB5</b>	<b>800B-ALC5</b>	<b>800B-ALD5</b>
Blue	<b>800B-ALA6</b>	<b>800B-ALB6</b>	<b>800B-ALC6</b>	<b>800B-ALD6</b>
White	<b>800B-ALA7</b>	<b>800B-ALB7</b>	<b>800B-ALC7</b>	<b>800B-ALD7</b>

**Note:** Package Quantity = 1

§ For illuminated devices, LED bulbs are color specific. (Green LED bulb with green lens caps, red LED bulbs with red lens cap, white LED bulbs used with yellow, blue, and white lens cap.) Incandescent bulbs can be used with any lens cap color.








**Selector Switch Operators\***

Operator Type	2-Position Selector Switches		3-Position Selector Switches	
				
	Maintained	Return from Right	Maintained	Return from Both
Cat. No.	<b>800B-SM2A</b>	<b>800B-SR2A</b>	<b>800B-SM3A</b>	<b>800B-SB3A</b>
Operator Type				
	Keyed, Maintained	Keyed, Return from Right	Keyed, Maintained	Keyed, Return from Both
Cat. No.	<b>800B-KM2A</b>	<b>800B-KR2A</b>	<b>800B-KM3A</b>	<b>800B-KB3A</b>

**Note:** Package Quantity = 1


**Target Table and Operator Position**

Contact Block Cat. No.	Contact Block Location	Contact Type	2-Position Target Table		3-Position Target Table		
							
800B-PS11	Top	NA	—	—	—	—	—
	Bottom	N.C.	X	O	O	X	X
		N.O.	O	X	X	O	O
800B-PS22	Top	N.C.	X	O	X	X	O
		N.O.	O	X	O	O	X
	Bottom	N.C.	X	O	O	X	X
		N.O.	O	X	X	O	O
800B-PT01	Top	NA	—	—	—	—	—
	Bottom	N.C.	X	O	O	X	X
800B-PT02	Top	N.C.	X	O	X	X	O
	Bottom		X	O	O	X	X
800B-PT11	Top	N.O.	O	X	O	O	X
	Bottom	N.C.	X	O	O	X	X

**Note:** X = Closed/O = Open

\* To illuminate a selector switch, add either an LED or incandescent bulb. All selector switches have a clear lens. Green and red LED bulbs can be used to change the selector switch color.

**Emergency Stop Operators — Non-Illuminated, Twist-to-Release (Trigger Action)‡**

	Description	Pkg. Quantity	Cat. No.
 <i>Cat. No. 800B-MT</i>	Emergency stop operator	1	<b>800B-MT</b>

‡ Operator is EN ISO 13850 compliant with standard N.C. contact blocks.




Bulletin 800B  
**16 mm Push Buttons**  
 Product Selection

**Contact Block/Latch Module**

	Description	Pkg. Quantity	Cat. No.
<b>Push Button/Selector Switch</b>			
 <i>Cat. No. 800B-PS11</i>	1 N.O./1 N.C. snap action	1	<b>800B-PS11</b>
 <i>Cat. No. 800B-PS22</i>	2 N.O./2 N.C. snap action	1	<b>800B-PS22</b>
<b>Pilot Light</b>			
 <i>Cat. No. 800B-PL</i>	Dummy block	1	<b>800B-PL</b>
<b>Emergency Stop/Push Button/Selector Switch</b>			
 <i>Cat. No. 800B-PT01</i>	1 N.C. slow make/break	1	<b>800B-PT01</b>
 <i>Cat. No. 800B-PT02</i>	2 N.C. slow make/break	1	<b>800B-PT02</b>
 <i>Cat. No. 800B-PT11</i>	1 N.O./1 N.C. slow make/break	1	<b>800B-PT11</b>

**Replacement Bulbs**

10

	Description	Lamp Color	Lamp Voltage	Pkg. Quantity	Cat. No.
	LED bulb*	Green	12...24V AC/DC	1	<b>800B-N3G</b>
			120V AC		<b>800B-N5G</b>
		Red	12...24V AC/DC		<b>800B-N3R</b>
			120V AC		<b>800B-N5R</b>
		White	12...24V AC/DC		<b>800B-N3W</b>
			120V AC		<b>800B-N5W</b>
	Incandescent bulb*	Clear	6V AC/DC	<b>800B-N1C</b>	
			12V AC/DC	<b>800B-N2C</b>	
			24V AC/DC	<b>800B-N3C</b>	

\* Not available in 6V AC/DC.  
 \* Not available in 120V AC.

Accessories

	Description	Pkg. Quantity	Cat. No.
 Cat. No. 800B-ARP	Replacement mounting ring	10	800B-ARP
 Cat. No. 800B-AW2	Mounting ring wrench	1	800B-AW2
 Cat. No. 800B-ALR1	Bulb removal tool	1	800B-ALR1
 Cat. No. 800B-ALR2	Lens removal tool	1	800B-ALR2
 Cat. No. 800B-ALW1	Locking washer (anti-rotation)	10	800B-ALW1
 Cat. No. 800B-ATK	Stab connector (insulated)	10	800B-ATK
 Cat. No. 800B-N2	Hole plug	10	800B-N2
 Cat. No. 800B-AK1	Replacement key	1	800B-AK1
 Cat. No. 800B-APCB	Printed circuit board pin socket	10	800B-APCB
 Cat. No. 800B-15YE112	Emergency stop legend plate	1	800B-15YE112
 Cat. No. 800B-ABZB	Square bezel	10	800B-ABZB
 Cat. No. 800B-ABZC	Rectangle bezel	10	800B-ABZC
 Cat. No. 800B-ABZD	Large square bezel	10	800B-ABZD

10

**Bulletin 800B**  
**16 mm Push Buttons**  
**Specifications**

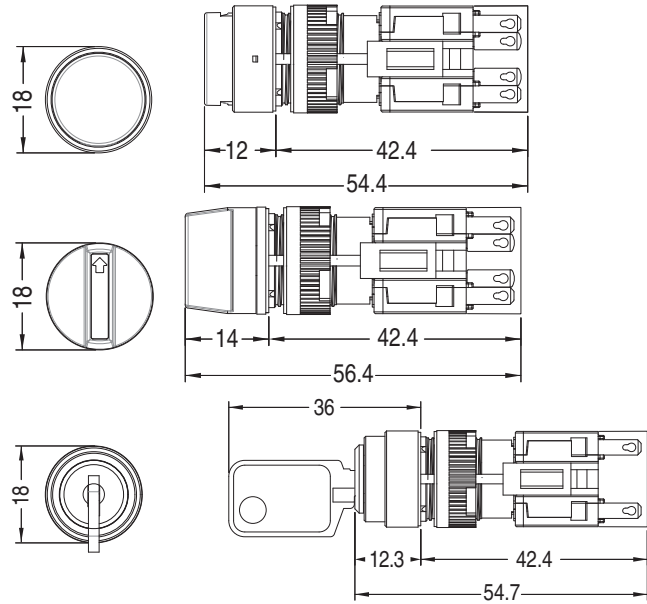
**Specifications**

Mechanical Ratings			
Vibration (assembled to panel)	Tested at 10...2000 Hz, 1.52 mm displacement (peak-to-peak) max./10 G max. for 6 hr duration, no damage		
Shock	Tested at 1/2 cycle sine wave for 11 ms; no damage at 100 G		
Degree of protection*	IP66, Type 4/4X/13		
Mechanical durability per EN 60947-5-1 (Annex C)	2 000 000 Cycles	Push buttons – momentary	
	1 000 000 Cycles	Push buttons – maintained	
	250 000 Cycles	Selector switch	
	200 000 Cycles	Key selector switch	
	200 000 Cycles	Twist-to-release E-stop	
Operating forces (typical with one contact block)	Extended = 5...8 N E-stop = 14...16 N		
Operating torque (typical application with one contact block)	Selector switch = 0.06 N•m (0.5 lb•in)		
Mounting torque	1.1 N•m (10 lb•in)		
Environmental			
Temperature range (operating)	-25...+55 °C (-13...+131 °F)		
Temperature range (short term storage)	-40...+70 °C (-40...+158 °F)		
Humidity	50...95% RH from 25...60 °C (77...140 °F)		
Mechanical Ratings — Contact Blocks			
Vibration (assembled to panel)	Tested at 10...2000 Hz, 1.52 mm displacement (peak-to-peak) max./10 G max. 6 hr		
Shock	Tested at 1/2 cycle sine wave for 11 ms and no damage at 100 G max.		
Contact durability	200 000 cycles (Cat. No. 800B-PS_)		
Contact operation	N.O. / N.C.	Snap action	
	N.C.	Slow make/break positive opening	
	N.O.	Slow make/break	
Push button travel to change electrical state	1.4 mm (0.06 in.)		
Operating forces (typical)	1 contact block = 3 N 2 contact blocks = 6 N		
Electrical Ratings			
Standard contact block ratings	AC 15, B300, 1.5 A/240V AC, 3 A/120V AC DC 13, R300, 0.1 A/250V DC, 0.22 A/125V DC		
LED Module ratings	<b>Nominal Voltage</b>	<b>Current</b>	<b>Frequency</b>
	12...24V AC	12 mA	50/60 Hz
	12...24V DC 120V AC	12 mA 9 mA	DC 50/60 Hz
Thermal current	$I_{th} = 5 \text{ A (AC)}, I_{th} = 1 \text{ A (DC)}$		
Insulation voltage ( $U_i$ )	300V		
Stab termination	2.8 X 0.5 mm		
Dielectric strength (minimum)	1500V 1 min.		
External short circuit protection – standard blocks	6 A type gL/gG cartridge fuse to EN 60269-2-1 or gN (Class J to UL 248-8 or Class C to UL 248-4)		
Electrical shock protection	Finger-safe conforming to IP2X		
Illumination			
LED Dominant wavelength	Green	525 nm	
	Red	624 nm	
	White	—	
LED Luminous intensity	Green	500 mcd	
	Red	400 mcd	
	White	1000 mcd	
Incandescent maximum wattage	1.2 W		
Materials			
Springs	Stainless steel and gold-plated, high-carbon steel		
Electrical contacts	Gold-plated silver		
Stab terminals	Phosphor bronze with gold or nickel plating		
Lenses	Polycarbonate		

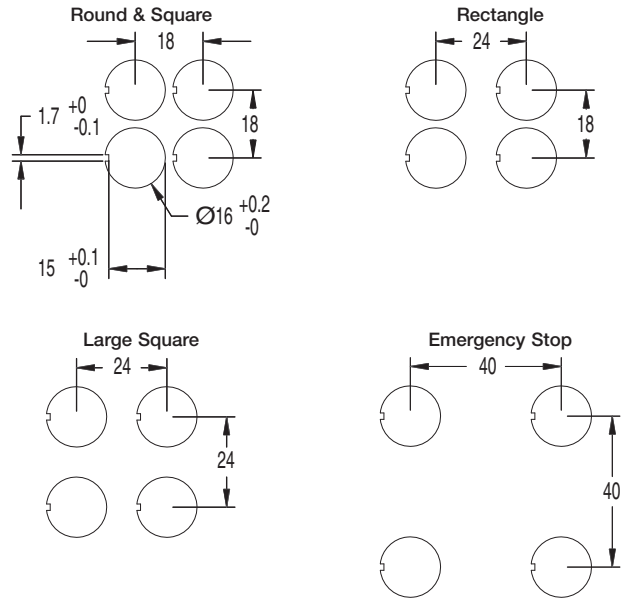


Approximate Dimensions

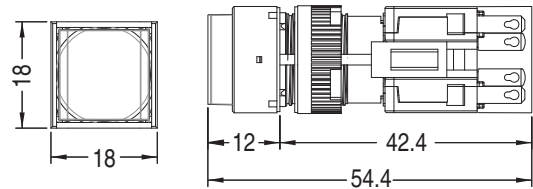
Round



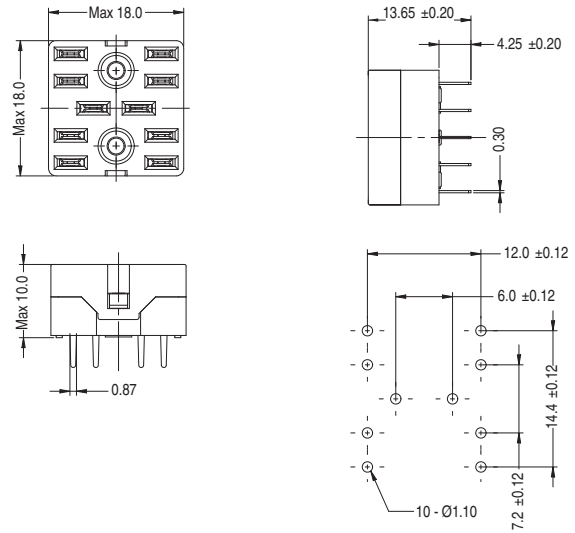
Hole Patterns



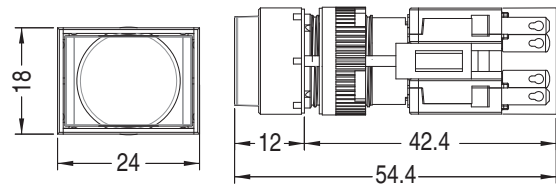
Square



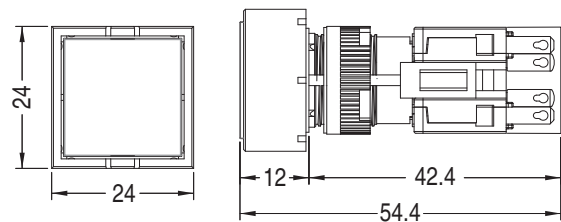
Printed Circuit Board Pin Socket



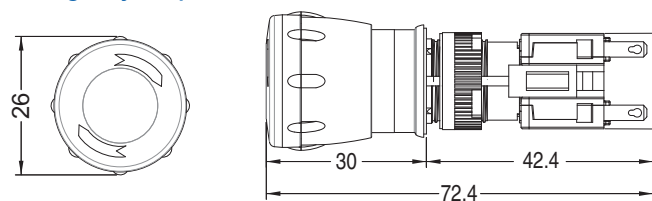
Rectangle



Large Square



Emergency Stop



# Hazardous Location Push Buttons

## Product Overview/Specifications



### Bulletin 800H/Hazardous Location Push Buttons

- Hazardous locations push buttons and stations
- Classes I, II & III Divisions 1 & 2
- 3/4 in. - 14 NPSM barrel
- Type 7 & 9
- Explosion-proof operators

### Table of Contents

**See below.**

**Standards Compliance**  
UL698, UL1604  
CSA 22.2, No. 14

**Certifications**

**Enclosures:**  
UL Listed (File No. E71673  
Guide No. NNNY)

**Devices:**  
UL Listed (File No. E10314  
Guide No. NOIV)

**Stations:**  
CSA (File No. LR11924)

### TABLE OF CONTENTS

Description	Page
<b>Specifications</b> .....	10-153
<b>Complete Assembled Stations</b> .....	10-154
<b>Push Buttons, Momentary</b>	
Non-Illuminated — Flush, Extended, Mushroom, Dual.....	10-155
Illuminated — Extended .....	10-157
<b>Potentiometer</b> .....	10-157
<b>Push Buttons, Push-Pull</b>	
Non-Illuminated — 2- and 3-Postition .....	10-159
Illuminated — 2- and 3-Postition .....	10-161
<b>Selector Switches</b>	
Non-Illuminated, 2-Position.....	10-163
Non-Illuminated, 3-Position.....	10-165
Non-Illuminated, 4-Position.....	10-167

Description	Page
<b>Pilot Light Units</b> .....	10-169
<b>Ordering Information for Stations</b> .....	10-171
<b>Covers</b> .....	10-172
<b>Bases</b> .....	10-173
<b>Modifications and Accessories</b>	
Contact Blocks.....	10-175
Knobs & Caps.....	10-176
Boots & Guards.....	10-177
Plugs & Locking Attachments.....	10-178
Miscellaneous.....	10-179
Replacement Lamps.....	10-180
Legend Plates.....	10-181
<b>Approximate Dimensions</b> .....	10-183

### Description

#### Application

When properly mounted in a Type 7 & 9 enclosure, Bulletin 800H Type 7 & 9 operators are designed to meet the requirements of the National Electrical Code for Class I, Divisions 1 & 2, Groups B, C & D Hazardous Gas; Class II, Divisions 1 & 2, Groups E, F and G Hazardous Dust; and, Class III Hazardous Fiber Locations. In addition, the single gang shallow base, Cat. No. 800H-IHZX7, meets Class I, Group B requirements. This Type 7 & 9 equipment is listed by Underwriters Laboratories, Inc.

#### Per National Electrical Code:

**Zone 1.** In Class I, Zone 1 locations, all wiring methods permitted for Class I, Division 1 locations and Class I, Zone 0 or Zone 1 locations, including requirements for sealing, shall be permitted.

**Zone 2.** In Class I, Zone 2 locations, all wiring methods permitted for Class I, Division 2, Class I, Division 1 or Division 2, and Class I, Zone 0 or Zone 1 locations, including requirements for sealing, shall be permitted.

#### Operator Construction

The Allen-Bradley line of hazardous location devices features copper-free (less than 0.4 of 1% copper content) die cast aluminum bushings and mounting rings, Type #316 stainless steel operating shafts and an O-ring seal for added corrosion resistance. These components mount into a threaded hole (3/4 in.-14 NPSM) in a suitable enclosure.

Bulletin 800H Type 7 & 9 components are available in two basic formats: standard barrel (Bulletin 800H) and long barrel (Bulletin 800HL). Standard barrel devices are suitable for mounting in panel thickness up to 1 in.; Long barrel devices are suitable for mounting in panel thickness greater than 1 in. and no thicker than 2-1/2 in. Both style operators offer a unique locking bracket which provides an anti-turn feature to guard against loosening. The mounting rings in front of the panel are knurled to provide a second means of tightening each unit into the panel.

#### Outdoor Use

Bulletin 800H Type 7 & 9 stations and enclosures are not configured for outdoor use as standard. A Type 3 rating is available, while maintaining Type 7 & 9 integrity of the enclosure, by the addition of a Type 3 sealing flange and an approved drain. The sealing flange shown below may be purchased as an option or as an accessory. A Type 4 rating can be achieved by using sealing nuts to seal the push button operators in addition to using the sealing flange. Sealing nuts are available as accessories (see page 10-179.)

#### Elimination of Conduit Seal Off Requirement

Bulletin 800H Type 7 & 9 units may be installed with a variety of sealing options. By utilizing either a sealing well or flanged sealing well, these stations may be installed without a conduit seal off in most applications (subject to applicable codes and laws). The sealing wells shown below may be purchased as an option or as an accessory. Sealing wells are also available with an integral Type 3 flange seal for outdoor applications.

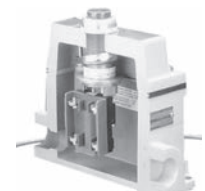
Sealed switch contact blocks are another way to eliminate the need for conduit seal fittings in most applications (subject to applicable codes and laws). Sealed switch contact blocks may be purchased as an option on assembled stations by changing the Bulletin No. from 800H to 800R. Sealed switch contact blocks can be ordered as an accessory (see page 10-175). A push button station with a sealed switch contact block is shown below.



Type 3 Flange Seal



Sealing Wells



Sealed Switch Contact Blocks



**Specifications\***

Electrical Ratings	
Contact Ratings	Refer to the contact ratings tables below.
Dielectric Strength	2200V for one minute, 1300V for one minute (Logic Reed)
Electrical Design Life Cycles	1 000 000 at max. rated load, 200 000 at max. rated load (Logic Reed)
Mechanical Ratings	
Vibration	10...2000 Hz 1.52 mm displacement (peak-to-peak) Max./10 G Max. (except Logic Reed)
Shock	1/2 cycle sine wave for 11 ms ≥ 25 G (contact fragility) and no damage at 100 G
Degree of Protection	Type 7 & 9 Explosion Proof (Type 3 and Type 4 ratings available with accessories)
Mechanical Design Life Cycles	
Push Buttons	250 000 minimum
Potentiometers	100 000 minimum
All other devices	200 000 minimum
Contact Operation	Shallow and mini contact blocks: slow double make and break Logic Reed & sealed switch contact blocks: snap-action
Wire Gauge/Terminal Screw Torque	# 18...12 AWG/6...8 lb•in
Typical Operating Forces	
Operators without contact blocks:	Flush, extended, standard mushroom, jumbo mushroom: 2.9 lb max. Jumbo and extended aluminum mushroom head: 3.95 lb maximum Maintained selector switch: 4.0 in•lb maximum
Spring Return Selector Switches:	5 in•lb to stop, 0.2 in•lb to return
Illuminated Push Buttons and Push-to-Test Pilot Lights	5.6 lb maximum
2-Position Push-Pull	9 lb maximum push or pull
3-Position Push-Pull	12 lb maximum push to in position or pull to center position (15 lb maximum pull to out position)
Contact Blocks:	
800T-XA	1 lb
Logic Reed	1 lb maximum
Sealed Switch	3 lb maximum at 0.205 in. plunger travel
Stackable Sealed Switch	1 lb maximum
Environment	
Temperature Range	Operating: -4...+13 °F (-20...+55 °C) Storage: -40...+185 °F (-40...+85 °C)
<b>Note:</b> Operating temperatures below freezing are based on the absence of freezing moisture and liquids.	
Humidity	50% at +104 °F (+40 °C)

\* Performance Data — See page Important-3.

\* External thread major diameter: 1.034 in. max., 1.024 in. min. Internal thread minor diameter: 0.958 in. min., 0.970 in. max.

**Standard Contact Ratings**

Maximum thermal continuous current  $I_{th}$  10 A AC/2.5 A DC.  
 Bulletin 800H Type 7 & 9 units with 800T-XA contacts have ratings as follows:

Max. Oprtnl. Volts $U_e$	Utilization Category		Rated Operational Currents		
	IEC	NEMA	Volts $U_e$	Make	Break
AC 600	AC-15	A600	120...600	7200VA	720VA
			72...120	60 A	720VA
			24...28*	60 A	10 A
DC 600	DC-13	Q600	28...600	69VA	
			24...28*	2.5 A	

\* For applications below 24V and 24 mA, PenTUFF™, Logic Reed or stackable sealed switch contacts are recommended.

**Sealed Switch Contact Ratings**

Maximum continuous current  $I_{th}$  5 A.

Max. Oprtnl. Volts $U_e$	Utilization Category		Rated Operational Currents		
	IEC	NEMA	Volts $U_e$	Make	Break
AC 600	AC-15	B600	120...600	3600VA	360VA
			0...120	30 A	3 A
DC 300	DC-13	P300	24...300	138VA	
			0...24	5.0 A	

**Stackable Sealed Switch Contact Ratings**

Maximum continuous current  $I_{th}$  3 A. Bulletin 800T units have control circuit ratings with sealed switch contact blocks as follows:

Max. Oprtnl. Volts $U_e$	Utilization Category		Rated Operational Currents		
	IEC	NEMA	Volts $U_e$	Make	Break
AC 300	AC-15	C300	120...300	1800VA	180VA
			0...120	15 A	1.5 A
DC 150	DC-13	Q150	24...150	69VA	
			0...24	2.5 A	

**Logic Reed Contact Ratings**

Maximum: 150V AC, 0.15 A, 8 VA and 30V DC, 0.06 A, 1.8 VA.

Should only be used with resistive loads.

**PenTUFF™ (Low Voltage) Contact Ratings**

Minimum DC: 5V, 1 mA

Maximum thermal continuous current  $I_{th}$  2.5 A AC/1.0 A DC.





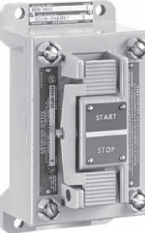






Bulletin 800H units with 800T-XAV contacts have ratings as follows:

Max. Oprtnl. Volts $U_e$	Utilization Category		Rated Operational Currents		
	IEC	NEMA	Volts $U_e$	Make	Break
AC 300	AC-15	C300	120...300	1800VA	180VA
			0...120	15 A	1.5 A
DC 150	DC-13	R150	24...150	28VA	
			0...24	1.0 A	

# Hazardous Location Push Buttons

## Product Selection

### Complete Assembled Stations (Supplied with 3/4 in. Dead End Conduit Entry — Cat. No. 800H-1HZX7)

	Operator	Contact Symbol	Contact Action	Legend Marking	Lever Type Actuator*‡	Component Type Buttons*‡
					Cat. No.	Cat. No.
 <b>Cat. No. 800H-1HA7</b>	One Push Button	 1 N.O. 1 N.C.	Momentary	STOP	800H-1HA7	800H-1HA7P
				START	800H-1HB7	800H-1HB7P
				JOG	800H-1HJ7	800H-1HJ7P
				No Legends	800H-1HX7	800H-1HX7P
 <b>Cat. No. 800H-2HA7P</b>	Two Push Buttons	 1 N.O. 1 N.C. Each Button	Momentary	START STOP	<b>800H-2HA7</b>	<b>800H-2HA7P</b>
				FOR REV	800H-2HB7	800H-2HB7P
				RAISE LOWER	800H-2HD7	800H-2HD7P
				OPEN CLOSE	800H-2HF7	800H-2HF7P
				No Legends	800H-2HX7	800H-2HX7P
 <b>Cat. No. 800H-2HAM7</b>	2-Position Selector Switch	 1 N.O. 1 N.C.	Maintained	START STOP	<b>800H-2HAM7</b>	—
				ON OFF	800H-2HCM7	800H-R2HC7
				OPEN CLOSE	800H-2HGM7	800H-R2HG7
				RUN STOP	800H-2HJM7	—
				HAND AUTO	800H-2HLM7	800H-R2HA7
				No Legends	800H-2HXM7	800H-R2HX7
 <b>Cat. No. 800H-R3HA7</b>	3-Position Selector Switch	 1 N.O. 1 N.C.	—	HAND OFF AUTO	—	<b>800H-R3HA7</b>
				No Legends	—	800H-R3HX7
 <b>Cat. No. 800H-2HAD10R7</b>	One Pilot Light, Dual Push Buttons	 120V AC/DC Full Volt./Red	—	No Legend START STOP	—	<b>800H-2HAD10R7</b>
				 1 N.O. 1 N.C.	Marking other than listed - consult your local Allen-Bradley distributor	—

\* Operators have integral padlocking attachment.

\* STOP is extended red, START is flush green, all others are flush black.

‡ Supplied with standard shallow contact blocks. For stations with sealed switch contacts, change Bulletin number from 800H to 800R. A deep enclosure is required.



**Momentary Contact Push Button Units, Non-Illuminated**



*Flush Head Unit  
 Cat. No. 800H-AP1A*



*Extended Head Unit  
 Cat. No. 800H-BP6B*

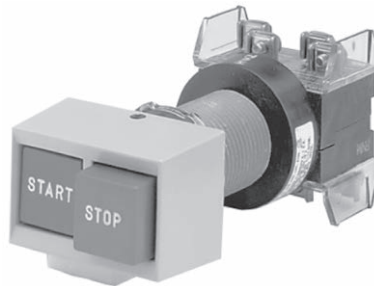


*Mushroom Head Unit  
 Cat. No. 800H-DP6A*

Contact Type	Button Color	Flush Head	Extended Head	Mushroom Head
		Cat. No.*	Cat. No.*	Cat. No.*
No Contact	Green	800H-AP1	800H-BP1	800H-DP1
	Black	<b>800H-AP2</b>	800H-BP2	800H-DP2
	Red	800H-AP6	800H-BP6	800H-DP6
1 N.O.	Green	<b>800H-AP1D1</b>	800H-BP1D1	800H-DP1D1
	Black	<b>800H-AP2D1</b>	<b>800H-BP2D1</b>	800H-DP2D1
	Red	800H-AP6D1	800H-BP6D1	800H-DP6D1
1 N.C.	Green	800H-AP1D2	800H-BP1D2	800H-DP1D2
	Black	800H-AP2D2	800H-BP2D2	800H-DP2D2
	Red	800H-AP6D2	<b>800H-BP6D2</b>	800H-DP6D2
1 N.O. - 1 N.C.	Green	<b>800H-AP1A</b>	800H-BP1A	800H-DP1A
	Black	<b>800H-AP2A</b>	800H-BP2A	800H-DP2A
	Red	<b>800H-AP6A</b>	<b>800H-BP6A</b>	<b>800H-DP6A</b>
2 N.O. - 2 N.C.	Green	800H-AP1B	800H-BP1B	800H-DP1B
	Black	800H-AP2B	800H-BP2B	800H-DP2B
	Red	800H-AP6B	800H-BP6B	800H-DP6B

\* For long barrel versions, add an **L** to the cat. no. **Example:** Cat. No. 800HL-AP1.

**Dual Momentary Contact Push Button Units**



*Dual Push Button Unit  
 Cat. No. 800H-DPH16AAXX64*

Contact Arrangement		Legend Marking		Cat. No.*
Type	Contacts	Left	Right	
2 N.O. - 2 N.C.		START (Flush/Green)	STOP (Extended/Red)	<b>800H-DPH16AAXX64</b>
		ON (Flush/Black)	OFF (Flush/Black)	800H-DPH22AAXX50
	OPEN (Flush/Black)	CLOSE (Flush/Black)	800H-DPH22AAXX57	
	UP (Flush/Black)	DOWN (Flush/Black)	800H-DPH22AAXX66	
	Blank (Flush/Black)	Blank (Flush/Black)	800H-DPH22AAXX	

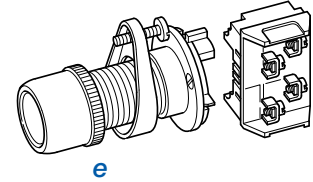
\* For long barrel versions, add an **L** to the cat. no. **Example:** Cat. No. 800HL-DPH16AAXX64.

# Hazardous Location Push Buttons

## Product Selection

### Momentary Contact Push Button Units, Non-Illuminated

800    H    -    AP       1          A  
           *a*        *b*                    *c*        *d*                    *e*



**a**

Barrel Type	
Code	Description
H	Standard barrel length
HL	Long barrel

**b**

Operator Type	
Code	Description
AP	Flush head
BP	Extended head
DP	Mushroom head
DPX	Mushroom head less color cap

**c**

Color Cap	
Code	Description
Blank	Used only when ordering operator type DPX (Table b)
1	Green
2	Black
3	Orange
4	Grey
6	Red
7	Blue
9	Yellow

**d**

Special Mushroom Head	
Code	Description
Blank	No special head
J	Jumbo mushroom head — plastic
L	Jumbo mushroom head — metal

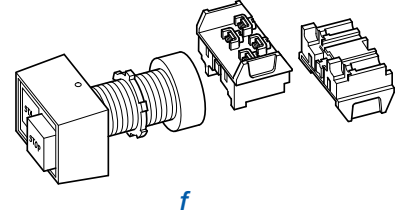
**Note:** Special mushroom head options only apply to mushroom head operator type DP (Table b).

**e**

Contact Block(s)*	
Standard	
Code	Description
Blank	No contacts
D1	1 N.O.
D2	1 N.C.
D5	1 N.O. (Mini)
D6	1 N.C. (Mini)
A2	2 N.O.
A4	2 N.C.
A	1 N.O. - 1 N.C.
B	2 N.O. - 2 N.C.
H	3 N.O. - 3 N.C.
C	4 N.O. - 4 N.C.
PenTUFF (Low Voltage)	
Code	Description
D1V	1 N.O.
D2V	1 N.C.
AV	1 N.O. - 1 N.C.
BV	2 N.O. - 2 N.C.
HV	3 N.O. - 3 N.C.
CV	4 N.O. - 4 N.C.

### Dual Push Button Units

800    H    -    DP       H       16    AAXX    64  
           *a*        *b*                    *c*        *d*                    *e*                    *f*



**a**

Barrel Type	
Code	Description
H	Standard barrel
HL	Long barrel

**b**

Operator Type	
Code	Description
DP	Dual push button

**d**

Color of Button	
Code	Description
16	Left green flush/right red extended
22	Left black flush/right black flush

**e**

Contact Block(s)*		
Code	Contact Arrangement	
	Left button for horizontal Top button for vertical	Right button for horizontal Bottom button for vertical
AAXX	1 N.O. - 1 N.C.	1 N.O. - 1 N.C.
AAAA	2 N.O. - 2 N.C.	2 N.O. - 2 N.C.

**f**

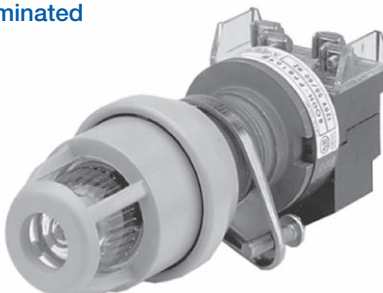
Marking		
Code	Description	
	Left button for horizontal Top button for vertical	Right button for horizontal Bottom button for vertical
Blank	No mark specified	No mark specified
64	START	STOP
50	ON	OFF
51	FORWARD	REVERSE
57	OPEN	CLOSE
66	UP	DOWN
99*	Marking specified	Marking specified

**c**

Mounting	
Code	Description
H	Horizontal
B	Vertical

\* For sealed switch and Logic Reed contact blocks, see page 10-175.  
 \* To order with special marking, specify marking; seven characters maximum per button, single line only.

## Momentary Contact Push Button Units, Illuminated



**Extended Head with Guard**  
Cat. No. 800H-PPB16M

Type	Lamp	Supply Voltage	Lens Color*	Extended Head with Guard
				Cat. No.†‡
Operator only ➤				800H-QPB00XX
Full Voltage	Incandescent	24V AC/DC	Multi-color kit	<b>800H-QPB24M</b>
		120V AC/DC		<b>800H-QPB10M</b>
	No lamp	0...250V AC/DC	No lens	800H-QPBN25
Universal	LED	12...130V AC/DC	Multi-color kit	800H-QPBH2M
Transformer	Incandescent	120V AC 50/60 Hz	Multi-color kit	800H-PPB16M
	LED			800H-PPBH16M
	No lamp		No lens	800H-PPBN16

\* Units ship with multi-color insert packet including amber, blue, green, red, and white.

† For long barrel versions, add an **L** to the cat. no. **Example:** Cat. No. 800HL-QPB2M.

‡ Includes as standard one Cat. No. 800T-XA (1 N.O./1 N.C.) contact block.

➤ Operator only supplied without power module, lamp, lens cap, or contact blocks.

## Potentiometer Units‡



**Potentiometer Unit**  
Cat. No. 800H-UP24

Resistance	Potentiometer*	Resistance	Potentiometer*
	Cat. No.‡		Cat. No.‡
Operator Only (without Resistive Element)	800H-NP37*	2.5 kΩ	<b>800H-UP19</b>
		5 kΩ	<b>800H-UP24</b>
1 kΩ	<b>800H-UP13</b>	10 kΩ	<b>800H-UP29</b>

\* Rated for 300V AC/DC, 2W maximum.

† For use with Type J potentiometers having a shaft length of 7/8 in. (22.2 mm) and a shaft diameter of 1/4 in. (6.3 mm).

‡ Single-turn operation with 312° rotation.

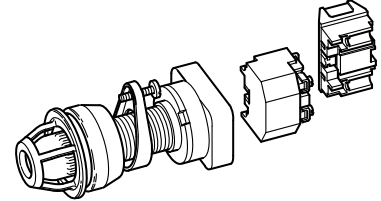
‡ For long barrel versions, add an **L** to the cat. no. **Example:** Cat. No. 800HL-UP13.

# Hazardous Location Push Buttons

## Product Selection

### Momentary Contact Push Button Units, Illuminated

800      H   -   PPB        H        16        M              
           *a*        *b*                    *c*            *d*            *e*            *f*



**a**

Operator Type	
Code	Description
H	Standard barrel length
HL	Long barrel

**b**

Power Module Type	
Code	Description
PPB	Transformer (or dual input)
QPB	Full voltage/Universal

**c**

Illumination Options	
Code	Description
Blank	Incandescent
H	LED
Dual Input	
D	Diode type, incandescent§
T	Transformer — relay type, incandescent
TH	Transformer — relay type, LED

**d**

Voltage	
Transformer	
Code	Description
16	120V AC 50/60 Hz
26	240V AC 50/60 Hz
46	480V AC 50/60 Hz
56	600V AC 50/60 Hz
Full Voltage — Incandescent	
24	24V AC/DC
10	120V AC/DC
20	240V AC/DC
Universal — LED	
2	12...130V AC/DC
Dual Input	
16	120V AC
24	24V AC/DC‡

**e**

Lens Color	
Code	Color
Blank	No lens, with standard contacts 1 N.O. - 1 N.C.
X	No lens if ordering any contacts other than standard 1 N.O. - 1 N.C.
M	Multi-color*

**f**

Contact Block(s) †	
Standard	
Code	Description
Blank	1 N.O. - 1 N.C.
X	No contacts
D1	1 N.O.
D2	1 N.C.
A2	2 N.O.
A4	2 N.C.
PenTUFF (Low Voltage)	
Code	Description
D1V	1 N.O.
D2V	1 N.C.
AV	1 N.O. - 1 N.C.

§ Diode type dual input provides circuit isolation via opposing diodes. Not recommended for use with solid-state outputs and neon indicators.

‡ Dual input diode only.

\* Multi-color insert packet includes amber, blue, green, red, and white.






† For sealed switch and Logic Reed contact blocks, see page 10-175.



**2-Position Push-Pull Units, Non-Illuminated**



**2-Position Push-Pull**  
 Cat. No. 800H-FPX6A5

Contact Type	Operator Position			Button Color	Push-Pull Cat. No.*
	 Maintained	 Maintained			
	Out	In			
 N.C.L.B.	X	O		Red	<b>800H-FPX6D4</b>
 N.O. - N.C.L.B.	O	X		Red	<b>800H-FPX6A1</b>
 N.C.L.B. - N.C.L.B.	X	O		Red	<b>800H-FPX6A5</b>





Note: X = Closed/O = Open

\* For long barrel versions, add an **L** to the cat. no. **Example:** Cat. No. 800HL-FPX6D4.





**3-Position Push-Pull Units, Non-Illuminated**



**3-Position Push-Pull**  
 Cat. No. 800H-FPXM6A7

Contact Type	Operator Position			Button Color	Push-Pull Cat. No.*
	 Momentary	 Maintained	 Maintained		
	Out	Center	In		
 N.C. - N.C.L.B.	X X	O X	O O	Red	800H-FPXM6A7

Contact Type	Operator Position			Button Color	Push-Pull Cat. No.*
	 Momentary	 Maintained	 Momentary		
	Out	Center	In		
 N.C. - N.C.L.B.	X X	O X	O O	Red	800H-FPXM6A7

Note: X = Closed/O = Open

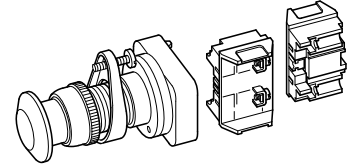
\* For long barrel versions, add an **L** to the cat. no. **Example:** Cat. No. 800HL-FPXM6A7.

# Hazardous Location Push Buttons

## Product Selection

### 2-Position Push-Pull Units, Non-Illuminated

800      H   -   FPX              1        A1    
           a            b            c            d            e



**a**

Barrel Type	
Code	Description
H	Standard barrel length
HL	Long barrel



**d**

Color Cap	
Code	Color
Blank	No cap
1	Green
2	Black
4	Grey (silver)
6	Red
7	Blue
9	Yellow (gold)

**b**

Operator Type	
Code	Description
FPX	Push-pull unit

**e**

Contact Block(s)			
Standard			
Code	Operator Position		Description
	 Out	 In	
Blank	—	—	No contacts
A1	O X	X O	1 N.O. - 1 N.C.L.B.*
A5	X X	O O	2 N.C.L.B.*
D1	O	X	1 N.O.
D4	X	O	1 N.C.L.B.*
PenTUFF (Low Voltage)			
D1V	O	X	1 N.O.
AV	O X	X O	1 N.O. - 1 N.C.

**Note:** X = Closed/O = Open.

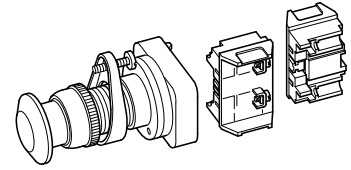
**c**

Head Type	
Code	Description
Blank	Mushroom head
J	Jumbo mushroom head*

\* Normally closed late break contact. When button is pushed from the OUT to the IN position, the mechanical detent action of the operator occurs before electrical contacts change state. When the button is pulled from the IN to the OUT position, the electrical contacts change state before the mechanical detent occurs.

### 3-Position Push-Pull Units, Non-Illuminated




800      H   -   FPX              M        1        A7    
           a            b            c            d            e            f



**a**

Barrel Type	
Code	Description
H	Standard barrel length
HL	Long barrel




**d**

Code	Operator Function		
	Operator Position		
	 Out	 Center	 In
M	Momentary	Maintained	Maintained
N	Momentary	Maintained	Momentary

**b**

Operator Type	
Code	Description
FPX	Push-pull unit

**f**

Contact Block(s)				
Standard				
Code	Operator Position			Description
	 Out	 Ctr.	 In	
Blank	—	—	—	No contacts
A	O X	O O	X O	1 N.O. - 1 N.C.
A1	O X	O X	X O	1 N.O. - 1 N.C.L.B.
A7	X X	O X	O O	1 N.C. - 1 N.C.L.B.
B6	X X	O X	O O	2 N.C. - 2 N.C.L.B.
PenTUFF (Low Voltage)				
AV	O X	O O	X O	1 N.O. - 1 N.C.

**Note:** X = Closed/O = Open.

**c**

Head Type	
Code	Description
Blank	Mushroom head
J	Jumbo mushroom head*

**e**

Color Cap	
Code	Color
Blank	No cap
1	Green
2	Black
4	Grey (silver)
6	Red
7	Blue
9	Yellow (gold)

\* Not valid with color cap option **Blank** (no cap).

2-Position Push-Pull Units, Illuminated



**Illuminated 2-Position Push-Pull**  
 Cat. No. 800H-FPXP16RA1

Type	Lamp Type	Supply Voltage	Lens Color*	Contacts	Operator Position		Cat. No.*
					Maintained Out	Maintained In	
Operator only ‡					No contacts		800H-FPXQ00
Full voltage	Incandescent	24V AC/DC	Multi-color kit	N.O. - N.C.L.B.	O	X	800H-FPXQ24MA1
		120V AC/DC			X	O	<b>800H-FPXQ10MA1</b>
	No lamp	0...250V AC/DC	No lens	No contacts		800H-FPXQN25	
Universal	LED	12...130V AC/DC	Multi-color kit	N.O. - N.C.L.B.	O X	X O	800H-FPXQH2MA1
Transformer	Incandescent	120V AC, 50/60 Hz	Multi-color kit	N.O. - N.C.L.B.	O	X	800H-FPXP16MA1
	LED				X	O	800H-FPXP16MA1
	No lamp		No lens	No contacts			

Note: X = Closed/O = Open.

3-Position Push-Pull Units, Illuminated



**Illuminated 3-Position Push-Pull**  
 Cat. No. 800H-FPXM16RA7

Operator Position (800H-FPXM)				Operator Position (800H-FPXN)			
Momentary		Maintained	Maintained	Momentary		Maintained	Momentary
Contacts	Out	Center	In	Contacts	Out	Center	In
N.C. - N.C.L.B.	X	O	O	N.C. - N.C.L.B.	X	O	O
	X	X	O		X	X	O

Type	Lamp Type	Supply Voltage	Lens Color*	Cat. No.*	Cat. No.*
Operator only ‡				800H-FPXMQ00	800H-FPXNQ00
Full voltage	Incandescent	24V AC/DC	Multi-color kit	800H-FPXMQ24MA7	800H-FPXNQ24MA7
		120V AC/DC		<b>800H-FPXMQ10MA7</b>	<b>800H-FPXNQ10MA7</b>
	No lamp	0...250V AC/DC	No lens	800H-FPXMQN25	800H-FPXNQN25
Universal	LED	12...130V AC/DC	Multi-color kit	800H-FPXMQH2MA7	800H-FPXNQH2MA7
Transformer	Incandescent	120V AC, 50/60 Hz	Multi-color kit	800H-FPXM16MA7	800H-FPXN16MA7
	LED			800H-FPXM16MA7	800H-FPXN16MA7
	No lamp		No lens	800H-FPXM16	800H-FPXN16

Note: X = Closed/O = Open

\* Units ship with multi-color insert packet including amber, blue, green, red, and white.

‡ For long barrel versions, add an L to the cat. no. Example: Cat. No. 800HL-FPXQH2MA1.

‡ Operator only supplied without power module, lamp, lens cap, or contact blocks.

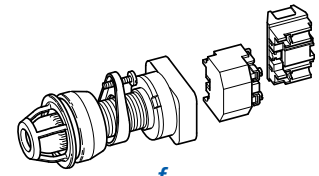


# Hazardous Location Push Buttons

## Product Selection

### 2- and 3-Position Push-Pull Units, Illuminated

800      H   -   FPX        PH        16        M        A1    
           a            b            c            d            e            f            g



**a**

Barrel Type	
Code	Description
H	Standard barrel length
HL	Long barrel

**b**

Operator Type	
Code	Description
FPX	Push-pull unit

**c**

Operator Function			
2-Position			
Code	Description		
Blank	Push-pull		
3-Position			
Code	Operator Position		
M	Mom.	Main.	Main.
N	Mom.	Main.	Mom.

**Note:** Mom. - Momentary  
Main. - Maintained

**d**

Illumination Options	
Transformer	
Code	Description
P	Incandescent
PH	LED
Full Voltage	
Code	Description
Q	Incandescent
QH	Universal LED
Dual Input	
Code	Description
D	Dual input — diode§
DT	Dual input — transformer relay
DTH	Dual input transformer — relay LED

**e**

Voltage	
Transformer	
Code	Description
16	120V AC 50/60 Hz
26	240V AC 50/60 Hz
46	480V AC 50/60 Hz
56	600V AC 50/60 Hz
Full Voltage — Incandescent	
Code	Description
24	24V AC/DC
10	120V AC/DC
20	240V AC/DC
Universal — LED	
Code	Description
2	12...130V AC/DC
Dual Input	
Code	Description
16	120V AC
24	24V AC/DC+

**f**

Color Cap	
Code	Color
Blank	No lens with no contacts
X	No lens with contacts
M	Multi-color*

**g**

Contact Blocks	
Standard	
Code	Color
Blank	No contacts
D1	1 N.O.
D4	1 N.C.L.B.‡
A	1 N.O. - 1 N.C.
A1	1 N.O. - 1 N.C.L.B.‡
A2	2 N.O.
A5	2 N.C.L.B.
A7	1 N.C. - 1 N.C.L.B.‡
PenTUFF (Low Voltage)	
Code	Description
D1V	1 N.O.
D2V	1 N.C.
AV	1 N.O. - 1 N.C.
Logic Reed	
Code	Color
D1R	1 N.O.
D2R	1 N.C.
AR	1 N.O. - 1 N.C.
A2R	2 N.O.
A4R	2 N.C.

Table 1. Target Selection

g Code	2-Position		Contact Description	3-Position			g Code
A, AV, R	O X	X O	N.O. N.C.	O X	O O	X O	A, AV, AR
A1	O X	X O	N.O. N.C.L.B.	O X	O X	X O	A1
A2	O X	O X	N.O. N.O.	— —	— —	— —	—
A5	X O	X O	N.C.L.B. N.C.L.B.	— —	— —	— —	—
—	— —	— —	N.C. N.C.L.B.	X X	O X	O O	A7
D1, D1V, D1R	O	X	N.O.	—	—	—	—
D4	X	O	N.C.L.B.	—	—	—	—

10

\* Multi-color insert packet includes amber, blue, green, red, and white.

§ Diode type dual input provides circuit isolation via opposing diodes. Not recommended for use with solid-state outputs and neon indicators.

‡ Normally closed late break contact. When button is pushed from the OUT to the IN position, the mechanical detent action of the operator occurs before electrical contacts change state. When the button is pulled from the IN to the OUT position, the electrical contacts change state before the mechanical detent occurs.

+ Dual input diode only.

**2-Position Selector Switch Units, Non-Illuminated**



Standard Knob Operator  
 Cat. No. 800H-HP2KB6AXXX



Knob Lever Operator  
 Cat. No. 800H-HP17KB6AXXX



Metal Wing Lever Operator  
 Cat. No. 800H-HP11KB6AXXX

Contact Type	Operator Position		Contact Action M = Maintained S = Spring Return	Standard Knob	Knob Lever	Wing Lever
				Cat. No.‡	Cat. No.‡	Cat. No.‡
No Contacts	—	—	M M	<b>800H-HP2KB6</b>	800H-HP17KB6	800H-HP11KB6
			S→M*	800H-HP4KL8	800H-HP4KL8	800H-HP4KL8
1 N.O.	O	X	M M	<b>800H-HP2KB6DXXX</b>	800H-HP17KB6DXXX	800H-HP11KB6DXXX
			S→M*	800H-HP4KL8DXXX	800H-HP18KL8DXXX	800H-HP15KL8DXXX
			M←S	800H-HP5KL8DXXX	800H-HP19KL8DXXX	800H-HP16KL8DXXX
1 N.O. - 1 N.C.	O X	X O	M M	<b>800H-HP2KB6AXXX</b>	800H-HP17KB6AXXX	800H-HP11KB6AXXX
			S→M*	800H-HP4KL8AXXX	800H-HP18KL8AXXX	800H-HP15KL8AXXX
			M←S	800H-HP5KL8AXXX	800H-HP19KL8AXXX	800H-HP16KL8AXXX
2 N.O. - 2 N.C.	O X O X	X O X O	M M	<b>800H-HP2KB6AAXX</b>	800H-HP17KB6AAXX	800H-HP11KB6AAXX
			S→M*	800H-HP4KL8AAXX	800H-HP18KL8AAXX	800H-HP15KL8AAXX
			M←S	800H-HP5KL8AAXX	800H-HP19KL8AAXX	800H-HP16KL8AAXX

Note: X = Closed/O = Open



2-Position Cylinder Lock Operator  
 Cat. No. 800H-HP31KB6AXXX

Contact Type	Operator Position		Contact Action M = Maintained S = Spring Return	Cylinder Lock		
				Key Removal Left*	Key Removal Right*	Key Removal Both*
				Cat. No.‡	Cat. No.‡	Cat. No.‡
No Contacts	—	—	M M	800H-HP31KB6	800H-HP32KB6	800H-HP33KB6
			M←S	800H-HP48KL8	—	—
1 N.O.	O	X	M M	800H-HP31KB6DXXX	800H-HP32KB6DXXX	800H-HP33KB6DXXX
			S→M*	—	800H-HP42KL8DXXX	—
			M←S	800H-HP48KL8DXXX	—	—
1 N.O. - 1 N.C.	O X	X O	M M	<b>800H-HP31KB6AXXX</b>	800H-HP32KB6AXXX	800H-HP33KB6AXXX
			S→M*	—	800H-HP42KL8AXXX	—
			M←S	800H-HP48KL8AXXX	—	—
2 N.O. - 2 N.C.	O X O X	X O X O	M M	800H-HP31KB6AAXX	800H-HP32KB6AAXX	800H-HP33KB6AAXX
			S→M*	—	800H-HP42KL8AAXX	—
			M←S	800H-HP48KL8AAXX	—	—

Note: X = Closed/O = Open

\* Target tables are reversed from those shown.

\* Key removable from maintained positions only. Devices supplied with 2 keys. Replacement part number for standard D018 key is X-181170.

‡ For long barrel versions, add an L to the cat. no. Example: Cat. No. 800HL-HP48KL8.

# Hazardous Location Push Buttons

## Product Selection

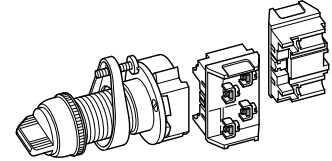
### 2-Position Selector Switch Units, Non-Illuminated

800    H    -    HP    A    2    KB6    AXXX (Knob/Wing Lever)

*a*                      *b*                      *c*                      *d*                      *e*                      *f*

800    H    -    HP    31    KB6    AXXX (Cylinder Lock)

*a*                      *b*                      *c*<sub>1</sub>                      *d*<sub>1</sub>                      *e*                      *f*



**a**

Barrel Type	
Code	Description
H	Standard barrel length
HL	Long barrel

**b**

Number of Positions	
Code	Description
HP	2-position

**c**

Knob Insert Colors*	
Code	Color
Blank	White
X	Packet of colored inserts*

Metal Wing Lever Colors	
Code	Color
A	Red
Blank	Grey

**c<sub>1</sub>**

Key Removal Position	
Maintained	
Code	Operator Function
31	Key removal — left
32	Key removal — right
33	Key removal — both

Spring Return From Left	
Code	Operator Function
42	Key removal — right ‡

Spring Return From Right	
Code	Operator Function
48	Key removal — left

**d**

Operator Type and Function	
Standard Knob	
Code	Operator Function
2	Maintained
4	Spring return from left ‡
5	Spring return from right

Knob Lever	
Code	Operator Function
17	Maintained
18	Spring return from left ‡
19	Spring return from right

Metal Wing Lever	
Code	Operator Function
11	Maintained
15	Spring return from left ‡
16	Spring return from right

**d<sub>1</sub>**

Optional Keys			
Code	D Series Key No.	Code	T Series Key No.
Blank	D018 (std. key)	15	T112
03	D020	16	T115
04	D025	17	T324
05	D335	18	T382
06	D429	19	T404
07	D461	20	T171
08	D111	21	T484
09	D587	22	T547
10	D682	23	T569
11	D713	24	T692
12	D900	25	T752
13	D992	26	T178
14	D118	—	—

**e**

Cam Option	
Code	Description
KB6	Cam for maintained operators
KL8	Cam for spring return operators

**f**

Contact Block(s)			
Standard			
Code	Contact Configuration	2-Position	
Blank	No contacts	—	—
DXXX	1 N.O.	O	X
EXXX	1 N.C.	X	O
MXXX	2 N.O.	O	X
		O	X
NXXX	2 N.C.	X	O
		X	O
AXXX	1 N.O. - 1 N.C.	O	X
		X	O
AAXX	2 N.O. - 2 N.C.	O	X
		X	O
		O	X
		X	O

PenTUFF (Low Voltage)			
Code	Contact Configuration	2-Position	
HXXX	1 N.O.	O	X
UXXX	1 N.C.	X	O
FXXX	1 N.O. - 1 N.C.	O	X
		X	O
FFXX	2 N.O. - 2 N.C.	O	X
		X	O
		O	X
		X	O

**Note:** X = Closed/O = Open.

\* Each standard and knob lever operator is factory assembled with a white insert. Other colors are available, factory assembled, if ordered in quantities of 10 or more.  
 \* One insert of each color (blue, green, orange, red, and yellow).  
 ‡ Target tables are reversed from those shown.

**3-Position Selector Switch Units, Non-Illuminated**



Standard Knob Operator  
 Cat. No. 800H-JP2KB7AXXX



Knob Lever Operator  
 Cat. No. 800H-JP17KB7AXXX



Metal Wing Lever Operator  
 Cat. No. 800H-JP11KB7AXXX

Contact Type	Operator Position			M = Maintained S = Spring Return	Standard Knob	Knob Lever	Metal Wing Lever
					Cat. No.‡	Cat. No.‡	Cat. No.‡
No Contacts	—	—	—	M M M	<b>800H-JP2KB7</b>	800H-JP17KB7	800H-JP11KB7
				S→M M	800H-JP4KB7	800H-JP18KB7	800H-JP15KB7
				M M←S	800H-JP5KB7	800H-JP19KB7	800H-JP16KB7
				S→M←S	800H-JP91KB7	800H-JP20KB7	800H-JP141KB7
	O X	O O	X O	M M M	<b>800H-JP2KB7AXXX</b>	800H-JP17KB7AXXX	800H-JP11KB7AXXX
				S→M M	800H-JP4KB7AXXX	800H-JP18KB7AXXX	800H-JP15KB7AXXX
				M M←S	800H-JP5KB7AXXX	800H-JP19KB7AXXX	800H-JP16KB7AXXX
				S→M←S	<b>800H-JP91KB7AXXX</b>	800H-JP20KB7AXXX	800H-JP141KB7AXXX
	O X O X	O O O O	X O X O	M M M	<b>800H-JP2KB7AAXX</b>	800H-JP17KB7AAXX	800H-JP11KB7AAXX
				S→M M	800H-JP4KB7AAXX	800H-JP18KB7AAXX	800H-JP15KB7AAXX
				M M←S	800H-JP5KB7AAXX	800H-JP19KB7AAXX	800H-JP16KB7AAXX
				S→M←S	800H-JP91KB7AAXX	800H-JP20KB7AAXX	800H-JP141KB7AAXX

Note: X = Closed/O = Open



3-Position Cylinder Lock Operator  
 Cat. No. 800H-JP42KB7AXXX

Contact Type	Operator Position			M = Maintained S = Spring Return	Cylinder Lock		
					Key Removal Left	Key Removal Center	Key Removal All*
					Cat. No.‡	Cat. No.‡	Cat. No.‡
No Contacts	O	X	X	M M M	800H-JP41KB7	800H-JP42KB7	800H-JP44KB7
				S→M*	—	800H-JP50KB7	800H-JP51KB7
				M←S	800H-HP5KL8DXXX	800H-JP38KB7	800H-JP73KB7
				M M	—	800H-JP631KB7	—
	O X	O O	X O	M M M*	800H-JP41KB7AXXX	800H-JP42KB7AXXX	800H-JP44KB7AXXX
				M←S	—	800H-JP50KB7AXXX	800H-JP51KB7AXXX
				M M←S	800H-JP69KB7AXXX	800H-JP38KB7AXXX	800H-JP73KB7AXXX
				S→M←S	—	800H-JP631KB7AXXX	—

Note: X = Closed/O = Open

\* Key removable in maintained positions only.

‡ For long barrel versions, add an L to the cat. no. **Example:** Cat. No. 800HL-JP41KB7.



**4-Position Selector Switch Units, Non-Illuminated**



Standard Knob Operator  
 Cat. No. 800H-NP2KF4AAXX



Knob Lever Operator  
 Cat. No. 800H-NP17KF4AAXX



Metal Wing Lever Operator  
 Cat. No. 800H-NP11KF4AAXX

Contact Type	Operator Position				M = Maintained S = Spring Return	Standard Knob	Knob Lever	Metal Wing Lever
						Cat. No.‡	Cat. No.‡	Cat. No.‡
No Contacts	—	—	—	—	M M M M	800H-NP2KF4	800H-NP17KF4	800H-NP11KF4
					S→M M M	800H-NP3KF4	800H-NP29KF4	800H-NP13KF4
					M M M←S	800H-NP9KF4	800H-NP30KF4	800H-NP14KF4
	X	O	O	O	M M M M	800H-NP2KF4AAXX	800H-NP17KF4AAXX	800H-NP11KF4AAXX
	O	X	O	O	S→M M M	800H-NP3KF4AAXX	800H-NP29KF4AAXX	800H-NP13KF4AAXX
	O	O	X	O	M M M←S	800H-NP9KF4AAXX	800H-NP30KF4AAXX	800H-NP14KF4AAXX
	O	O	O	X				

Note: X = Closed/O = Open



Cylinder Lock Operator  
 Cat. No. 800H-NP32KF4AAXX

Contact Type	Operator Position				M = Maintained S = Spring Return	Cylinder Lock		
						Key Removal Position 2	Key Removal Position 3	Key Removal All*
						Cat. No.‡	Cat. No.‡	Cat. No.‡
No Contacts	—	—	—	—	M M M M	800H-NP32KF4	800H-NP33KF4	800H-NP61KF4
					S→M M M	800H-NP132KF4	800H-NP133KF4	800H-NP154KF4
					M M M←S	800H-NP232KF4	800H-NP233KF4	800H-NP251KF4
	X	O	O	O	M M M M	800H-NP32KF4AAXX	800H-NP33KF4AAXX	800H-NP61KF4AAXX
	O	X	O	O	S→M M M	800H-NP132KF4AAXX	800H-NP133KF4AAXX	800H-NP154KF4AAXX
	O	O	X	O	M M M←S	800H-NP232KF4AAXX	800H-NP233KF4AAXX	800H-NP251KF4AAXX
	O	O	O	X				

Note: X = Closed/O = Open

\* Key removable in maintained positions only.

‡ For long barrel versions, add an **L** to the cat. no. **Example:** Cat. No. 800HL-NP32KF4.



# Hazardous Location Push Buttons

## Product Selection

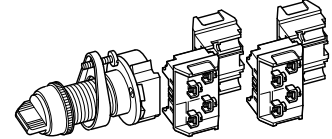
### 4-Position Selector Switch Units, Non-Illuminated

800 H - NP 2 KF4 AAXX (Knob/Wing Lever)

*a*      *b*      *c*      *d*      *e*      *f*

800 H - NP 31 KF4 AAXX (Cylinder Lock)

*a*      *b*      *c*<sub>1</sub>      *d*<sub>1</sub>      *e*      *f*



**a**

Barrel Type	
Code	Description
H	Standard barrel length
HL	Long barrel

**b**

Number of Positions	
Code	Description
NP	4-position

**c**

Knob Insert Colors*	
Code	Color
Blank	White
X	Packet of colored inserts*

Metal Wing Lever Colors	
Code	Color
A	Red
Blank	Grey

**c<sub>1</sub>**

Key Removal Position and Operator Function	
Maintained	
Code	Operator Function
31	Key removal position 1
32	Key removal position 2
33	Key removal position 3
34	Key removal position 4
61	Key removal all positions

**c<sub>1</sub> (cont'd)**

Key Removal Position and Operator Function	
Spring Return From Position 1 to Position 2	
Code	Operator Function
132	Key removal position 2
133	Key removal position 3
134	Key removal position 4
154	Key removal positions 2, 3, and 4

Spring Return From Position 1 to Position 2	
Code	Operator Function
231	Key removal position 1
232	Key removal position 2
233	Key removal position 3
251	Key removal positions 1, 2, and 3

**d**

Operator Function and Knob Type	
Standard Knob	
Code	Operator Function
2	Maintained
3	Spring return from position 1 to position 2
9	Spring return from position 4 to position 3

Knob Lever	
Code	Operator Function
17	Maintained
29	Spring return from position 1 to position 2
30	Spring return from position 4 to position 3

**d (cont'd)**

Operator Function and Knob Type	
Metal Wing Lever	
Code	Operator Function
11	Maintained
13	Spring return from position 1 to position 2
14	Spring return from position 4 to position 3

**d<sub>1</sub>**

Optional Keys§	
D Series	
Code	Description
Blank	D018 (standard key)

**e**

Cam Option	
Code	Description
KF4	F cam (standard)
KG4	G cam
KK4	K cam
KM4	M cam
KP4	P cam
KH4	Overlapping cam

**f**

Contact Block Option	
Code	Description
Blank	No contacts
AAXX	Two contact targets for a given cam as shown in the W (white side) column of Table 1 and 2 contact targets for the same cam as shown in the B (black side) column of Table 1. (One <b>Cat. No. 800T-XA</b> contact block per side. Two contact blocks total)

**f (cont'd)**

Contact Block Option	
Code	Description
AAAA	Four contact targets for a given cam as shown in the W (white side) column of Table 1 and 4 contact targets for the same cam as shown in the B (black side) column of Table 1. (Two <b>Cat. No. 800T-XA</b> contact blocks per side. Four contact blocks total.)
PenTUFF (Low Voltage)	
Code	Description
FFXX	Two contact targets for a given cam as shown in the W (white side) column of Table 1 and 2 contact targets for the same cam as shown in the B (black side) column of Table 1. (One <b>Cat. No. 800T-XAV</b> contact block per side. Two contact blocks total)
FFFF	Four contact targets for a given cam as shown in the W (white side) column of Table 1 and 4 contact targets for the same cam as shown in the B (black side) column of Table 1. (Two <b>Cat. No. 800T-XAV</b> contact blocks per side. Four contact blocks total.)

Table 1. Selector Switch Cam Targets

Contact Block Suffix Code	Contact Block Side	Circuits	Cam Description																								
			KF4		KG4		KK4*		KM4*		KP4		KN4‡														
			↻	↻	↻	↻	↻	↻	↻	↻	↻	↻	↻	↻	↻	↻	↻										
↑ AAAA FFFF ↓	↑ AAXX FFXX ↓	White	A	X	O	O	O	X	X	O	O	O	O	X	X	X	O	O	O	O	O	X	O	X	O	O	
			B	O	X	O	O	O	O	X	O	X	X	O	O	O	X	X	O	O	X	O	O	O	O	O	O
	Black	A	O	O	X	X	O	O	O	O	X	O	X	O	O	X	O	O	X	O	X	O	X	O	X	O	O
		B	O	O	X	O	O	O	O	X	O	X	X	O	O	X	O	O	X	O	O	X	O	O	X	O	O
	White	A	X	O	O	O	X	X	O	O	O	O	X	X	X	O	O	O	O	O	O	X	O	X	O	O	O
		B	O	X	O	O	O	O	X	O	X	X	O	O	O	X	X	O	O	X	O	O	O	O	O	O	X
	Black	A	O	O	O	X	X	O	O	O	X	O	O	X	O	O	O	X	O	O	X	X	O	O	X	O	O
		B	O	O	X	O	O	O	O	X	O	X	X	O	O	X	O	O	X	O	O	O	O	X	O	O	O

**Note:** W = White B = Black. X = Closed/O = Open. For additional targets and overlapping cams, see Publication 800T-2.8.

\* Each standard and knob lever operator is factory assembled with a white insert. Other colors available, factory assembled, if ordered in quantities of 10 or more.

\* One insert of each color (blue, green, orange, red, and yellow).

‡ Overlapping cam.

§ Devices supplied with 2 keys. Replacement part number for standard D018 key is X-181170

♣ Not available with wing lever operator.



## Pilot Light Units



Transformer Type Pilot Light  
Cat. No. 800H-PP16M



Push-to-Test Pilot Light  
Cat. No. 800H-PPT16M



Pigtail Pilot Light  
Cat. No. 800H-LP24M

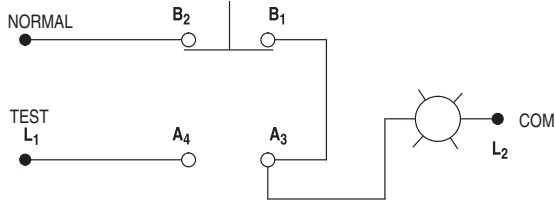
Type	Lamp Type	Supply Voltage	Lens Color*	Pilot Light	Push-to-Test	Pigtail
				Cat. No.*	Cat. No.*‡	Cat. No.*§
Operator only*				800H-QPN00	800H-QPB00XX	—
Full voltage	Incandescent	24V AC/DC	Multi-color kit	800H-QP24M	800H-QPT24M	800H-LP24M
		120V AC/DC		<b>800H-QP10M</b>	<b>800H-QPT10M</b>	<b>800H-LP10M</b>
	No lamp	No lens	800H-QPN25	800H-QPTN25	800H-LPN25	
	LED	24V AC/DC	Multi-color kit	—	—	800H-LPH24M
120V AC		—		—	800H-LPH10M	
Universal	LED	12...130V AC/DC	Multi-color kit	<b>800H-QPH2M</b>	800H-QPTH2M	—
Transformer	Incandescent	120V AC, 50/60 Hz	Multi-color kit	<b>800H-PP16M</b>	800H-PPT16M	—
	LED			800H-PPH16M	800H-PPTH16M	—

- \* Units ship with multi-color insert packet including amber, blue, green, red, and white.
- \* For long barrel versions, add an **L** to the cat. no. **Example:** Cat. No. 800HL-QPH2M
- ‡ Includes one standard Cat. No. 800T-XA (1 N.O./1 N.C.) contact block.
- § Pigtail length is 7 in.
- \* Operator only supplied without power module, lamp, lens cap, or contact blocks.

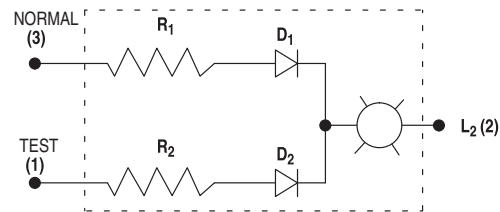
### Typical Pilot Light Wiring Diagrams

See applicable Codes and Laws.

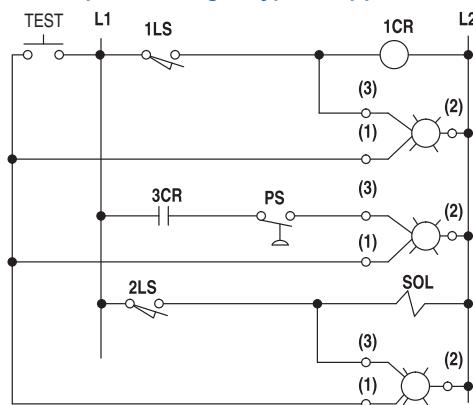
#### Push-to-Test Pilot Light Device Schematic



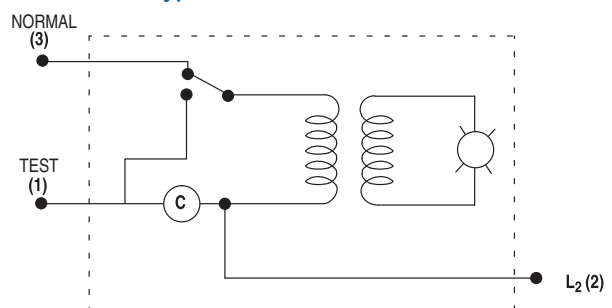
#### Dual Input Diode Pilot Device Schematic



#### Dual Input Pilot Light Typical Application Wiring Diagram



#### Dual Input Pilot Light Transformer Type Device Schematic

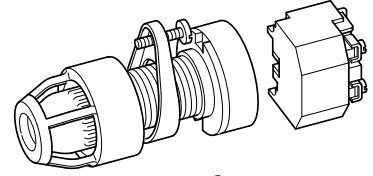


# Hazardous Location Push Buttons

## Product Selection

### Pilot Light Units

800      H   -   PP        T        d        16        M    
           a            b            c            d            e            f



**a**

Barrel Type	
Code	Description
H	Standard barrel length
HL	Long barrel

**b**

Power Module Type	
Code	Description
PP	Transformer (or dual input)
QP	Full voltage/Universal
LP	Pigtail — full voltage*
LPK	Pigtail — full voltage* (for dual push buttons)

**c**

Lamp Test Options	
Code	Description
Blank	No test option
T	Push-to-test
D	Dual input — diode†
DT	Dual input — transformer relay‡

**d**

Illumination Option	
Code	Description
Blank	Incandescent
H	LED♣

**e**

Voltage	
Transformer	
Code	Description
16	120V AC, 50/60 Hz
26	240V AC, 50/60 Hz
46	480V AC, 50/60 Hz
56	600V AC, 50/60 Hz
Full Voltage — Incandescent	
Code	Description
24	24V AC/DC
10	120V AC/DC
20	240V AC/DC
Universal — LED	
Code	Description
2	12...130V AC/DC
Dual Input	
Code	Description
16	120V AC
24	24V AC/DC♠
Pigtail	
Code	Description
24	24V AC/DC
10	120V AC/DC
20	240V AC/DC

**f**

Lens Color	
Code	Color
Blank	No lens with no contacts
M	Multi-color*

**Note:** Push-to-test pilot light is supplied with a factory jumpered 800T-XA, 1 N.O - 1 N.C contact block.

\* Multi-color insert packet includes amber, blue, green, red, and white

⊛ Lamp test options is not available with pigtail.

‡ Only available with power module type code **PP**.

♣ LED illumination option is not available with diode type dual input lamp test options.

♠ Dual input diode only.

### Ordering Information for Stations

#### Stations

Bulletin 800H Type 7 & 9 stations are available as factory assembled or as components for field assembly.

#### Factory-Assembled Stations

Bulletin 800H Type 7 & 9 control stations are designed to meet the requirements of the National Electrical Code. These stations are listed by Underwriters Laboratories, Inc. for Class I, Divisions 1 & 2, Groups C & D Hazardous Gases or Vapors, Class II, Divisions 1 & 2, Groups E, F & G Hazardous Dust and Class III Hazardous Fiber Locations. In addition the single gang shallow base, **Cat. No. 800H-IHZX7**, meets Class I, Group B requirements as defined in the National Electrical Code.

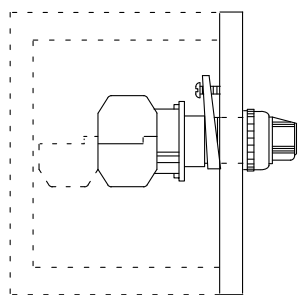
Factory-assembled stations may be ordered in three ways:

- **Standard**, factory-assembled stations listed on page 10-154.
- **Custom**, factory-assembled stations can be ordered by following the instructions listed on this page.

### Station Design Guidelines

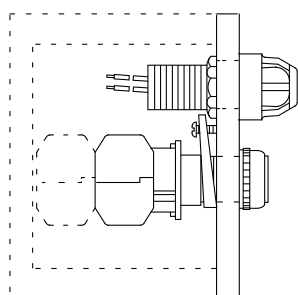
(Also see Applicable Codes and Standards)

1. Push-to-test pilot lights, illuminated push buttons, push-to-pull units, 4-position selector switches, and all operators with two contact blocks fastened along side one another or with a power module and contact block along side one another must be installed in a single hole cover.
2. Dual push button units may only be installed in a single-hole cover or the specially designed two-hole cover (Cat. No. 800H-NP33), which can accommodate the dual push button and the special pigtail pilot light (Cat. No. 800H-LPK10R).
3. When two components are installed in one cover, contact blocks are restricted to one side of the operator. Contact blocks of each operator must face each other.
4. One level of contact blocks is maximum in a shallow base or deep base when used with a sealing well. Contact blocks, except sealed switch type, may be mounted two deep in other bases.
5. If sealed switch contact blocks or a sealing well are used, a deep enclosure is required.
6.
  - a. START push buttons should be green or black flush, installed to the left or above STOP push buttons.
  - b. EMERGENCY STOP push buttons should be a red mushroom.
  - c. STOP push buttons should be red extended, installed to the right or below START push button.
  - d. STOP push buttons should be installed in the last position (bottom or right) of each unit when required.
  - e. Pilot lights should be installed in the first position (top or left side) of each unit when required.



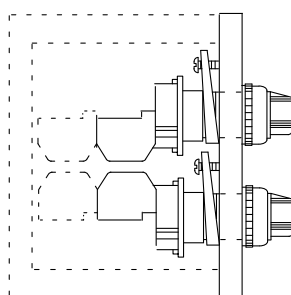
#### Design Guideline #1

Push-to-test pilot lights, illuminated push buttons, push-pull units, 4-position selector switches, all operators with two contact blocks fastened along side one another or with a power module and contact block along side one another must be installed in a single hole cover.



#### Design Guideline #2

Dual push button units may only be installed in a single hole cover or the specially designed two hole cover (Cat. No. 800H-NP33), which can accommodate the dual push button and the special pigtail pilot light (Cat. No. 800H-LPK10R).



#### Design Guideline #3

When two components are installed in one cover, contact blocks are restricted to one side of the operator. Contact blocks of each operator must face each other.

#### Design Guideline #4

One level of contact blocks is maximum in a shallow base or deep base when used with a sealing well. Contact blocks, except sealed switch type, may be mounted two deep in other bases.

### Components for Field Assembled Stations

**Eight-gang maximum\***. These 2- and 3-gang modules may be assembled into the multi-gang stations by installing a coupler kit between the enclosures. These separate bases, covers, or bases with covers are Underwriters Laboratories, Inc. listed when properly assembled. These enclosures meet the requirements of Class I, Division 1 & 2, Groups C & D, Class II, Divisions 1 & 2, Groups E, F & G, and Class III hazardous locations as defined in the National Electrical Code. Bulletin 800H Type 7 & 9 components are designed for these modular enclosures and are UL Listed for this purpose.

**Note:** Components may be assembled as multi-gang units up to an **eight-gang maximum\***.

To select components for field assembly, follow the instructions for ordering a custom-built station.

### Instructions for Ordering Custom-Built Stations

1. Select operators required from page 10-154. (If lever type, select covers from page 10-172 and go to Step 3).
2. Select covers based on mounting requirements on page 10-172.
3. Select an assembled base from page 10-173 in accordance with the number of covers selected in Step 2.
4. Select legend plates from page 10-181...10-182 (and accessories, if required, from pages page 10-175...10-179).
5. If a particular sequence of operators or mounting orientation (vertical versus horizontal) is required, include a rough sketch.

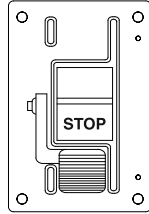
\* Flange width is designed to comply with Underwriters Laboratories standards to enclosures with an internal free volume of up to 300 cubic inches (a maximum 8-gang assembly).

# Hazardous Location Push Buttons

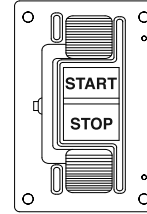
## Product Selection

### Covers, Lever Type Actuator

**Note:** Lever type covers are furnished without contact blocks. Legend plate for half lever is **STOP**; full lever momentary and maintained is a **START-STOP**. To order without legend plate, add suffix **X** to the cat. no.



Half Lever

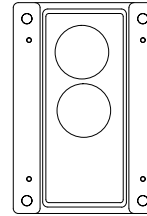
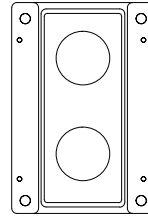
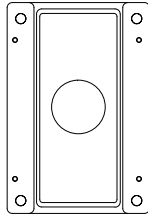
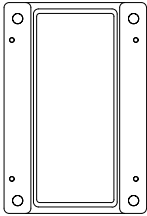


Double Lever Momentary

Half Lever	Double Lever Momentary	Double Lever Maintained	Double Lever Momentary/Maintained*
Cat. No.	Cat. No.	Cat. No.	Cat. No.
800H-NP14	<b>800H-NP15</b>	800H-NP16	800H-NP34

\* A normally open circuit configuration is recommended for use behind this momentary lever and a late break normally closed circuit configuration is required for use behind the maintained lever to achieve proper functioning of the device.

### Covers, Component Type Button



Blank	One Hole*	Two Hole†	Two Hole Special§
Cat. No.	Cat. No.	Cat. No.	Cat. No.
800H-NP32	800H-NP30	800H-NP31	800H-NP33

\* One-hole covers use a jumbo legend plate only.

† Two-hole covers use a standard legend plate only.

§ This special two-hole cover can accommodate the pigtail pilot light (**Bulletin 800H-LPK10** series), the dual push button or any non-illuminated unit. Legend plates (**Cat. No. 800H-Y140J** green and red split-field) and (**Cat. No. 800H-Y141J** grey full field), are the only legend plates suitable for use with this cover.

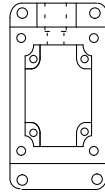
# Hazardous Location Push Buttons

## Product Selection

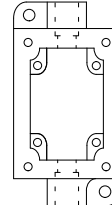
### Assembled Bases (for Field Assembly and Custom Stations)

**Enclosure Covers** — See enclosure cover tables for a complete listing of covers for these bases.

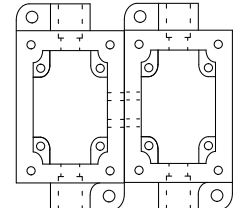
**Special Conduit Entries** — For conduit entries not listed, consult your local Rockwell Automation sales office or Allen-Bradley distributor.



**1-Gang Shallow\***

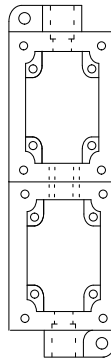


**1-Gang Deep\***

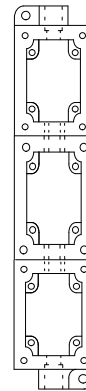


**2-Gang Horizontal\***

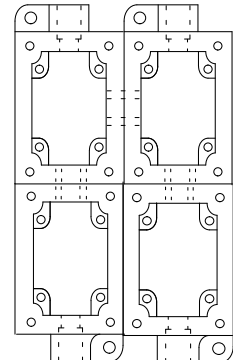
Conduit Entry	Cat. No.	Cat. No.	Cat. No.
3/4 in. Dead End	<b>800H-1HZX7</b>	<b>800H-1HVX7</b>	—
3/4 in. Feed Through	—	<b>800H-1HVX7M1</b>	—
1 in. Dead End	—	800H-1HVX7M2	<b>800H-2HHX7</b>
1 in. Feed Through	—	800H-1HVX7M3	—



**2-Gang Vertical\***

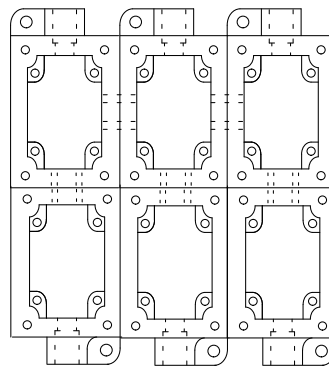


**3-Gang Vertical\***

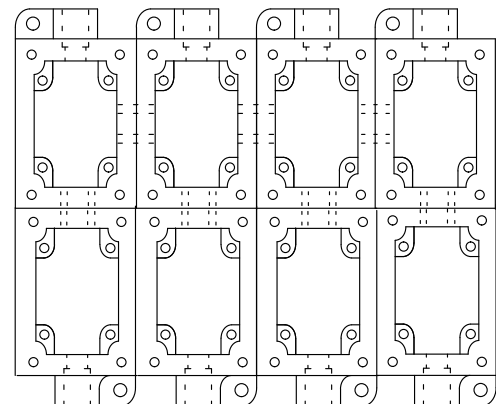


**4-Gang\***

Conduit Entry	Cat. No.	Cat. No.	Cat. No.
1 in. Feed Through	<b>800H-2HYX7</b>	800H-3HYX7	800H-4HVX7



**6-Gang\***



**8-Gang\***

Conduit Entry	Cat. No.	Cat. No.
1 in. Feed Through	<b>800H-6HVX7</b>	<b>800H-8HVX7</b>

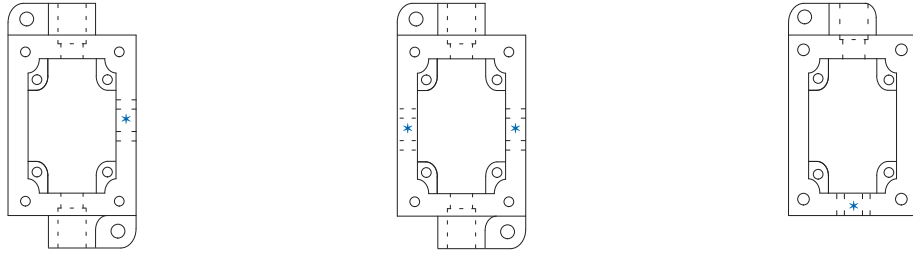
\* Shallow base cannot accommodate sealing well, sealed switched contact blocks, or stacked contact blocks. Shallow base rated for Group B.

\* Deep base can accommodate sealing well, sealed switch contact blocks, or up to 2 deep standard contact blocks.

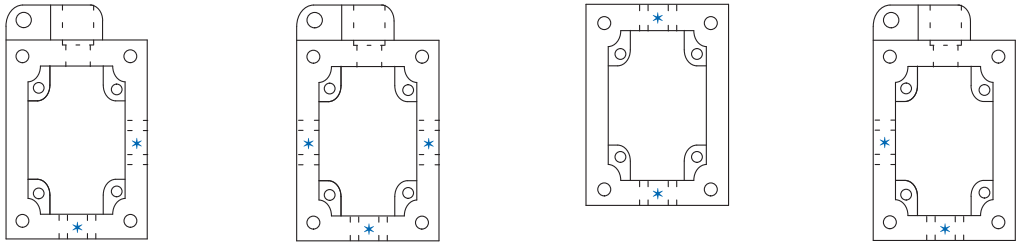
# Hazardous Location Push Buttons

## Product Selection

### Bases for Multi-Gang Stations



Conduit Sizes	Cat. No.	Cat. No.	Cat. No.
3/4 in. Feed Through	800H-NP40C	800H-NP41C	—
1 in. Feed Through	<b>800H-NP40D</b>	800H-NP41D	—
3/4 in. Dead End	—	—	800H-NP42A
1 in. Dead End	—	—	800H-NP42B



Conduit Sizes	Cat. No.	Cat. No.	Cat. No.	Cat. No.
3/4 in. Dead End	800H-NP43A	800H-NP44A	—	800H-NP46A
1 in. Dead End	800H-NP43B	<b>800H-NP44B</b>	—	800H-NP46B
None	—	—	800H-NP45	—

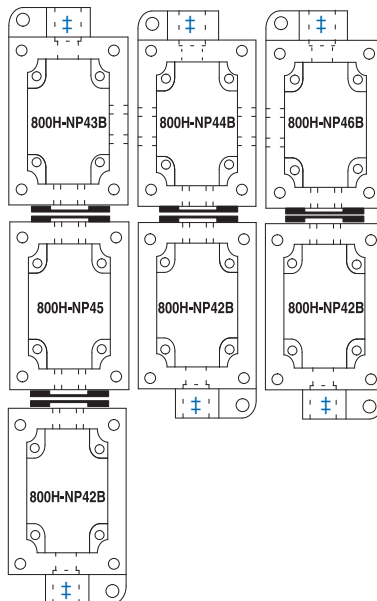
**Example:**

7-gang base with 1 in. through-feed conduit consists of:

- 3-Cat. No. **800H-NP42B**
- 1-Cat. No. **800H-NP43B**
- 1-Cat. No. **800H-NP44B**
- 1-Cat. No. **800H-NP45**
- 1-Cat. No. **800H-NP46B**
- 6-Cat. No. **800H-NP7**

Plus up to four 1 in. plugs (Cat. No. **800H-NP11**) to close unused conduit openings.

**Caution:** Do not assemble more than eight enclosure gangs together, to avoid exceeding the internal volume for which the flame path of these enclosures is designed.



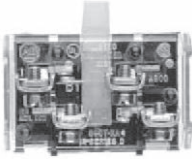
\* When coupling modular enclosures together, a coupler kit (Cat. No. **800H-NP7**) is required between enclosures.  
 † 1 in. conduit through-feed (all gangs).

**Modifications and Accessories**

**Contact Blocks**

Packaged in kit form for field installation. All necessary mounting hardware is provided with each contact block kit. Contact ratings are listed on page 10-153.

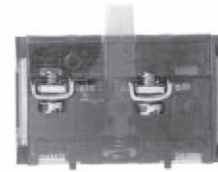
**Note:** It is not recommended to mount more than four contact blocks on any one unit (maximum two blocks deep). Sealed switch contact blocks are limited to two blocks per unit maximum.



**Shallow Block**



**Mini Block**



**PentUFF (Low Voltage) Contact Block**

Contact Type	Shallow Block*†‡	Mini Block*†	PentUFF (Low Voltage) Block*†‡
	Cat. No.	Cat. No.	Cat. No.
1 N.O.	800T-XD1	800T-XD5	800T-XD1V
1 N.C.	800T-XD2	800T-XD6	800T-XD2V
1 N.O.E.M.	800T-XD3	—	800T-XD3V
1 N.C.L.B.	800T-XD4	—	800T-XD4V
1 N.O. - N.C.	800T-XA	—	800T-XAV
2 N.O.	800T-XA2	—	—
2 N.C.	800T-XA4	—	—
1 N.C.L.B. - 1 N.O.	800T-XA1	—	—
1 N.C.L.B. - 1 N.C.	800T-XA7	—	—

\* To determine if a conduit seal-off is necessary, see page 10-179 for sealing well information.

‡ Specify Bulletin 800TC for finger-safe contact blocks. Example: **Cat. No. 800TC-XA**.

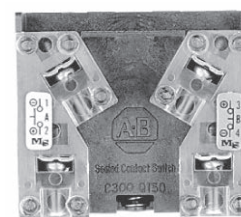
† Contact blocks with normally closed contacts meet direct drive positive opening standard requirements.



**Logic Reed Block**



**Sealed Switch Block**



**Stackable Sealed Switch Block**

Contact Type	Logic Reed Block§	Sealed Switch Block§	Stackable Sealed Switch Block§
	Cat. No.	Cat. No.	Cat. No.
1 N.O.	800T-XD1R	800T-XD1P	800T-XD1Y
1 N.C.	800T-XD2R	800T-XD2P	800T-XD2Y
1 N.O. - 1 N.C.	800T-XAR	800T-XAP	800T-XAY
2 N.O.	800T-XA2R	—	800T-XA2Y
2 N.C.	800T-XA4R	—	800T-XA4Y

§ To determine if a conduit seal-off is necessary, see page 10-179 for sealing well information.

‡ Refer to 800T/H section, page 10-35, for additional contact blocks and accessories.



# Hazardous Location Push Buttons

## Accessories

### Modifications and Accessories, Continued

#### Replacement Color Caps (Illuminated)



Pilot Light  
Cat. No. 800H-N104M



Push-to-Test Pilot Light  
Cat. No. 800H-N105M



Illuminated Push Button  
Cat. No. 800H-N106M



Illuminated Push-Pull  
Cat. No. 800H-NP50M

Color	Pilot Light	Push-to-Test Pilot Light	Illuminated Push Button	Illuminated Push-Pull
	Cat. No.	Cat. No.	Cat. No.	Cat. No.
Multi-color kit	800H-N104M	800H-N105M	800H-N106M	800H-NP50M

#### Replacement Color Caps (Non-Illuminated)



Momentary Mushroom — Standard (Plastic)  
Cat. No. 800T-N246R



Momentary Mushroom — Jumbo (Metal)  
Cat. No. 800T-N248R



Push-Pull — Standard (Metal)  
Cat. No. 800H-NP51C



Push-Pull — Jumbo (Metal)  
Cat. No. 800H-NP52A

Color	Momentary Mushroom — Standard (Plastic)	Momentary Mushroom — Jumbo (Metal) *	Push-Pull Standard (Metal)	Push-Pull Jumbo (Metal)
	Cat. No.	Cat. No.	Cat. No.	Cat. No.
Red	<b>800T-N246R</b>	<b>800T-N248R</b>	800H-NP51A	800H-NP52A
Green	<b>800T-N246G</b>	800T-N248G	800H-NP51B	800H-NP52B
Blue	800T-N246BL	800T-N248BL	800H-NP51C	800H-NP52C
Yellow	<b>800T-N246Y</b>	800T-N248Y	800H-NP51E	800H-NP52E
Black	<b>800T-N246B</b>	800T-N248B	800H-NP51H	800H-NP52H
Grey	800T-N246GR	800T-N248GR	800H-NP51G	—
Natural	—	800T-N248	—	—

\* To order plastic jumbo mushroom caps, replace **248** with **247**. Plastic not available in natural color.  
Example: Cat. No. **800T-N248R** becomes Cat. No. **800T-N247R**.

#### Replacement Knobs and Dual Push Button Assembly



Standard Knob  
Cat. No. 800H-N130F



Knob Lever  
Cat. No. 800H-131F



Wing Lever  
Cat. No. 800H-N138



Dual Push Button  
Cat. No. 800H-NP39

Color	Standard Knob	Knob Lever	Wing Lever*	Dual Push Button
	Cat. No.	Cat. No.	Cat. No.	Cat. No.
White	<b>800H-N130F</b>	800H-N131F	—	—
Kit (Complete) ‡	800H-N130	800H-N131	—	—
Grey	—	—	800H-N138	—
Red	—	—	800H-N138A	—
Green Red	—	—	—	800H-NP39

\* Standard finish is grey.

‡ Kit includes knob and packet of inserts (Cat. No. 800T-N123). Refer to color insert kits on page 10-179.



**Modifications and Accessories, Continued**

**Boots—Non-Illuminated Momentary Contact Push Buttons Units**

**Note:** For Bul. 800H/HL Type 7&9 operators, order one adapter and one boot per operator.

**Adapters**

Push Button Type	Cat. No.
Flush head	800H-NPAF
Extended head	800H-NPAE

**Boots**

Boots supplied with control stations and components are made of a chlorosulfonated polyethylene material with stainless steel insert ring. To order boots with silicone, urethane, or ethylene propylene material, see the table below. Material application information shown below.



**Cat. No. 800H-N5A**

Insert Material	Boot Color	Material			
		Chlorosulfonated Polyethylene ‡	Silicone • ‡	Urethane •• ‡	Ethylene • Propylene •• ‡
		Cat. No.	Cat. No.	Cat. No.	Cat. No.
Stainless steel §	Red	<b>800H-N5A</b>	<b>800H-N101R</b>	<b>800H-N100R</b>	800H-N103R
	Green	<b>800H-N5B</b>	<b>800H-N101G</b>	<b>800H-N100G</b>	800H-N103G
	Black	<b>800H-N5H</b>	<b>800H-N101B</b>	<b>800H-N100B</b>	800H-N103B
	Yellow	<b>800H-N5E</b>	<b>800H-N101Y</b>	800H-N100Y	—
	Blue	<b>800H-N5C</b>	800H-N101BL	800H-N100BL	—

\* May be added to flush or extended head push button units to protect against foreign materials reaching the opening between the button and the locking ring.

§ Series B boots incorporate a stainless steel insert as standard.

‡ Dots printed on the inside of the boot identify the boot material.

**Booted Knobs**



*Booted Standard Knob Selector Switch*  
**Cat. No. 800H-NP5**



*Booted Knob Lever Selector Switch*  
**Cat. No. 800H-NPE5**

Switch Type	Boot Material*			
	Chlorosulfonated Polyethylene	Silicone •	Urethane ••	Ethylene • Propylene ••
	Cat. No.	Cat. No.	Cat. No.	Cat. No.
Standard Knob Selector Switch*	800H-NP5	800H-NP101	800H-NP100	800H-NP103
Knob Lever Selector Switch*	800H-NPE5	800H-NPE101	800H-NPE100	800H-NPE103

\* Dots printed on the inside of the boot identify the boot material.

\* Includes color insert kit.

**Push Button Guards and Mushroom Push Button Guards**



**Cat. No. 800H-NP19**



**Cat. No. 800H-NP13**



**Cat. No. 800H-NP9**



**Cat. No. 800H-NP12**

Push Buttons, Pilot Lights and Push-to-Test	Extra Long Guard (1 in.) for Push Button	Mushroom	Jumbo Mushroom
Cat. No.	Cat. No.	Cat. No.	Cat. No.
800H-NP19	800H-NP13	800H-NP9	800H-NP12

**Protective Rings**



*Protective Ring for 2-Position Push-Pull*  
**Cat. No. 800H-NP40**



*Jumbo Protective Ring for 2-Position Push-Pull*  
**Cat. No. 800H-NP40J**




Protective Ring for Push-Pull Devices		
Description	Type	Cat. No.
Protective ring for Bul. 800H 2-position non-illuminated push-pull operators. Often used to avoid unintentional tripping of E-stop operators. Available for standard size button (40 mm) or for jumbo button (60 mm).	For standard size button	<b>800H-NP40</b>
	For jumbo size button	<b>800H-NP40J</b>

# Hazardous Location Push Buttons



## Accessories

### General Accessories

#### Plugs


	Description	Cat. No.	
 Cat. No. 800H-NP7	<b>Coupler</b> Used for both horizontal and vertical assembly.	<b>800H-NP7</b>	
	Description	Type	Cat. No.
 Cat. No. 800H-NP1 (Operators not included)	<b>Closing Plug</b> Whenever an enclosure with more than the required number of openings is used, this plug can be used to close the unused openings. Includes synthetic O-ring washer.	For Cover Hole	<b>800H-NP1</b>
		For Base Coupler Hole	<b>800H-NP3</b>
	Description	Size	Cat. No.
 Cat. No. 800H-NP10 (Operators not included)	<b>Conduit Entry Plug</b> This plug can be used to plug unused conduit openings in Type 7 and 9 bases.	3/4 in.	800H-NP10
		1 in.	<b>800H-NP11</b>

#### Locking Attachments






	Description	Cat. No.
 Cat. No. 800H-NP2 (Padlock not included)	<b>Push Button Padlocking Attachments</b> This device permits locking in the depressed position on extended head push button units only.	800H-NP2
 Cat. No. 800H-NP17 (Padlock not included)	<b>Dual Push Button Extended Head Padlocking Attachments</b> This device permits locking for dual push button — extended head units only.	800H-NP17

### General Accessories, Continued

#### Locking Attachments

	Description	Cat. No.
 <p><b>Cat. No. 800H-NP4</b> (Padlock not included)</p>	<p><b>Padlocking Cover</b> Padlocking cover is used for Type 7 and 9 selector switches, non-illuminated push buttons (except mushrooms) and non-illuminated 2-position push-pull units, but not for potentiometer units. <b>Note:</b> Push-pull units will only lock in the depressed position. Padlocking cover includes blank legend plate for customer marking. A pre-marked legend plate entitled OPEN COVER TO OPERATE (front view) and PULL-TO-START-PUSH-TO-STOP (rear view) is available. To order legend plate only, specify Cat. No. 800H-W174L.</p>	<b>800H-NP4</b>

#### Miscellaneous




	Description	Style	No. of Wires	Cat. No.		
 <p><b>Cat. No. 800H-NPRD91</b></p>	 <p><b>Cat. No. 800H-NPD93</b></p>	With Integral Flange Seal, Type 3, 7, and 9	2	800H-NPRD90		
			4	800H-NPRD91		
			6	800H-NPRD92		
			8	800H-NPRD93		
				Without Integral Flange Seal, Type 7 and 9	2	800H-NPD90
					4	800H-NPD91
					6	800H-NPD92
					8	800H-NPD93
	Description	Style	Cat. No.			
 <p><b>Cat. No. 800H-NP20</b></p>	<p><b>Type 3 Flange Seal</b> This seal provides a Type 3 rating while maintaining Type 7 and 9 integrity. An approved drain (see listing) is required for condensation when using this option (refer to National Electrical Code). For a Type 4 rating, use sealing nuts to seal the push button operators in addition to using the flange seal. Sealing kit is comprised of flange seal and sealing nut. They are used with the Allen-Bradley enclosures listed on page 10-154 for outdoor applications.</p>	Flange Seal	<b>800H-NP20</b>			
		Drain for 3/4 in. Conduit Opening	<b>800H-NP21</b>			
		Drain for 1 in. Conduit Opening	800H-NP22			
 <p><b>Cat. No. 800H-NP21</b></p>		Type 4 Sealing Nut	<b>800H-N479</b>			
		Type 4 Sealing Kit	<b>800H-N479F</b>			
	Description	Color	Cat. No.			
 <p><b>Cat. No. 800H-NP23R</b></p>	<p><b>Color Insert Kit</b> These color insert kits are used with illuminated push buttons, pilot lights, push-pull, and push-to-test push buttons (order quantity of 1 to receive kit of 5 inserts).</p>	Red	800H-NP23R			
		Green	800H-NP23G			
		Amber	800H-NP23A			
		Blue	800H-NP23B			
		White	800H-NP23W			
		One of each color	800H-NP23			

# Hazardous Location Push Buttons

## Accessories

### Replacement Lamps

Pilot Lights, Illuminated Push Buttons, Illuminated Push-Pull, Illuminated Push-Pull/Twist to Release, and Illuminated Selector Switches

Lamp	Type	Current, Typical	Lamp Voltage	ANSI No.	Catalog Voltage Code	Cat. No.
	Full Voltage Transformer	150 mA/250 mA	6.3V AC	755/1866	6, 16, 26, 36, 46, 56, 76	* <b>800T-N65</b>
	Full Voltage	80 mA	14V AC/DC	756	12	* 800T-N141
		70 mA	24V AC/DC	757	24	* <b>800T-N157</b>
		50 mA	48V AC/DC	1835	48	* 800T-N365
	Full Voltage Resistor	22 mA	120V AC/DC	949	10, 11	* <b>800T-N169</b>
	Flashing	150 mA	6V AC/DC	267	6	* <b>800T-N212</b>
		57 mA	24V AC/DC	24 MB	24	* 800T-N180
Dual Input Diode	21 mA	120V AC	90 MB	16	* 800T-N261	
Neon 	—	2 mA	120V AC/DC	B2A	10, 20	<b>609-N9</b>
Lamp	Type	Current, Typical*	Lamp Voltage	Leakage Current	Code	Cat. No.*
	Universal	13 mA @ 24V DC 8.5 mA @ 120V AC†	3V‡	3 mA	2	800T-N376x
	Transformer	60	6V	14 mA	16, 26, 46, 56	800T-N377x


\* Item is sold in multiples of 5. Order quantity of 5 to receive package of 5 pieces.

\* To complete the cat. no. replace the **x** with the first letter of the desired color: **Green**, **Red**, or **White**.

† Typical current consumption values indicated are relative to the input of the power module.

‡ Lamp is intended for use with power module Cat. No. 800TC-N374 which has an input voltage rating of 12 ...130V AC/DC.

### Legacy LED Lamps\*

Lamp	Type	Current, Typical>	Lamp Voltage	Leakage Current	Catalog Voltage Code	Cat. No.‡
	Full Voltage	13 mA/22 mA	12V AC/DC	3 mA	12	800T-N362x
		20 mA/21 mA	24V AC/DC	3 mA	24	800T-N319x
		12 mA/17 mA	32V AC/DC	3 mA	32	800T-N363x
		9 mA/14 mA	48V AC/DC	3 mA	48	800T-N364x
		3.3 mA/6 mA	120V AC	—	10	800T-N320x
		4.5 mA/6.2 mA	130V AC/DC	3 mA	13	800T-N321x
	Full voltage	50 mA	6V AC	14 mA	6, 16, 26, 36, 46, 56, 76	800T-N318x
Flashing	18 mA	24V AC/DC	—	N/A	† 800T-N319Fx	

\* In full voltage applications, these lamps are intended to be used with power module Cat. No. 800T-N330.

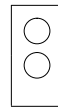
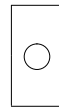
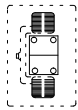
‡ All LEDs except 120V have an internal shunt resistor for use with solid-state outputs. LEDs will not illuminate below listed leakage current.

> Typical current draw varies with LED color. The first mA value is for a green or blue LED and the second mA value is for a red or amber LED.

‡ To complete the cat. no. replace the **x** with the first letter of the desired color: **Amber**, **Green**, **Red**, **Blue**, or **White**. White LEDs only available in 6V, 24V, 120V, and 130V.

† Flashing rate is 2 Hz.

**Legend Plates**



**Blank Legend Plates**

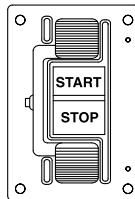
	Lever Style	Standard Size	Jumbo Size	Special Jumbo Size
	Use 1 lever style legend with each lever type cover (Cat. Nos. 800H-NP14, -NP15, -NP16 or -NP34)	Use 2 standard size legends with each standard 2 hole cover (Cat. No. 800H-NP31)	Use 1 jumbo size legend with each standard 1 hole cover (Cat. No. 800H-NP30)	Use 1 special jumbo legend with each special 2 hole cover (Cat. No. 800H-NP33) Ex: Dual Push Button/ Pigtail Pilot Light
Legend Plate Color	Cat. No.	Cat. No.	Cat. No.	Cat. No.
Grey	—	<b>800H-Y59</b>	<b>800H-Y59J</b>	800H-Y141J
Red	—	<b>800H-Y121</b>	<b>800H-Y121J</b>	—
Green	—	<b>800H-Y136</b>	800H-Y136J	—
Yellow	—	800H-Y700	800H-Y700J	—
Top Grey — Bottom Grey	800H-Y222	—	—	—
Top Grey — Bottom Red	800H-Y223	—	—	—
Left Green — Right Red	—	—	—	800H-Y140J
Grey with Potentiometer Graduations	—	<b>800H-Y109</b>	800H-Y109J	—

**Custom Legend Plates**

	Lever Style	Standard Size	Jumbo Size	Special Jumbo Size
	Use 1 lever style legend with each lever type cover (Cat. Nos. 800H-NP14, -NP15, -NP16 or -NP34)	Use 2 standard size legends with each standard 2 hole cover (Cat. No. 800H-NP31)	Use 1 jumbo size legend with each standard 1 hole cover (Cat. No. 800H-NP30)	Use 1 special jumbo legend with each special 2 hole cover (Cat. No. 800H-NP33) Ex: Dual Push Button/ Pigtail Pilot Light
Legend Plate Color	Cat. No.	Cat. No.	Cat. No.	Cat. No.
Grey	—	* 800H-Y59E	* 800H-Y59JE	* 800H-Y141JE
Red	—	* 800H-Y121E	* 800H-Y121JE	—
Green	—	* 800H-Y136E	* 800H-Y136JE	—
Yellow	—	800H-Y700E	800H-Y700JE	—
Top Grey — Bottom Grey	* 800H-Y222E	—	—	—
Top Grey — Bottom Red	* 800H-Y223E	—	—	—
Left Green — Right Red	—	—	—	* 800H-Y140JE
Grey with Potentiometer Graduations	—	* 800H-Y109E	* 800H-Y109JE	—

\* Horizontally mounted engraved legend plates (with standard or custom marking) are available. Add the letter **H** after the **Y** in the cat. no.  
 Example: Cat. No. **800H-Y222E** becomes **800H-YH222E**.

**Lever Style Legend Plates with Standard Markings**



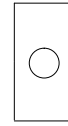
Legend Marking	Cat. No.	Legend Marking	Cat. No.
Upper/Lower		Upper/Lower	
HAND AUTO	800H-Y228	OPEN CLOSE	800H-Y205
JOG RUN	800H-Y227	RUN STOP (Red)	800H-Y226
JOG STOP (Red)	800H-Y206	START STOP (Red)	800H-Y200
ON OFF	800H-Y225	—	—

# Hazardous Location Push Buttons

## Accessories

### Legend Plates, Continued

#### Legend Plates with Standard Markings



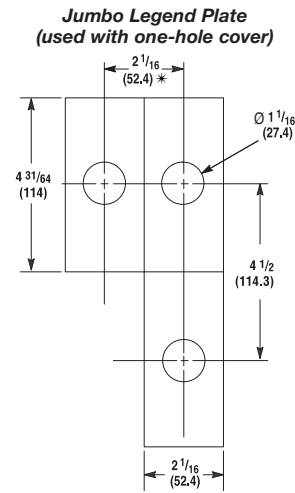
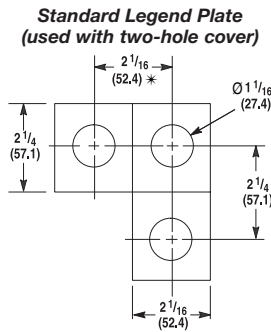
Legend Marking	Standard Size	Jumbo Size	Legend Marking	Standard Size	Jumbo Size
	Cat. No.	Cat. No.		Cat. No.	Cat. No.
AUTO-OFF-HAND	<b>800H-Y1</b>	800H-Y1J	ON	<b>800H-Y30</b>	800H-Y30J
AUTO-MAN-HAND	800H-Y125	800H-Y125J	OPEN	<b>800H-Y31</b>	800H-Y31J
CLOSE	<b>800H-Y2</b>	800H-Y2J	OPEN-CLOSE	800H-Y32	800H-Y32J
CYCLE START	800H-Y62	800H-Y62J	OPEN-OFF-CLOSE	800H-Y33	800H-Y33J
DOWN	<b>800H-Y3</b>	800H-Y3J	OUT	800H-Y34	—
EMERG. STOP (Red)	<b>800H-Y4</b>	<b>800H-Y4J</b>	PUSH TO STOP-PULL TO START	800H-Y118	800H-Y118J
FAST	800H-Y5	800H-Y5J	POWER ON	800H-Y139	800H-Y139J
FEED START	800H-Y66	800H-Y66J	RAISE	800H-Y35	800H-Y35J
FEED STOP	800H-Y67	800H-Y67J	RAISE-LOWER	800H-Y36	800H-Y36J
FOR.-REV.	800H-Y6	800H-Y6J	RAISE-OFF-LOWER	800H-Y37	800H-Y37J
FOR.-OFF-REV.	800H-Y7	800H-Y7J	RESET	<b>800H-Y38</b>	800H-Y38J
FORWARD	800H-Y8	800H-Y8J	REVERSE	<b>800H-Y39</b>	800H-Y39J
FOURTH SPEED	800H-Y124	800H-Y124J	RUN	<b>800H-Y40</b>	800H-Y40J
FULL SPEED	800H-Y9	800H-Y9J	RUN-INCH	800H-Y134	800H-Y134J
HAND-AUTO	<b>800H-Y10</b>	800H-Y10J	RUN-JOG	800H-Y41	800H-Y41J
HAND-OFF-AUTO	<b>800H-Y11</b>	800H-Y11J	SAFE-RUN	800H-Y42	800H-Y42J
HIGH	800H-Y12	800H-Y12J	SECOND SPEED	800H-Y43	800H-Y43J
HIGH-LOW	800H-Y13	800H-Y13J	SLOW	800H-Y44	800H-Y44J
HIGH-OFF-LOW	800H-Y14	800H-Y14J	SLOW-FAST	800H-Y45	800H-Y45J
IN	800H-Y15	800H-Y15J	SLOW-OFF-FAST	800H-Y46	800H-Y46J
INCH	800H-Y16	800H-Y16J	SPEED*	<b>800H-Y108</b>	800H-Y108J
JOG	<b>800H-Y17</b>	800H-Y17J	START (Green)	<b>800H-Y47</b>	800H-Y47J
JOG FORWARD	800H-Y18	800H-Y18J	START-JOG	800H-Y48	800H-Y48J
JOG REVERSE	800H-Y19	800H-Y19J	START-STOP	800H-Y49	800H-Y49J
JOG-RUN	800H-Y20	800H-Y20J	STOP (Red)	<b>800H-Y50</b>	<b>800H-Y50J</b>
JOG-SAFE-RUN	800H-Y22	800H-Y22J	STOP-START	800H-Y51	800H-Y51J
JOG-STOP-RUN	800H-Y21	800H-Y21J	SUMMER-OFF-WINTER	800H-Y53	800H-Y53J
LEFT-RIGHT	800H-Y23	800H-Y23J	SUMMER-WINTER	800H-Y52	800H-Y52J
LOW	800H-Y24	800H-Y24J	TEST	800H-Y54	800H-Y54J
LOW SPEED	800H-Y25	—	THIRD SPEED	800H-Y55	—
LOWER	800H-Y26	800H-Y26J	UP	<b>800H-Y56</b>	800H-Y56J
OFF	800H-Y27	800H-Y27J	UP-DOWN	800H-Y57	800H-Y57J
OFF-COOLANT-ON	800H-Y28	800H-Y28J	UP-OFF-DOWN	800H-Y58	800H-Y58J
OFF-ON	<b>800H-Y29</b>	800H-Y29J	—	—	—

\* Graduated potentiometer type.



## Approximate Dimensions and Shipping Weights

Dimensions in inches (millimeters). Dimensions are not intended to be used for manufacturing purposes.



**Note:** Mounting hole requirements for components — 3/4 in. - 14 NPSM.\*

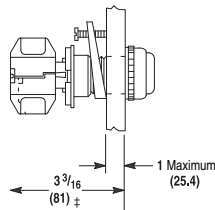
\* External thread major diameter: 1.034 in. max., 1.024 in. min.

Internal thread minor diameter: 0.958 in. min., 0.970 in. max.

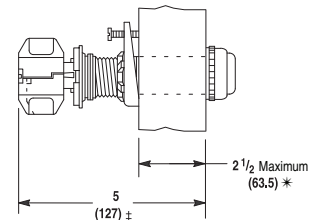
† Sketch illustrates the minimum distance between center lines when mounting Bulletin 800H units with legend plates either side by side or one above the other in non Allen-Bradley enclosures. **Minimum spacing without legend plate:** When units are mounted so that the contact block terminals face each other, the 2-1/4 in. (57.2 mm) dimension must be used in order to get proper electrical clearance. When control units are mounted so that the contact block terminals do not face each other, the 1-27/32 in. (46.8 mm) dimension can be used.

## Panel Thickness Requirements

**Standard Barrel**  
[devices will fit panels up to 1 in. (25.4 mm)]



**Long Barrel**  
[devices will fit panels up to 2-1/2 in. (63.5 mm)]

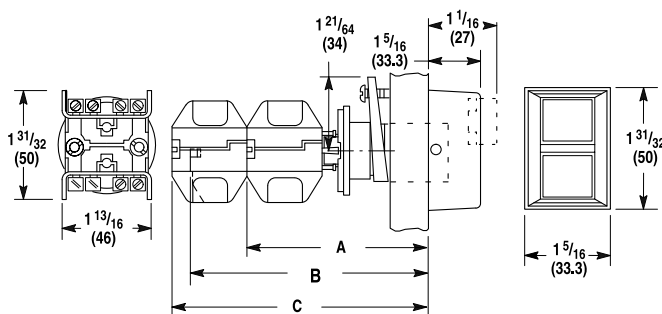


‡ When mounting in a panel thicker than 2-1/8 in. (54 mm) locking bracket not required.

† This dimension for push buttons only.

## Push Buttons

### Dual Head



Dim.	A	B	C	Ship. Wt. [oz (kg)]
Standard Barrel	3-5/16 (84.1)	4-3/16 (106.4)	4-7/16 (112.7)	10-3/8 (0.30)
Long Barrel	4-19/32 (116.7)	5-15/32 (138.9)	5-23/32 (145.2)	13 (0.37)



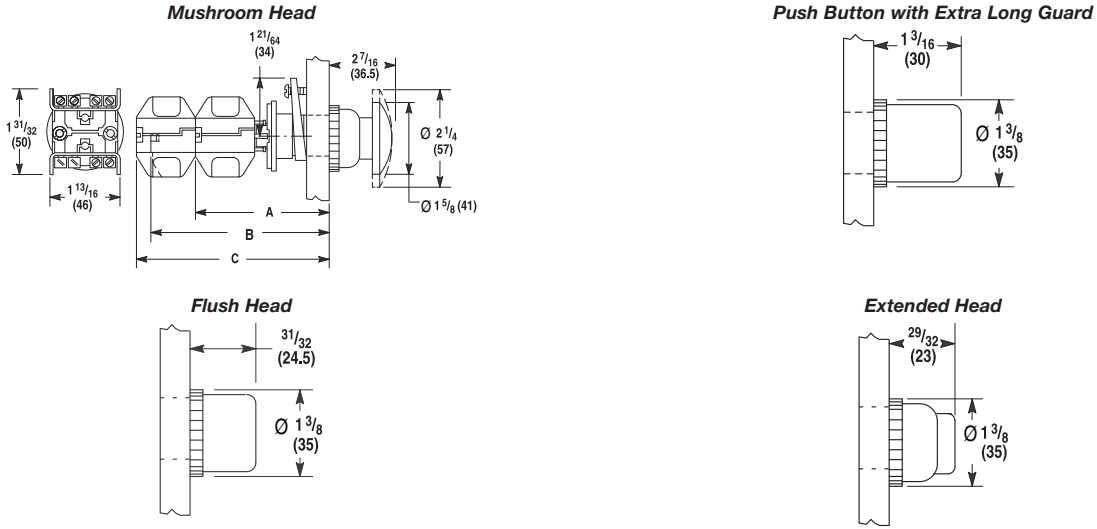
# Hazardous Location Push Buttons

## Approximate Dimensions

### Approximate Dimensions and Shipping Weights, Continued

Dimensions in inches (millimeters). Dimensions are not intended to be used for manufacturing purposes.

#### Push Buttons

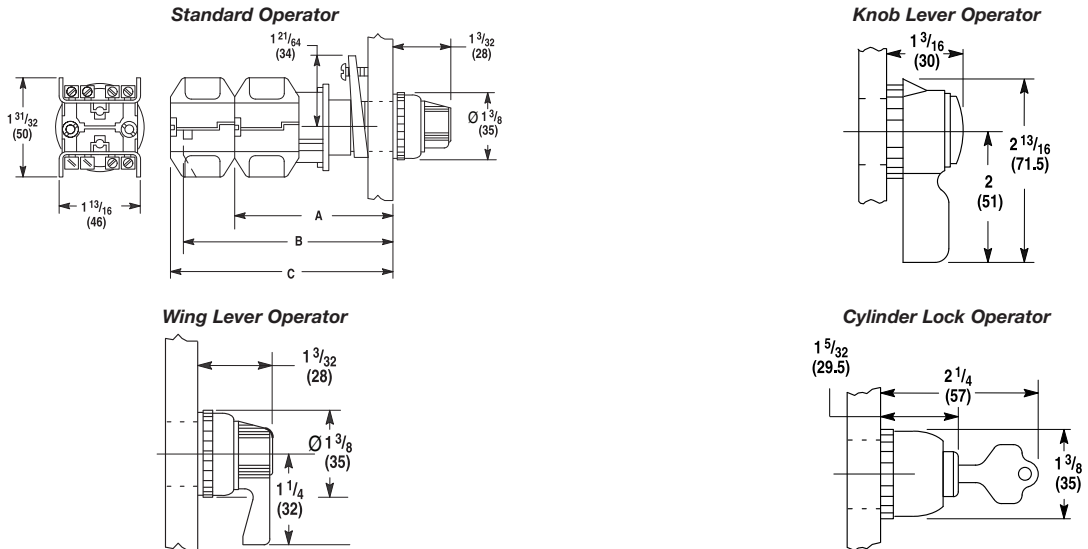


Type	Standard Barrel				Long Barrel			
	A *	B	C	Ship. Wt. [oz (kg)]	A *	B	C	Ship. Wt. [oz (kg)]
Mushroom, Flush and Extended Head	3-3/16 (81)	4-1/8 (105)	4-3/8 (111)	9-7/8 (0.28)	5 (127)	5-7/8 (149.2)	6-1/8 (155.6)	13-5/16 (0.38)
Extra Long Guard	3-3/16 (81)	4-1/8 (105)	4-3/8 (111)	10-7/8 (0.31)	5 (127)	5-7/8 (149.2)	6-1/8 (155.6)	14-5/16 (0.40)

\* When using sealed switch contact block, this dimension is 4-1/16 in. (103 mm).

\* When using sealed switch contact block, this dimension is 5-7/8 in. (149.2 mm).

#### Selector Switches



Type	Standard Barrel				Long Barrel			
	A *	B	C	Ship. Wt. [oz (kg)]	A *	B	C	Ship. Wt. [oz (kg)]
Standard and Knob Lever	3-3/16 (81)	4-1/8 (105)	4-3/8 (111)	9-1/2 (0.27)	5 (127)	5-7/8 (149.2)	6-1/8 (155.6)	14-3/8 (0.41)
Wing Lever	3-3/16 (81)	4-1/8 (105)	4-3/8 (111)	10-1/2 (0.30)	5 (127)	5-7/8 (149.2)	6-1/8 (155.6)	15 (0.42)
Cylinder Lock	3-3/16 (81)	4-1/8 (105)	4-3/8 (111)	11-1/4 (0.32)	5 (127)	5-7/8 (149.2)	6-1/8 (155.6)	16 (0.45)

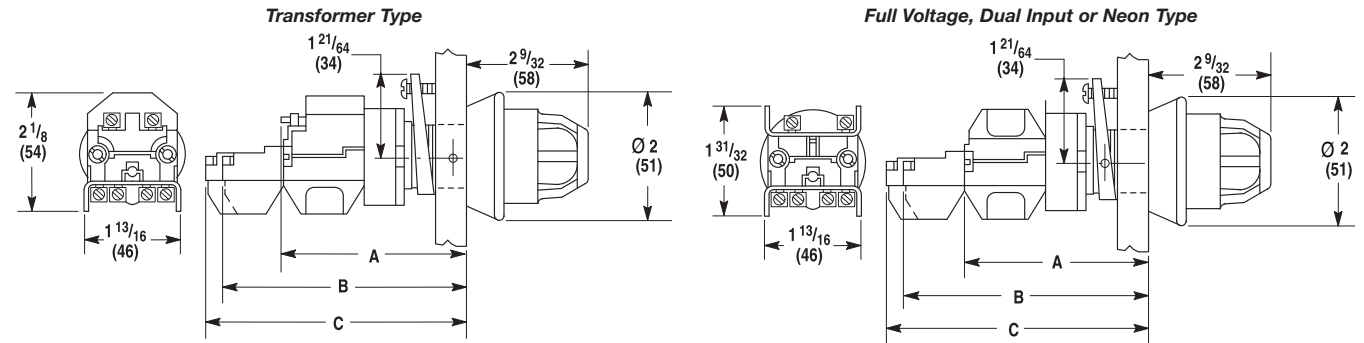
\* When using sealed switch contact block, this dimension is 4-1/16 in. (103 mm).

\* When using sealed switch contact block, this dimension is 5-7/8 in. (149.2 mm).

**Approximate Dimensions and Shipping Weights, Continued**

Dimensions in inches (millimeters). Dimensions are not intended to be used for manufacturing purposes.

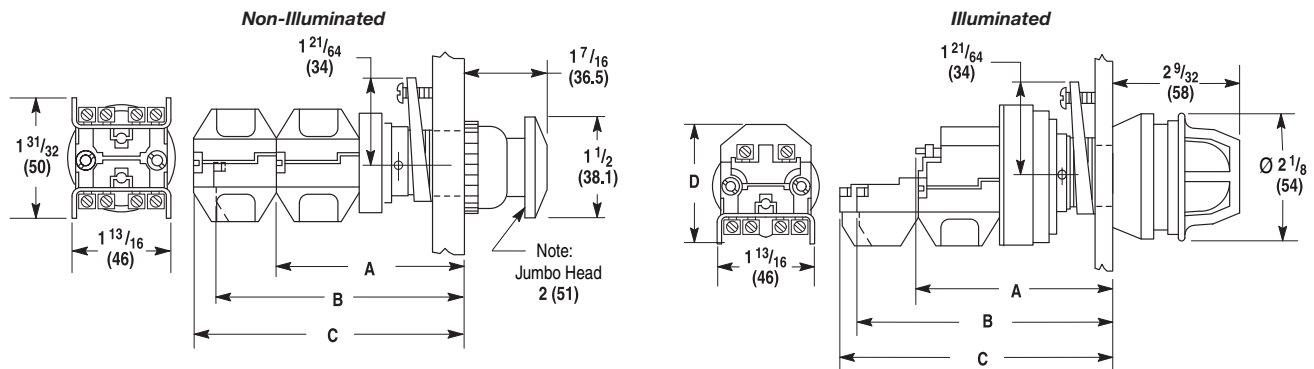
**Illuminated Push Buttons or Push-to-Test Pilot Lights**



**Illuminated Push Buttons, Push-to-Test Pilot Lights**

Description	Style	A *	B	C	Ship. Wt. [oz (kg)]
Transformer Type	Standard Barrel	3-5/32 (80.2)	3-29/32 (99)	4-1/8 (105)	14 (0.40)
	Long Barrel	5-1/16 (128.6)	5-13/16 (147.6)	6-1/16 (154)	16-3/16 (0.45)
Full Voltage Dual Input or Neon Type	Standard Barrel	3-1/32 (77)	3-29/32 (99)	4-1/8 (105)	11-5/8 (0.33)
	Long Barrel	4-15/16 (125.4)	5-13/16 (147.6)	6-1/16 (154)	13-7/16 (0.38)

**Push-Pull Units**



**Push-Pull Units**

Description	Style	A *	B	C	D	Ship. Wt. [oz (kg)]
Illuminated Transformer Type	Standard Barrel	3-9/16 (90.5)	4-9/16 (115.9)	4-5/8 (117.5)	2-1/8 (54)	15-1/2 (0.44)
	Long Barrel	4-21/32 (118.3)	5-13/32 (137)	5-21/32 (143.7)	2-1/8 (54)	17-7/16 (0.49)
Illuminated Full Voltage Type	Standard Barrel	3-7/16 (87.3)	4-9/16 (115.9)	4-5/8 (117.5)	1-31/32 (50)	12-13/16 (0.33)
	Long Barrel	4-17/32 (115.1)	5-13/32 (137)	5-21/32 (143.7)	1-31/32 (50)	14-3/4 (0.41)
Non-Illuminated Push-Pull Units	Standard Barrel	3-1/2 (88.9)	4-3/8 (111.1)	4-5/8 (117.5)	—	11-1/8 (0.32)
	Long Barrel	4-17/32 (115.1)	5-13/32 (137)	5-21/32 (143.7)	—	12-5/16 (0.34)

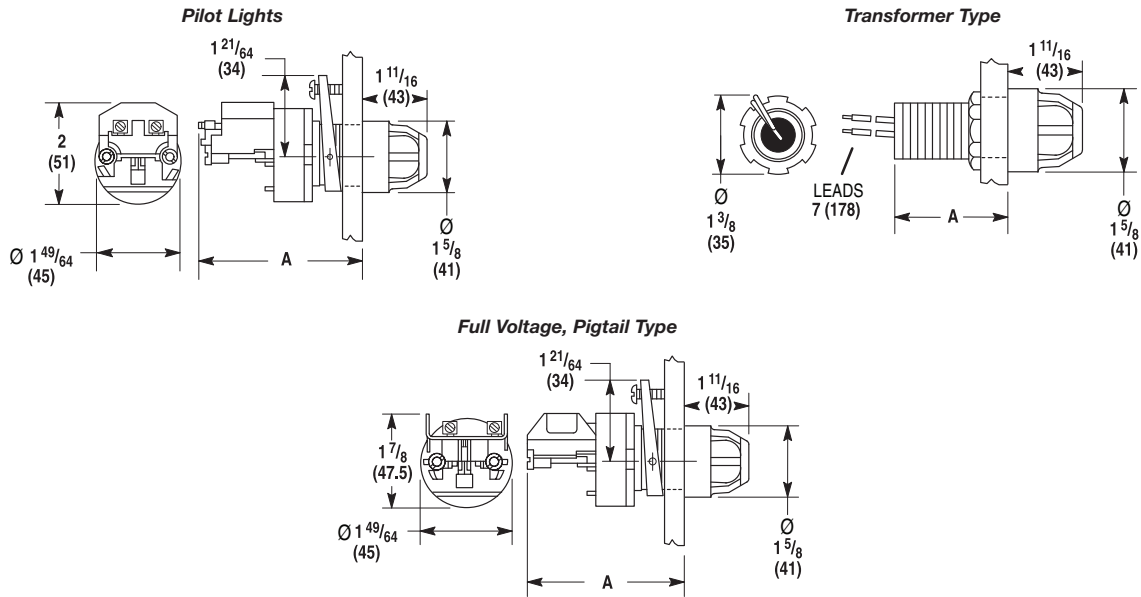
\* When using sealed switch contact block add 7/8 in. (22.2 mm) to the listed dimension.

# Hazardous Location Push Buttons

## Approximate Dimensions

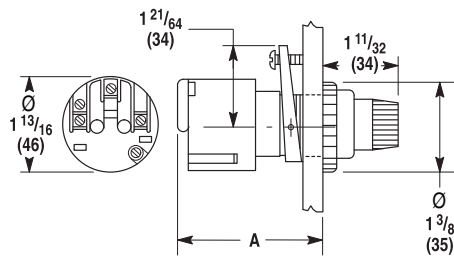
### Approximate Dimensions and Shipping Weights, Continued

Dimensions in inches (millimeters). Dimensions are not intended to be used for manufacturing purposes.



Description	Style	A	Ship. Wt. [oz (kg)]
Transformer type and dual input transformer type pilot lights	Standard Barrel	3-5/32 (80)	8-9/16 (0.24)
	Long Barrel	4-9/16 (115.9)	30-1/4 (0.85)
Full voltage, neon or dual input diode and resistor type pilot lights	Standard Barrel	3-1/32 (77)	5-13/16 (0.17)
	Long Barrel	4-7/16 (112.7)	27-1/2 (0.77)
Full voltage pigtail type pilot lights	Standard Barrel	2-3/16 (55.5)	5-5/8 (0.16)
	Long Barrel	3-43/64 (94)	8-5/16 (0.24)

### Potentiometer Units



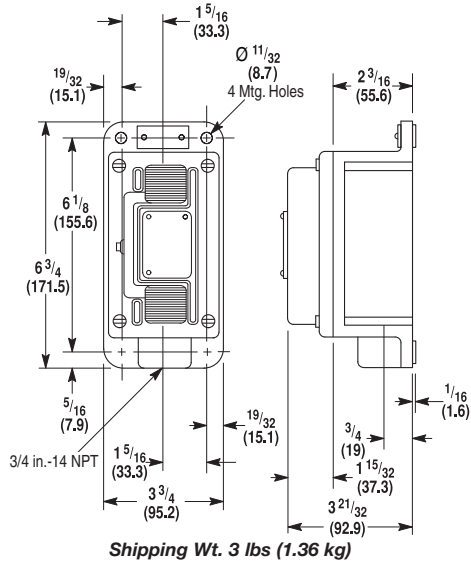
Style	A	Ship. Wt. [oz (kg)]
Standard barrel	3-1/8 (79.5)	5-3/8 (0.16)
Long barrel	4-1/2 (114.3)	8 (0.23)

**Approximate Dimensions and Shipping Weights, Continued**

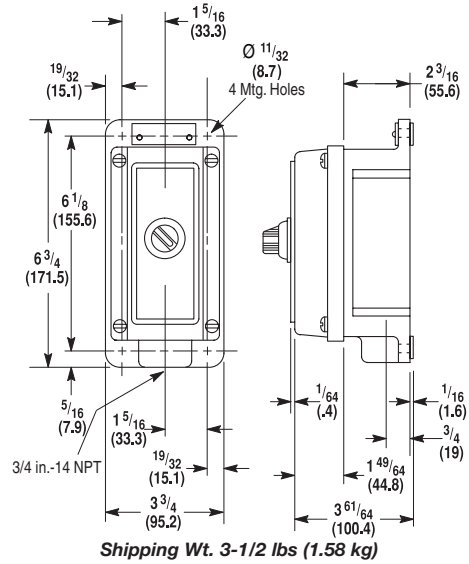
Dimensions in inches (millimeters). Dimensions are not intended to be used for manufacturing purposes.

**Shallow Base Stations**

**Figure 1**  
**Shallow Base Station Lever Type**

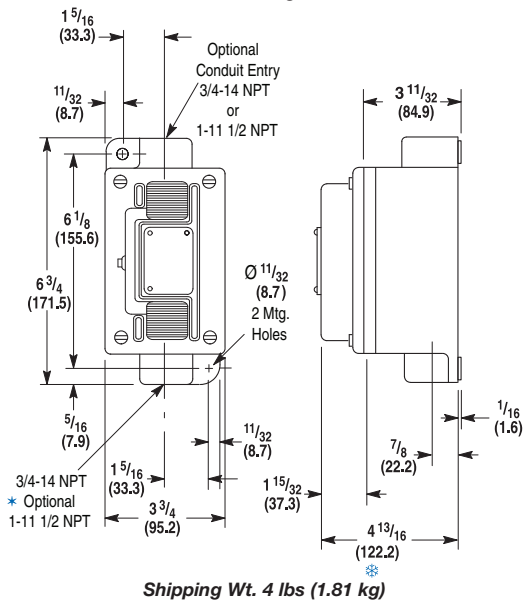


**Figure 2**  
**Shallow Base Station Component Type**  
**1-Gang (1 or 2 devices)**

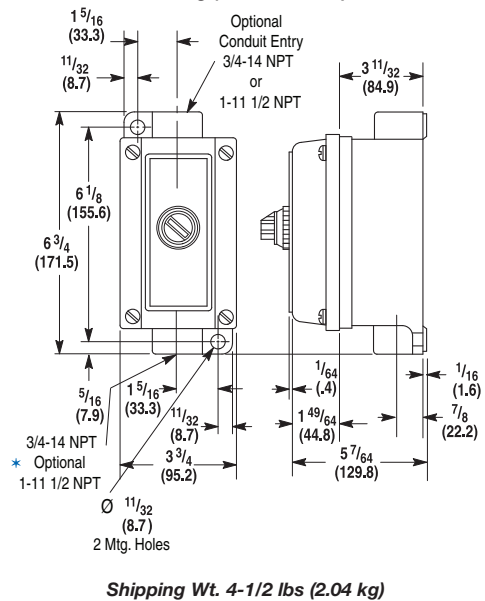


**Deep Base Stations**

**Figure 3**  
**Deep Base Station Lever Type**  
**1-Gang**



**Figure 4**  
**Deep Base Component Lever Type**  
**1-Gang (1 or 2 devices)**



\* When using a flange seal, an approved drain fitting must be provided (refer to National Electrical Code).

\* When used add the following to the max. depth: Flange seal add 3/16 in. (4.8 mm). Sealing well with or without integral flange seal add 1/2 in. (12.7 mm).

# Hazardous Location Push Buttons

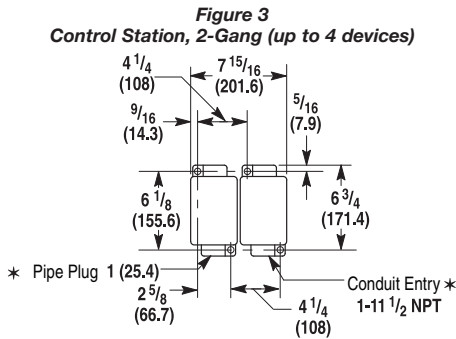
## Approximate Dimensions

### Approximate Dimensions and Shipping Weights, Continued

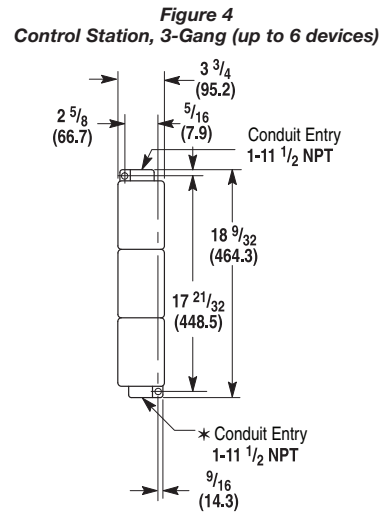
Dimensions in inches (millimeters). Dimensions are not intended to be used for manufacturing purposes.

#### Factory-Assembled Stations

For depth dimension refer to Figure 3 or 4 on page 10-187.

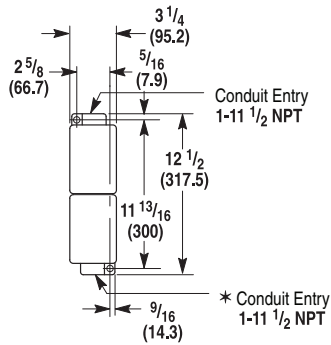


Shipping Wt. 10 lbs (4.54 kg)



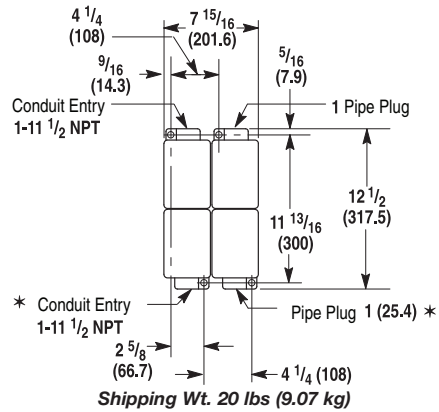
Shipping Wt. 16 lbs (7.26 kg)

**Figure 5**  
**Control Station, 2-Gang (up to 4 devices)**



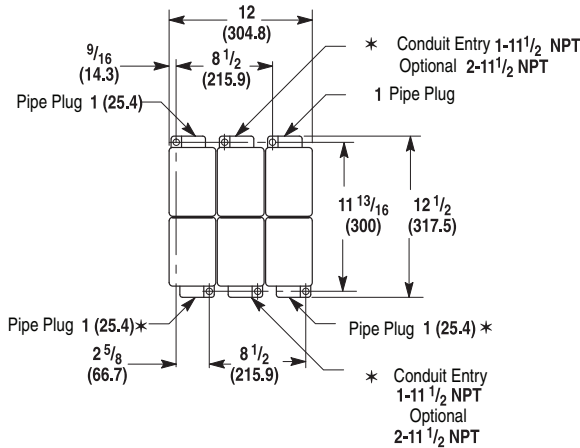
Shipping Wt. 10 lbs (4.54 kg)

**Figure 6**  
**Control Station, 4-Gang (up to 8 devices)**



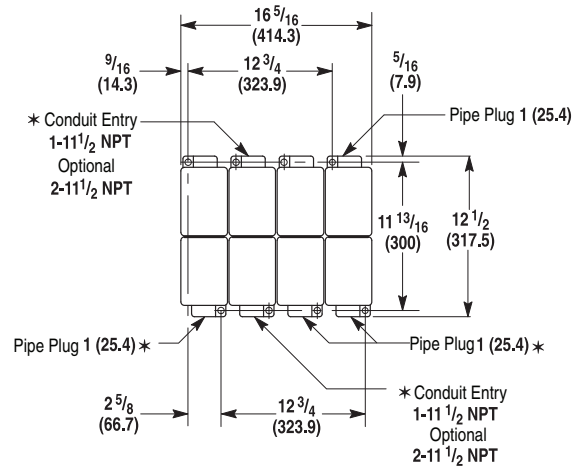
Shipping Wt. 20 lbs (9.07 kg)

**Figure 7**  
**Control Station, 6-Gang (up to 12 devices)**



Shipping Wt. 32 lbs (14.5 kg)


**Figure 8**  
**Control Station, 8-Gang (up to 16 devices)**



Shipping Wt. 40 lbs (18.1 kg)

# 30.5 mm Push Button Stations Hermetically Sealed for Division 2/Zone 2

## Product Overview

	<p><b>Bulletin 800R — 30.5 mm Push Button Stations Hermetically Sealed for Division 2/Zone 2</b></p> <ul style="list-style-type: none"> <li>• Hazardous location push button stations</li> <li>• Classes I and II Division 2/Zone 2</li> <li>• 30.5 mm mounting hole</li> <li>• Types 4/13 and 4/4X/13</li> </ul>	<p><b>Table of Contents</b></p> <p>Specifications..... this page Complete</p> <p>Assembled Stations.. 10-191</p> <p>Custom-Built Stations..... 10-192</p> <p>Enclosures Only ..... 10-192</p> <p>Approximate Dimensions..... 10-193</p>
---	---	---

### Specifications\*

Electrical Ratings		
Contact Ratings	Refer to the contact ratings (page 10-190).	
Dielectric Strength	2200V for one minute, 1300V for one minute (Logic Reed)	
Electrical Design Life Cycles	1 000 000 at maximum rated load, 200 000 at maximum rated load (Logic Reed)	
Mechanical Ratings		
Vibration	10...2000 Hz 1.52 mm displacement (peak-to-peak) Max./10 G Max. (except Logic Reed)	
Shock	1/2 cycle sine wave for 11 ms ≥25 G (contact fragility) and no damage at 100 G	
Degree of Protection	Type 4/4X/13, 4/13; Watertight/Corrosion-Resistant IEC 529 IP66/65	
Mechanical Design Life Cycles		
Push Buttons	(Momentary, Non-Illuminated) (Momentary, Illuminated) (Push-Pull/Twist-to-Release)	1 000 000 min. 250 000 min. 250 000 min.
Selector Switches	(Non-Illuminated) (Illuminated)	1 000 000 min. 200 000 min.
All other devices		200 000 min.
Contact Operation	Logic Reed and sealed switch contact blocks: single break magnetic	
Typical Operating Forces		
Operators without contact blocks	Flush, extended, standard mushroom, jumbo plastic mushroom: 2 lb max. Maintained selector switch: 3.6 in•lb maximum	
Spring Return Selector Switches	3.6 in•lb to stop 0.2 in•lb to return	
Illuminated Push Buttons and Push-to-Test Pilot Lights	5 lb maximum	
3-Position Push-Pull	8 lb maximum push to in position or pull to center position (15 lb maximum pull to out position)	
Push-Pull and Push-Pull/Twist	9 lb maximum push or pull 30 in•oz maximum twist, 6 in•oz minimum return	
Contact Blocks	Logic Reed Sealed Switch Stackable Sealed Switch	1 lb maximum 3 lb maximum at 0.205 in. plunger travel 1 lb maximum
Environment		
Temperature Range	Operating Storage	-40...+131 °F (-40...+55 °C) -40...+185 °F (-40...+85 °C)
<b>Note:</b> Operating temperatures below freezing are based on the absence of moisture and liquids. Consult your local Rockwell Automation sales office or Allen-Bradley distributor for use in lower temperature applications.		
Humidity		50% at 104 °F (40 °C)

\* Performance Data — See page Important-3.



## 30.5 mm Push Button Stations Hermetically Sealed for Division 2/Zone 2

### Product Overview

#### Control Stations

Bulletin 800R control stations are designed for Division 2/Zone 2 hazardous locations. They consist of Bulletin 800H (Type 4/4X/13) or Bulletin 800T (Type 4/13) operators with sealed contact blocks. Bulletin 800R units are available as factory assembled stations or as components for field assembly.

#### Hazardous Locations

Since the contacts are enclosed in a hermetically sealed chamber, the contact block is suitable for use in Class I and II, Division 2/Zone 2 Groups A, B, C, D, F and G hazardous locations and is listed by Underwriters Laboratories for this class of service.

Complete stations as shown on page 2-23 can be used for Class I and II Division 2/Zone 2 applications. The individual components shown in the 800T and 800H sections are also suitable for Class I and II Division 2/Zone 2 locations providing they are suitably mounted by the customer in an enclosure as required for the application and by applicable codes and laws.

Per National Electrical Code: Zone 2. In Class I, Zone 2 locations, all wiring methods permitted for Class I, Division 2, Class I, Division 1 or Division 2, and Class I, Zone 0 or Zone 1 locations, including requirements for sealing, shall be permitted.

**Note:** Allen-Bradley Logic Reed contact blocks are also listed by Underwriters Laboratories for the Division 2/Zone 2 hazardous locations listed above.



#### CAUTION:

The complete stations and individual components listed herein **are not suitable for use in Class I and II Division 1 hazardous locations**. For Class I and II Division 1 hazardous locations, order Bulletin 800H Type 7 & 9 stations and units.

#### Sealed Switch Contact Ratings

Maximum continuous current  $I_{th}$  5 A. Bulletin 800T and 800H units have control circuit ratings with sealed switch contact blocks as follows:

Max. Opertrnl. Volts $U_e$	Utilization Category		Rated Operational Currents		
	IEC	NEMA	Volts $U_e$	Make	Break
AC 600	AC-15	B600	120...600 0...120	3600 VA 30 A	360 VA 3 A
DC 300	DC-13	P300	24...300 0...24	138 VA 5.0 A	

#### Stackable Sealed Switch Contact Ratings

Maximum continuous current  $I_{th}$  2.5 A. Bulletin 800T and 800H units have control circuit ratings with sealed switch contact blocks as follows:

Max. Opertrnl. Volts $U_e$	Utilization Category		Rated Operational Currents		
	IEC	NEMA	Volts $U_e$	Make	Break
AC 300	AC-15	C300	120...300 0...120	1800 VA 15 A	180 VA 1.5 A
DC 150	DC-13	Q150	24...150 0...24	69 VA 2.5 A	

#### Logic Reed Contact Ratings

Maximum DC: 30V, 0.06 A Maximum AC: 150V, 0.15 A  
Should only be used with resistive loads.

#### Standards Compliance

- UL 1604
- CSA C22.2, No. 213

#### Certifications

- UL Listed (File No. E10314, Guide No. NOIV)
- CSA Certified (File No. LR11924)

## 30.5 mm Push Button Stations Hermetically Sealed for Division 2/Zone 2

Product Selection

## Complete Assembled Stations

## Class I, Division 2/Zone 2

Push button operators for Class I, Division 2/Zone 2 are offered in Bulletin 800T/H, page 10-2.



Surface Mount  
Cat. No. 800R-1TA



Stainless Steel  
Booted Operator Station  
Cat. No. 800R-1HA4T



Stainless Steel  
Bootless Operator Station  
Cat. No. 800R-1HA4TL



Rosite  
Booted Operator Station  
Cat. No. 800R-1HA4R



Rosite  
Bootless Operator Station  
Cat. No. 800R-1HA4RL

Operator	Contact Symbol	Contact Action	Button Type	Button Color	Legend Marking	Cast Aluminum Enclosures*	Stainless Steel Enclosures*	Rosite Glass Polyester Enclosures*
						Surface Mount	Bootless Operator Station†	
						Cat. No.	Cat. No.	Cat. No.
One Push Button	 1 N.O. - 1 N.C.	Momentary	Flush	Green	START	800R-1TB	800R-1HB4TL	800R-1HB4RL
			Extended	Red	STOP	800R-1TA	800R-1HA4TL	800R-1HA4RL
			Flush	Black	No Legend	800R-1TX	800R-1HX4TL	800R-1HX4RL
Two Push Buttons	 1 N.O. - 1 N.C. Each Button	Momentary	Flush Extended	Green Red	START STOP	800R-2TA	800R-2HA4TL	800R-2HA4RL
			Flush Flush	Black Black	No Legend No Legend	800R-2TX	800R-2HX4TL	800R-2HX4RL
One Pilot Light, Two Push Buttons	 1 N.O. - 1 N.C. Each Button	Momentary	120V AC Flush Extended	Red Green Red	No Legend START STOP	800R-2TAR	800R-2HAR4TL	800R-2HAR4RL
			120V AC Flush Flush	Red Black Black	No Legend No Legend No Legend	800R-2TXR	800R-2HXR4TL	800R-2HXR4RL
3-Position Selector Switch	 1 N.O. - 1 N.C.	Maintained	Knob Lever	Black with white insert	HAND OFF AUTO	800R-R3TA	800R-R3HA4TL	<b>800R-R3HA4RL</b>
			Knob Lever	Black with white insert	No Legend	800R-R3TX	800R-R3HX4TL	800R-R3HX4RL
One Push Button	 1 N.O. - 1 N.C.	Maintained	Push-Pull/Twist	Red	EMRG.STOP	<b>800R-1TAM</b>	800R-1HAM4TL	800R-1HAM4RL
Two Push Buttons	 1 N.O. - 1 N.C. Each Button	Maintained	Flush Extended	Green Red	START STOP	800R-2TAM	800R-2HAM4TL	800R-2HAM4RL
			Flush Flush	Black Black	No Legend No Legend	800R-2TXM	800R-2HXM4TL	800R-2HXM4RL

\* Type 4/13.

\* Type 4/4X/13.

† To order a control station with booted operators, remove the L from the end of the catalog number.

Example: Cat. No. 800R-1HA4TL becomes Cat. No. 800R-1HA4T.

# 30.5 mm Push Button Stations Hermetically Sealed for Division 2/Zone 2

## Product Selection

### Custom-Built Stations



#### Description

The tables on page 10-191 list the most commonly used push button stations. Stations not listed in the table may be ordered as custom-built stations.

#### Cat. No.

The cat. no. used to identify custom-built Bulletin 800R push button stations, which are built at the factory, will be cat. nos. listed for the enclosure only, except letter **W** will be substituted for the letter **Z** and with a station serial number.

#### Ordering Information

The following information is required when ordering custom built push button stations.

1. Cat. no. of enclosure.
2. Cat. no. of control units.
3. Legend plate cat. no. and/or marking for each unit.
4. Specify vertical or horizontal mounting.
5. Specify desired operator mounting sequence. Inclusion of a sketch is recommended. If no information is given, standard configuration will be used.

### Enclosures Only



Die Cast  
Cat. No. 800R-2TZ



Stainless Steel  
Cat. No. 800R-2HZ4



Rosite Glass Polyester  
Cat. No. 800R-2HZ4R

Units*	Die Cast (Type 4/13)	Stainless Steel (Type 4/4X/13)	Rosite Glass Polyester (Type 4/4X/13)
	Cat. No.	Cat. No.	Cat. No.
1	800R-1TZ	800R-1HZ4	800R-1HZ4R
2	800R-2TZ	800R-2HZ4	800R-2HZ4R
3	800R-3TZ	800R-3HZ4	800R-3HZ4R
4	800R-4TZ	800R-4HZ4	800R-4HZ4R
5	—	800R-5HZ4	—
6	800R-6TZ	800R-6HZ4	800R-6HZ4R

\* Number of units that can be mounted in enclosure.

\* Extra deep. Accommodates two levels of stackable sealed switch contact blocks.

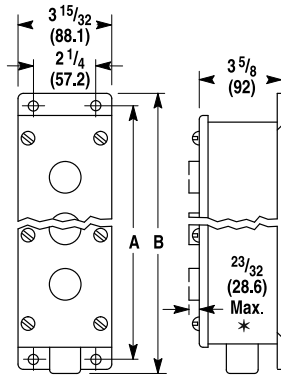
**Note:** Enclosure and conduit dimensions are detailed on page 10-193, except for the fiberglass enclosures, which are found on 10-64.

# 30.5 mm Push Button Stations Hermetically Sealed for Division 2/Zone 2

## Product Overview

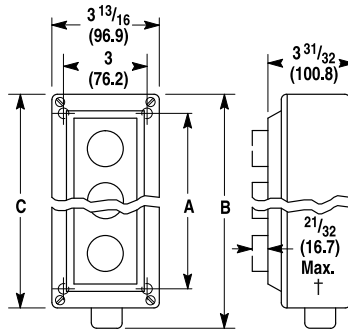
### Approximate Dimensions and Shipping Weights

Dimensions in inches (millimeters). Dimensions are not intended to be used for manufacturing purposes.



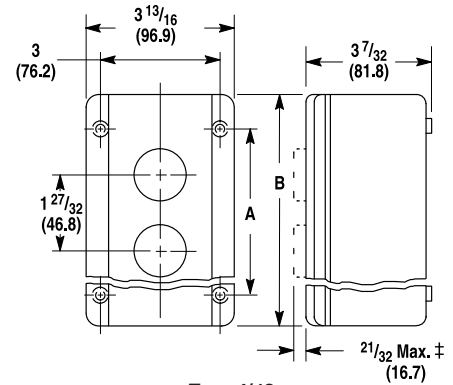
**Type 4/4X/13  
Stainless Steel**

**Watertight/Oiltight/Corrosion-Resistant  
Enclosure**



**Type 4/4X/13  
Rosite Glass Polyester**

**Watertight/Oiltight/Corrosion-Resistant Enclosure**

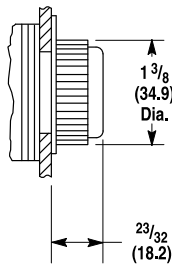


**Type 4/13  
Cast Aluminum Enclosure**  
**Watertight/Oiltight**

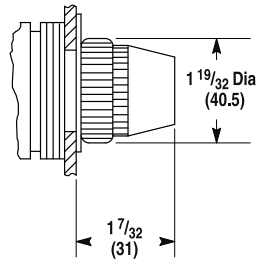
Dimension	Number of Units					
	1	2	3	4	5	6
<b>Stainless Steel Type 4/4X/13</b>						
A	5-5/32 (135)	7 (178)	8-27/32 (225)	10-11/16 (271)	12-17/32 (318)	14-3/8 (360)
B	6-13/32 (163)	8-1/4 (210)	10-1/8 (257)	11-31/32 (304)	14-1/32 (359)	15-7/8 (403)
Pipe Tap Size	3/4				1	
<b>Glass Polyester Type 4/4X/13</b>						
A	4-1/2 (114)	4-1/2 (114)	6-1/4 (159)	8 (203)	12-1/8 (308)	12-1/8 (308)
B	7-1/32 (181)	7-1/32 (181)	8-23/32 (221)	10-21/32 (271)	14-7/8 (378)	14-7/8 (378)
C	5-7/8 (149)	5-7/8 (149)	7-9/16 (192)	9-1/2 (241)	13-1/2 (343)	13-1/2 (343)
Pipe Tap Size	3/4				1	
<b>Cast Aluminum Type 4/13</b>						
A	2-3/4 (69.8)	4-1/2 (114)	6-1/4 (159)	8 (203)	—	12-1/8 (308)
B	4-3/16 (106)	5-7/8 (149)	7-9/16 (192)	9-1/2 (241)	—	13-1/2 (343)
Conduit Opening	3/4 in. 14 N.P.T.				—	1 in. 11-1/2 N.P.T.

- \* Selector switch is 1-5/32 (29.4) maximum; pilot light is 1-7/32 (31).
- ⊛ Selector switch is 1-3/32 (27.8) maximum; pilot light is 1-5/32 (29.4) maximum.
- ‡ Selector switch is 1-7/32 (30.9) maximum; pilot light is 1-9/32 (32.5).
- § Minimum vertical spacing dimension for jumbo legend plate is 2-15/32 (62.7).

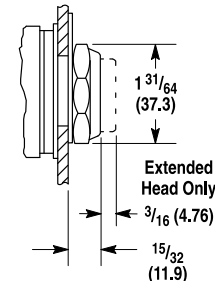
### Operator Extension in Front of Panel\*



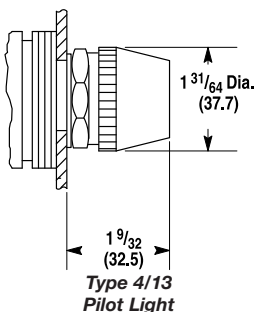
**Type 4/4X/13  
Booted Flush and Extended Head Push Button**



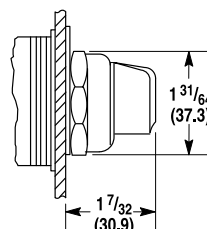
**Type 4/4X/13  
Pilot Light**



**Type 4/13 and Type 4/4X/13  
Bootless Flush and Extended Head Push Button**

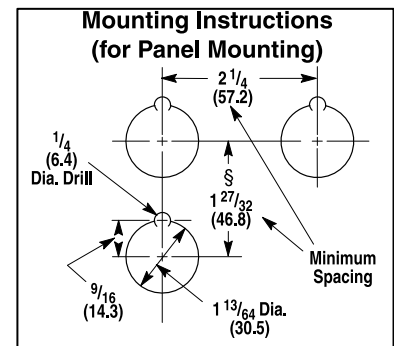


**Type 4/13  
Pilot Light**



**Type 4/13 and Type 4/4X/13  
Standard Knob Selector Switches**


### Mounting Instructions (for Panel Mounting)



\* See 10-49...10-56 for additional Type 4/13 outlines and for additional Type 4/4X/13 outlines.

# Hazardous Location Push Buttons

## Product Overview/Specifications

	<p><b>Bulletin 800G — Hazardous Location Push Buttons</b></p> <ul style="list-style-type: none"> <li>• IP66, Type 4X</li> <li>• Class I, Zone 1 and Zone 2</li> <li>• Class I/Division 2 — Groups A, B, C, and D</li> </ul>	<p><b>Table of Contents</b></p> <p>See below.</p>
---	---	---


### TABLE OF CONTENTS

Description	Page
Complete Assembled Stations .....	10-197
Push Buttons .....	10-199
Mushroom .....	10-199
Key Release .....	10-200
Selector Switch .....	10-200
Pilot Light .....	10-201

Description	Page
Ammeter .....	10-201
Enclosures .....	10-201
Back-of-Panel Components .....	10-202
Accessories .....	10-203
Legend Plates .....	10-204
Approximate Dimensions .....	10-207

### Specifications

#### Standard Assembled Stations

	Mechanical Ratings
Protection Type	 II 2G Ex edm IIC T6 AEx edm IIC T6 Ex edm IIC T6
Certification	PTB 01 ATEX 1036 UL E10314 CE0044
Rated Insulation Voltage	Max. 690V AC
Rated current	Dependent on components used
Degree of Protection	IP66, Type 4X: -20...+60 °C (-4...+140 °F) IP54: -55...+60 °C (-67...+140 °F)
Enclosure Material	
Enclosure	Thermoplastic
Seals	EPDM
Cable Glands	
Standard	Plastic M20 x 1.5 for cable Ø 6...12 mm
Custom	Plastic M25 for cable Ø 13...18 mm 1/2 in. NPT conduit 3/4 in. NPT conduit
Wire/Cable Size	2.5 mm <sup>2</sup> (12 AWG) stranded max.
PE Conductor Terminals	4 x 2.5 mm <sup>2</sup> (12 AWG) stranded max.
Storage Temperature	-55...+70 °C (-67...+158 °F)
Operational Temperature Range	-55...+60 °C (-67...+140 °F)

#### Assembled Stations

Bulletin 800G control stations are designed for Class I, Zone 1 and 2 and Class I/Division 2 hazardous location applications. They consist of Bulletin 800G front-of-panel components with back-of-panel components: contact blocks or power modules. Bulletin 800G units are available as factory assembled stations or as components for component replacement. Field assembled stations used in a Class I, Zone 1 or Zone 2 application must be inspected and certified by a third party.

#### Components

Since the back-of-panel components are enclosed in a flame-proof enclosure, they are suitable for use in **Class I, Zone 1 and Zone 2 Groups IIA, IIB, and IIC and Class I/Division 2, Groups A, B, C, and D hazardous locations and is listed by Underwriters Laboratories and certified by PTB for this class of service.** The components have “d” and “e” protection methods except for the cable termination. Cable termination has only “d” protection method, restricted by the cable and not the contacts.





**CAUTION:**  
The assembled stations and individual components listed herein are not suitable for the use in Zone 0, Class I/Division 1 and Class II/Division 1 and Division 2 applications. For Class I and II/Division 1 hazardous locations, order Bulletin 800H Type 7 & 9 stations and units. For Class II/Division 2 hazardous locations, order Bulletin 800R stations.





**Back-of-Panel**

**Contact Block**

Electrical Ratings						
	Screw Termination			Cable Termination		
Rated Insulation Voltage	690V			400V (Limited by the cable, not the contacts)		
Rated Voltage	250V (per ATEX certificates)		24V	250V (per ATEX certificates)		24V
Rated Operating Currents	16 A	10 A	1 A	16 A	10 A	1 A
Utilization Category	AC-12	AC-15	DC-13	AC-12	AC-15	DC-13
Thermal Continuous Current	16 A at 40 °C (104 °F), 11 A at 60 °C (140 °F)			16 A at 40 °C (104 °F), 11 A at 60 °C (140 °F)		
Contact Rating per UL 508	A600		P600	A600		P600
Max. Rated Voltage per UL Contact Rating	600V		600V	600V		600V
Max. "Make" Current at Rated Voltage per UL Contact Rating	12 A		0.2 A	12 A		0.2 A
Max. "Break" Current at Rated Voltage per UL Contact Rating	1.2 A		0.2 A	1.2 A		0.2 A
Thermal Continuous Test Current per UL Contact Rating	10 A		5 A	10 A		5 A
Short Circuit Protection	10 A Slow Blow, Type DT, gl			10 A Slow Blow, Type DT, gl		
Mechanical Ratings						
Protection Type	 II 2G Ex de IIC Class I, Zone 1 AEx de IIC Class I, Zone 1 Ex de IIC			 II 2G Ex d IIC T6 Class I, Zone 1 AEx d IIC T6 Class I, Zone 1 Ex d IIC T6		
Certification	PTB 01 ATEX 1040U UL E10314			PTB 01 ATEX 1039X UL E10314		
Contact Options	1 N.O. - 1 N.C. 2 N.O. 2 N.C.			1 N.O. - 1 N.C. 2 N.O. 2 N.C.		
Contact Material	AgSnO <sub>2</sub>			AgSnO <sub>2</sub>		
Housing Material	Thermoplastic			Thermoplastic		
Physical Shock Resistance	DIN IEC 68 part 2-27, 30 g 18 ms			DIN IEC 68 part 2-27, 30 g 18 ms		
Design Life	1 000 000 cycle mechanical life			1 000 000 cycle mechanical life		
Operating Force (Maximum)	22.2 N (5 lb) to open N.C. 15.6 N (3.5 lb) to close N.O. 28.9 N (6.5 lb) full travel			22.2 N (5 lb) to open N.C. 15.6 N (3.5 lb) to close N.O. 28.9 N (6.5 lb) full travel		
Temperature (Storage/Transport)	-55...+70 °C (-67...+158 °F)			-55...+70 °C (-67...+158 °F)		
Operational Temperature Range	-55...+60 °C (-67...+140 °F)			-55...+60 °C (-67...+140 °F)		
Wire/Cable Size	2.5 mm <sup>2</sup> (12 AWG) stranded max.			3 m (9.8 ft) long cable 4 x 1.5 mm <sup>2</sup> (9.1 mm/0.36 in. OD)		
Degree of Protection	IP20, with operators and enclosure IP66			With operators IP67		
Mounting	Base Mount: Secures to rail integral to enclosure base Panel Mount: Secures to operator with integral latch			Panel Mount: Secures to operator with integral latch		

**Power Module**

Electrical Ratings						
	Screw Termination			Cable Termination		
Rated Insulation Voltage	300V			300V		
Power Consumption	≤ 1 W			≤ 1 W		
Lamp	Multi-LED (Red, Yellow, Green, White, Blue)			Multi-LED (Red, Yellow, Green, White, Blue)		
Rated Voltage	12...60V DC 12...250V AC			24...60V DC 24...60V AC and 110...250V AC		
Mechanical Ratings						
	Screw Termination			Cable Termination		
Protection Type	 II 2G Ex de IIC Class I, Zone 1 AEx de IIC Class I, Zone 1 Ex de IIC			 II 2G Ex d IIC T6 Class I, Zone 1 AEx d IIC T6 Class I, Zone 1 Ex d IIC T6		
Certifications	PTB 01 ATEX 1037U UL E10314			PTB 01 ATEX 1038X UL E10314		
Housing Material	Thermoplastic			Thermoplastic		
Physical Shock Resistance	DIN IEC 68 part 2-27, 30 g, 18 ms			DIN IEC 68 part 2-27, 30 g, 18 ms		
Design Life	100 000 hours			100 000 hours		
Storage/Transport Temperature	-55...+70 °C (-67...+158 °F)			-55...+70 °C (-67...+158 °F)		
Ambient Temperature Range	-55...+60 °C (-67...+140 °F)			-55...+60 °C (-67...+140 °F)		
Wire/Cable Size	2.5 mm <sup>2</sup> (12 AWG) stranded max.			3 m (9.8 ft) long cable 4 x 1.5 mm <sup>2</sup> (9.1 mm/0.36 in. OD)		
Degree of Protection	IP20, with operators and enclosure IP66			With operators IP67		
Mounting	Base Mount: Secures to rail integral to enclosure base Panel Mount: Secures to operator with integral latch			Panel Mount: Secures to operator with integral latch		





# Hazardous Location Push Buttons


## Specifications

### Back-of-Panel, Continued

#### Power Module/Contact Block Combination

Electrical Ratings				
	Screw Termination		Cable Termination	
Rated Insulation Voltage	300V		300V	
Power Consumption	≤ 1 W		≤ 1 W	
Lamp	Multi-LED (red, yellow, green, white, blue)		Multi-LED (red, yellow, green, white, blue)	
Rated Voltage	24...48V DC 24...250V AC		24...48V DC 24...250V AC	
Contact Rating per UL 508	A600	P600	A600	P600
Thermal Continuous Current	1 A	0.25 A	1 A	0.25 A
Max. Rated Voltage	600V	600V	600V	600V
Mechanical Ratings				
	Screw Termination		Cable Termination	
Protection Type	 II 2G EEx de IIC Class I, Zone 1 AEx de IIC Class I, Zone 1 Ex de IIC		 II 2G EEx d IIC T6 Class I, Zone 1 AEx d IIC T6 Class I, Zone 1 Ex d IIC T6	
Certifications	PTB 01 ATEX 1037U UL E10314		PTB 01 ATEX 1038X UL E10314	
Housing Material	Thermoplastic		Thermoplastic	
Physical Shock Resistance	DIN IEC 68 part 2-27, 30 g, 18 ms		DIN IEC 68 part 2-27, 30 g, 18 ms	
Design Life	100 000 hours		100 000 hours	
Storage/Transport Temperature	-55...+70 °C (-67...+158 °F)		-30 ...+70 °C (-22...+158 °F)	
Ambient Temperature Range	-55...+60 °C (-67...+140 °F)		-30...+60 °C (-22...+140 °F)	
Wire/Cable Size	2.5 mm <sup>2</sup> (12 AWG) stranded max.		3 m (9.8 ft) long cable 4 x 1.5 mm <sup>2</sup> (9.1 mm/0.36 in. OD)	
Degree of Protection	IP20, with operators and enclosure IP66		With operators IP67	
Mounting	Base Mount: Secures to rail integral to enclosure base Panel Mount: Secures to operator with integral latch		Panel Mount: Secures to operator with integral latch	







### Front-of-Panel Operators

Mechanical Ratings							
Device	Operational Temperature	Operating Force *	Mechanical Design Life	Impact Resistance	Materials	Ingress Protection	Ex Protection Type
Push Button	-55...+70 °C (-67...+158 °F)	6.7 N (1.5 lb)	1 000 000 cycles	7 N•m	Thermoplastic Housing EPDM Seals	IP66 : -20...+70 °C (-4...+158 °F)	 II 2G EEx e II PTB 01 ATEX 1035U UL E10314
Selector Switch	-55...+70 °C (-67...+158 °F)	—					
Key Release Push Button	-55...+70 °C (-67...+158 °F)	15.6 N (3.5 lb)					
Key Release Mushroom	-55...+70 °C (-67...+158 °F)	15.6 N (3.5 lb)					
Mushroom	-55...+70 °C (-67...+158 °F)	6.7 N (1.5 lb)					
E-Stop	-55...+70 °C (-67...+158 °F)	44.5 N Push/ 89 N Pull (10 lb Push/ 20 lb Pull)	6000 cycles			IP54: -55...-20 °C (-67...-4 °F)	
Pilot Light (Red, Yellow, White, Green, Blue)	-55...+70 °C (-67...+158 °F)	—	N/A	4 N•m		Type 4X: -20...+70 °C (-4...+158 °F)	
Hole Plug	-55...+70 °C (-67...+158 °F)	—	N/A	7 N•m			
Illuminated Push Button	-55...+70 °C (-67...+158 °F)	6.7 N (1.5 lb)	1 x 10 <sup>6</sup>	7 N•m			
Key Selector Switch	-55...+70 °C (-67...+158 °F)	—	1 000 000 cycles	7 N•m			

\* Does not include contact block.



**Product Selection**  
**Complete Assembled Stations**

Enclosure Type	Button Type/Color	Legend Marking	Cat. No.
One-hole 	Black push button	No legend	800G-1F2A3
	E-Stop	Emergency Stop/Arrêt D'urgence	800G-1E4A3
	Mushroom key release	No legend	800G-1B4A3
Cat. No. 800G-1E4A3 Two-hole 	2-position maintained selector switch	No legend	800G-1HMA3
Two-hole 	2 black push buttons	No legends	800G-2F2AF2A3
	Green push button Red push button	No legends	800G-2F3AF4A3
	Green push button Red push button	START STOP	800G-2FAAFBA3
Three-hole 	Red LED Green push button Red push button	No legends	800G-3P4DF3AF4A3
	Red LED Green push button Red push button	No legend START STOP	800G-3P4DFAAFBA3
	Green push button Red push button E-Stop push/pull	No legend No legend Emergency Stop/Arrêt D'urgence	800G-3F3AF4AE4A3
	Green push button Red push button E-Stop push/pull	START STOP Emergency Stop/Arrêt D'urgence	800G-3FAAFBAE4A3
	Cat. No. 800G-3P4DF3AF4A3 Ammeter + 1 operator 	1 A ammeter 2-position maintained selector switch	No legends
Cat. No. 800G-3M1XHMA3 Ammeter + 1 operator 	5 A ammeter 2-position maintained selector switch	No legends	800G-3M5XHMA3

# Hazardous Location Push Buttons

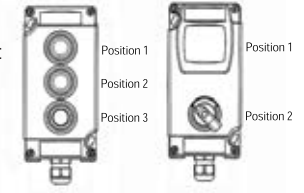
## Product Selection

### Complete Assembled Stations, Continued

800G – 2 F 3 M F 4 N 3

*a* *b* *c* *d* *b* *c* *d* *b* *c* *d* *e*

*a* *c* *e*



Enclosure Size	
Code	Description
1	1-hole
2	2-hole
3	3-hole

Operator/Meter	
Code	Description
B	Key release mushroom push button*
D	Momentary mushroom push button*
E	Push-pull mushroom push button*
F	Non-illuminated flush push button*
H	2-position selector switch*
J	3-position selector switch*
K	Key release push button
L	Illuminated push button — flush*
M	Ammeter§
N	Hole plug*
P	Pilot light*

- \* Only available in red.
- ⊛ Only available in black.
- § For ammeter, choose 3-hole enclosure with meter in pos. 1 and either an operator or hole plug in pos. 2 (i.e., Cat. No. 800G-3 M1X J1A or Cat. No. 800G-3 M1X N2X)
- ♣ Only available in white, green, red, yellow, and blue.
- ⌘ Only available for 3-position selector switch.
- ⬆ For through-feed enclosure, selected conduit entry will be applied for both bottom and top entry.
- ⚡ For use with illuminated push button only.
- ♣ Only available in white, black, green, red, or yellow.

Push Button Color/Text	
Code	Description
1	White
2	Black
3	Green
4	Red
5	Yellow
6	Blue
A	START (green background/white text)
B	STOP (red background/white text)
G	I (green background/white text)
H	O (red background/white text)
J	ON (green background/white text)
K	OFF (red background/white text)
Key Release	
1	Lockable in initial position, key removal in initial position
2	Lockable in both positions, key removal in both positions
3	Lockable in depressed position, key removal in depressed position
Selector Switch	
M	Maintained in all positions
B	Spring return from both positions⌘
L	Spring return from left⌘
R	Spring return from right⌘
Meters§	
1	1 A
5	5 A

Contact Block/Lamp Module	
Code	Description
A	1 N.O. - 1 N.C. base mount
M	2 N.O. base mount
N	2 N.C. base mount
D	Lamp module base mount (same color as requested lens color in Table c)
X	N/A (i.e., ammeter, hole plug)
K	1 N.O. with lamp module⚡
L	1 N.C. with lamp module⚡

Conduit Entry	
Bottom Entry	
Code	Description
Blank	M20X1.5 threaded hole
1	1/2 in. NPT conduit hub
2	3/4 in. NPT conduit hub
3	1 M20 plastic cable gland for cable diameter 6...12 mm
4	1 M25 plastic cable gland for cable diameter 13...18 mm
5	M20 blind plug
6	M25 blind plug
7	2 M20 plastic cable gland
8	1 M20 metal cable gland
9	1 M25 metal cable gland
0	2 M20 metal cable gland
Top Entry	
A	M20X1.5 threaded hole
B	1/2 in. NPT conduit hub
C	3/4 in. NPT conduit hub
D	1 M20 plastic cable gland for cable diameter 6...12 mm
E	1 M25 plastic cable gland for cable diameter 13...18 mm
F	M20 blind plug
G	M25 blind plug
H	2 M20 plastic cable gland
J	1 M20 metal cable gland
K	1 M25 metal cable gland
L	2 M20 metal cable gland
Through Feed⬆	
M	M20X1.5 threaded hole
N	1/2 in. NPT conduit hub
P	3/4 in. NPT conduit hub
Q	1 M20 plastic cable gland for cable diameter 6...12 mm
R	1 M25 plastic cable gland for cable diameter 13...18 mm
T	M20 blind plug
U	M25 blind plug
V	2 M20 plastic cable gland
W	1 M20 metal cable gland
X	1 M25 metal cable gland
Y	2 M20 metal cable gland

## Push Button, Non-Illuminated — Flush



Cat. No. 800G-F3

Flush-Round	
Color	Cat. No.
White	800G-F1
Black	800G-F2
Green	800G-F3
Red	800G-F4
Yellow	800G-F5

800G -  $\frac{F}{a}$   $\frac{3}{b}$

Operator Construction	
Code	Description
F	Flush operator

Color	
Code	Description
1	White
2	Black
3	Green
4	Red
5	Yellow

## Double Push Button, Non-Illuminated — Flush



Cat. No. 800G-U2FX



Cat. No. 800G-V2FX

Description	Cat. No.*
Double push button with curved base for use with Bul. 800G enclosures.	800G-U2FX
Double push button with flat base for use with customer provided enclosures.	800G-V2FX

\* All double push buttons come with a multi-pack of color caps (red, green, black, white, and yellow).

## Push Button, Illuminated — Flush



Cat. No. 800G-LF3

Color	Cat. No.
White	800G-LF1
Green	800G-LF3
Red	800G-LF4
Yellow	800G-LF5
Blue	800G-LF6

800G -  $\frac{LF}{a}$   $\frac{3}{b}$

Operator Construction	
Code	Description
LF	Illuminated flush operator

Color	
Code	Description
1	White
3	Green
4	Red
5	Yellow
6	Blue

## Mushroom — Non-Illuminated and Key Release



Momentary Mushroom  
Cat. No. 800G-M2



Key Release Mushroom  
Cat. No. 800G-MKE



Push-Pull Mushroom  
Cat. No. 800G-MPE

Color/Feature	Momentary Mushroom	Key Release Mushroom	Push-Pull
	Cat. No.	Cat. No.	Cat. No.
Black w/black bezel	800G-M2	—	—
E-Stop red w/ yellow bezel *	—	800G-MKE	800G-MPE

800G -  $\frac{M}{a}$   $\frac{2}{b}$

Operator Style	
Code	Description
M	Momentary
* MP	Push-pull
* MK	Key release

Color or Feature	
Code	Color
2	Black with black bezel
E	Red E-stop with yellow bezel and printing on head

\* Only available in E-stop, option E from Table b.

# Hazardous Location Push Buttons

## Product Selection

### Key Release



Cat. No. 800G-K14

Operator Style	Locking Position	Cat. No.
Key Release Push Button	Lockable in initial position, key removal in initial position	800G-K14
	Lockable in both positions, key removal in both positions	800G-K16
	Lockable in depressed position, key removal in depressed position	800G-K24

800G -                      
           a      b  
                   a

Operator Style	
Code	Description
K	Key release push button

b

Locking Position	
Code	Description
14	Lockable in initial position; key removal in initial position
16	Lockable in both positions; key removal in both positions
24	Lockable in depressed position; key removal in depressed position

### Selector Switch — Knob & Key Operated



Knob Selector Switch  
 Cat. No. 800G-SM3



Key Operated Switch  
 Cat. No. 800G-KSM33H

800G -                      
           a      b      c      d  
                   a

Operator Style	
Code	Description
S	Knob
KS	Key operated

b

No. of Positions/Functions	
Code	Description
M2	2-position maintained
B3	3-position spring return left and right to center
L3	3-position spring return left to center
M3	3-position maintained
R2	2-position spring return right to left
R3	3-position spring return right to center

c

Key Removal	
Code	Description
Blank	For knob selector switches
* 1	Left
* 2	Right
* 3	All
* 4	Center
* 5	Left/center
* 6	Left/right
* 7	Right/center

d

Knob Position	
Code	Description
* Blank	For latch mount or base mount in horizontal Bul. 800G enclosure
H	For base mount in vertical Bul. 800G enclosure

\* Only available with key selector (Code **KS** from Table a).  
 \* Only available with knob selector (Code **S** from Table a).

### 2-Position Target Table

Contact Type		
N.O.	O	X
N.C.	X	O

### 3-Position Target Table

Contact Type	Pos. on Latch or Base			
N.O.	Top	O	O	X
	Bottom	X	O	O
N.C.	Top	X	X	O
	Bottom	O	X	X

Operator Style	Positions/Functions	Knob Selector Switch	
		Cat. No.	
2-Position	Maintained	800G-SM2	
	S→M←S	800G-SB3	
3-Position	S→M M	800G-SL3	
	Maintained	800G-SM3	
	M M←S	800G-SR3	

Operator Style	Positions/Functions	Key Removal Position	Key Operated Switch
			Cat. No.
2-Position	Maintained	All	800G-KSM23H
	S→M←S	Center	800G-KSB34H
3-Position	S→M M	Right/center	800G-KSL37H
	Maintained	All	800G-KSM33H
	M M←S	Left/center	800G-KSR35H

# Hazardous Location Push Buttons

Product Selection

## Pilot Light



Cat. No. 800G-P3

Operator Style	Color	Cat. No.
Pilot Light	White	800G-P1
	Green	800G-P3
	Red	800G-P4
	Yellow	800G-P5
	Blue	800G-P6

800G -  $\frac{P}{a}$   $\frac{3}{b}$   
 $\frac{a}{a}$

Operator Style	
Code	Description
P	Pilot light

$\frac{b}{b}$

Lens Color	
Code	Color
1	White
3	Green
4	Red
5	Yellow
6	Blue

## Ammeter



Cat. No. 800G-AMP1B

Base Mount	
Amperage*	Cat. No.
1 A	800G-AMP1B
5 A	800G-AMP5B

\* Unit ships with a percent scale plate.

## Enclosures — Plastic\*

Base mount only



Cat. No. 800G-1P

Type	Type	
	M20 Threaded Hole — Bottom Feed	3/4 in. Conduit — Bottom Feed
Type	Cat. No.	Cat. No.
1-Hole	800G-1P	800G-1P2
2-Hole	800G-2P	800G-2P2
3-Hole	800G-3P	800G-3P2
Ammeter Station	800G-3PA	800G-3PA2

\* Bul. 800G enclosures are base mount only and will only work with base mount contact blocks.

800G -  $\frac{3}{a}$   $\frac{P}{b}$   $\frac{T}{c}$   $\frac{1}{d}$

$\frac{a}{a}$

Enclosure Size	
Code	Description
1	1-hole
2	2-hole
3	3-hole

$\frac{b}{b}$

Enclosure Style	
Code	Description
P	Plastic
PA	Plastic with ammeter window*

\* Only available in Enclosure Size 3.

$\frac{c}{c}$

Conduit Entry	
Code	Description
Blank	Bottom feed
T	Top feed
F	Through feed
X	No holes

$\frac{d}{d}$

Conduit Style	
Code	Description
Blank	M20 x 1.5 threaded hole
1	1/2 in. NPT conduit hub
2	3/4 in. NPT conduit hub
3	M20 plastic cable gland
4	M25 plastic cable gland
5	M20 blind plug
6	M25 blind plug
7	Two M20 plastic cable glands
8	M20 metal cable gland
9	M25 metal cable gland
0	Two M20 metal cable glands

# Hazardous Location Push Buttons

## Product Selection

### Back-of-Panel Components

#### Latch and Base Mount Contact Block



Base Mount  
Cat. No. 800G-XBA



Latch Mount Screw Termination  
Cat. No. 800G-XLSA

Contact	Base Mount		Latch Mount	
	Screw Termination		Screw Termination	Cable Termination
	Cat. No.		Cat. No.	Cat. No.
1 N.O. - 1 N.C.	800G-XBA		800G-XLSA	800G-XLC3A
2 N.O.	800G-XBM		800G-XLSM	800G-XLC3M
2 N.C.	800G-XBN		800G-XLSN	800G-XLC3N

#### Latch Mount and Base Mount Power Module\*



Base Mount  
Cat. No. 800G-DBG



Latch Mount Screw Termination  
Cat. No. 800G-DLSG

Color	Base Mount		Latch Mount	
	Screw Termination		Screw Termination	Cable Termination
	Cat. No.		Cat. No.	Cat. No.
White	800G-DBW		800G-DLSW	800G-DLC3W
Green	800G-DBG		800G-DLSG	800G-DLC3G
Red	800G-DBR		800G-DLSR	800G-DLC3R
Yellow	800G-DBY		800G-DLSY	800G-DLC3Y
Blue	800G-DBB		800G-DLSB	800G-DLC3B

**Note:** Cable termination length is three meters.

#### Power Module with Contact Block\*



Latch Mount  
Cat. No. 800G-DBGXK

Color	Latch Mount	
	1 N.O.	1 N.C.
	Cat. No.	Cat. No.
White	800G-DLSWXK	800G-DLSWXL
Green	<b>800G-DLSGXK</b>	800G-DLSGXL
Red	800G-DLSRXK	800G-DLSRXL
Yellow	800G-DLSYXK	800G-DLSYXL
Blue	800G-DLSBXK	800G-DLSBXL

**Note:** For use with illuminated push button.

### 800G – XLS A

a b  
a

Contact Block/Latch Type	
Code	Description
XB	Base mount
XLS	Latch mount with screw termination
XLC3	Latch mount with 3 m (9.84 ft) cable termination

b

Contact Configuration	
Code	Description
A	1 N.O. - 1 N.C.
M	2 N.O.
N	2 N.C.

### 800G – DB G

a b  
a

Power Module/Latch Type	
Code	Description
DB	Base mount
DLS	Latch mount with screw termination
DLC3	Latch mount with 3 m (9.84 ft) cable termination

b

Color	
Code	Description
W	White
G	Green
R	Red
Y	Yellow
B	Blue

\* Bul. 800G LED modules can only be powered from dry contact circuits (with no leakage current in the OFF state).

### 800G – DB G XK

a b c  
a

Power Module/Latch Type	
Code	Description
DB	Base
DLS	Latch mount with screw termination
DLC3	Latch mount with 3 m (9.84 ft) cable termination

b

Color	
Code	Description
W	White
G	Green
R	Red
Y	Yellow
B	Blue





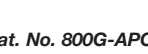












c

Contact Configuration	
Code	Description
XK	1 N.O.
XL	1 N.C.

\* Bul. 800G LED modules can only be powered from dry contact circuits (with no leakage current in the OFF state).

## Accessories

	Description	Pkg. Qty.	Cat. No.
	1/2 in. NPT Conduit Hub	1	<b>800G-ACH1</b>
<b>Cat. No. 800G-ACH2</b>	3/4 in. NPT Conduit Hub	1	800G-ACH2
	M20 Plastic Cable Gland (6...12 mm)	10	<b>800G-ACG1</b>
<b>Cat. No. 800G-ACG1</b>			
	M25 Plastic Cable Gland (13...18 mm)	10	800G-ACG3
<b>Cat. No. 800G-ACG3</b>			
	M20 Metal Cable Gland	10	800G-ACG5
<b>Cat. No. 800G-ACG5</b>			
	M20S Metal Cable Gland	10	800G-ACG7
<b>Cat. No. 800G-ACG7</b>			
	M25 Metal Cable Gland	10	800G-ACG6
<b>Cat. No. 800G-AEB</b>	Earth Bracket	10	800G-AEB
	Earth Plate 1 M20	10	800G-AEP1
<b>Cat. No. 800G-AEP1</b>			
	Earth Plate 2 M20	10	800G-AEP2
<b>Cat. No. 800G-AEP2</b>			
	Earth Plate M25	10	800G-AEP3
<b>Cat. No. 800G-AEP3</b>			
	M20 Stopping Plug	10	800G-AM20P
<b>Cat. No. 800G-AM20P</b>			
	M25 Stopping Plug	10	800G-AM25P
<b>Cat. No. 800G-AM25P</b>			

	Description	Pkg. Qty.	Cat. No.
	Mounting Nut	10	800G-AMN1
<b>Cat. No. 800G-AMNI</b>			
	10-printed push button inserts: Green "START"	10	800G-APC1
	10-printed push button inserts: Green "ON"	10	800G-APC2
	10-printed push button inserts: Green "I"	10	800G-APC3
	10-printed push button inserts: Red "STOP"	10	800G-APC4
	10-printed push button inserts: Red "OFF"	10	800G-APC5
	10-printed push button inserts: Red "O"	10	800G-APC6
<b>Cat. No. 800G-APC_</b>			
	Mounting Ring Wrench	10	<b>800G-AW1</b>
<b>Cat. No. 800G-AW1</b>			
	90 mm yellow legend plate for E-Stop	10	<b>800G-AEL90</b>
<b>Cat. No. 800G-AEL90</b>			
	Flange set for connecting 2 enclosures	—	800G-AFS
<b>Cat. No. 800G-AFS</b>			
	Locking cover with 30 mm hole for securement by bezel	—	800G-ALCB
	White color cap insert	10	800G-ACC1
	Black color cap insert	10	800G-ACC2
	Green color cap insert	10	800G-ACC3
	Red color cap insert	10	800G-ACC4
	Yellow color cap insert	10	800G-ACC6
<b>Cat. No. 800G-ACC_</b>			
	Contact block and power module ID blank label	10	800G-ACC7
<b>Cat. No. 800G-ACC7</b>			
	Black Hole Plug	—	<b>800G-N2</b>
<b>Cat. No. 800G-N2</b>			



# Hazardous Location Push Buttons

## Accessories

### Legend Plate

Type	Description	Legend Plate without Text*	Legend Plate with Text*
		Cat. No.	Cat. No.
Legend plate frame with adhesive back legend plate, 30 x 4 mm*	Silver background with black legend text	800G-11SE100	800G-11SxxxxK
Adhesive back legend plate, 30 x 4 mm	Silver background with black legend text	800G-17SE100	800G-17SxxxxK

### Legend Frame

Type	Description	Cat. No.*
Legend plate frame — snap-on, 30 x 4 mm*	Legend plate frame	800G-110

\* Not available for mushroom push buttons.

\* Minimum order quantity of 5.

800G – 11      S      E      166      K  
                          a      b      c      d      e

**a**

Type	
Code	Description
11	Legend plate and frame
17	Legend plate only

**b**

Insert Color	
Code	Description
S	Silver background with black legend text

**c**

Language	
Code	Description
E	English
F	French
G	German
T	Italian
S	Spanish
U	Universal symbol

**d**

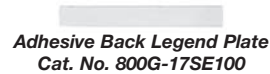
Legend Identification	
Refer to page 10-206	

**e**

Type	
Code	Description
K	0.080 size font



**Legend Frame**  
Cat. No. 800G-110



**Adhesive Back Legend Plate**  
Cat. No. 800G-17SE100

### Special Engraving

Besides the standard text and symbols listed on page 10-206, special legend plates are readily available.

To order:

- Select font code from table below.
- Specify desired text (please reference table below for restriction on characters and number of lines).

Type of Legend	Size	Font Size	Font Code	Approximate Size	Max. Characters/Line	Max. Number of Lines	Example	Example (Legend Plate with Frame)
Legend Plate	30 x 4 mm	Small	K	SAMPLE	19	1	800G-17SE100K STARTER	800G-11SE100K STARTER



**Legend Plates, Continued**

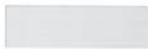
Type	Description	Legend Plate without Text*	Legend Plate with Text*
		Cat. No.	Cat. No.
Enclosure identification label, 50 x 15 mm	Silver background with black legend text	800G-AEL	800G-AEL_

\* Minimum order quantity of 5.

**800G – AEL S LINE 1 , LINE 2 , LINE 3**

*a                      b                      c                      d                      e*

<i>a</i>	<i>b</i>	<i>c, d, e</i>																
<table border="1" style="width: 100%; border-collapse: collapse;"> <thead> <tr><th colspan="2">Insert Color</th></tr> <tr><th>Code</th><th>Description</th></tr> </thead> <tbody> <tr><td>AEL</td><td>Enclosure identification label with silver background and black text</td></tr> </tbody> </table>	Insert Color		Code	Description	AEL	Enclosure identification label with silver background and black text	<table border="1" style="width: 100%; border-collapse: collapse;"> <thead> <tr><th colspan="2">Font Size</th></tr> <tr><th>Code</th><th>Description</th></tr> </thead> <tbody> <tr><td>S</td><td>0.10 size font</td></tr> <tr><td>L</td><td>0.14 size font</td></tr> </tbody> </table>	Font Size		Code	Description	S	0.10 size font	L	0.14 size font	<table border="1" style="width: 100%; border-collapse: collapse;"> <thead> <tr><th>Customized Text</th></tr> </thead> <tbody> <tr><td>Example of customer specified text based on max. characters per line and max. number of lines. When separated by a comma, the following text is to be engraved on the next line.</td></tr> </tbody> </table>	Customized Text	Example of customer specified text based on max. characters per line and max. number of lines. When separated by a comma, the following text is to be engraved on the next line.
Insert Color																		
Code	Description																	
AEL	Enclosure identification label with silver background and black text																	
Font Size																		
Code	Description																	
S	0.10 size font																	
L	0.14 size font																	
Customized Text																		
Example of customer specified text based on max. characters per line and max. number of lines. When separated by a comma, the following text is to be engraved on the next line.																		



**Blank Enclosure Identification Label**  
 Cat. No. 800G-AEL

**Special Engraving**

To order:

- Select desired font code table below (notes the max. characters and max. no. of lines).
- Specify desired text (please reference table below for restriction on characters and number of lines).

Type of Legend	Size	Font Size	Font Code	Approximate Size	Max. Characters/Line	Max. Number of Lines	Example
Enclosure ID Label	50 x 15 mm	Standard	S	SAMPLE	25	3	800G-AELS MACHINE 1, L-R27
		Large	L	SAMPLE	19	2	800G-AELL MACH 1

# Hazardous Location Push Buttons

## Legend Texts

### Universal

Marking	Suffix Number	Marking	Suffix Number
	U226	I-O-II	U234
	U227	I-II-III	U240
O	U228		U241
I	U229		U242
II	U230	III	U249
I-O	U232		U244
I-II	U233		U245
0-1-2	U285	I-O-I	U282

### English

#### One-Word Marking

Marking	Suffix Number	Marking	Suffix Number
AUTO	E101	OFF	E163
CLOSE	E107	ON	E166
DOWN	E110	OPEN	E170
EMERGENCY STOP	E112	OUT	E173
FAULT	E113	POWER ON	E178
FAST	E114	PUSH-TO-TEST	E181
FORWARD	E120	RAISE	E182
HAND	E126	RESET	E186
HIGH	E129	REVERSE	E188
IN	E132	RIGHT	E191
INCH	E134	RUN	E193
JOG	E138	SLOW	E201
LEFT	E145	START	E208
LOW	E148	STOP	E212
LOWER	E152	UP	E223

#### Two-Word Marking

Marking	Suffix Number	Marking	Suffix Number
FOR-REV	E253	LEFT-RIGHT	E146
HAND-AUTO	E127	OFF-ON	E165
HIGH-LOW	E130	OPEN-CLOSE	E171
INCH-REVERSE	E135	RAISE-LOWER	E183
JOG-FOR	E255	SLOW-FAST	E204
JOG-REV	E256	START-STOP	E211
JOG-RUN	E142	UP-DOWN	E224

#### Three-Word Marking

Marking	Suffix Number	Marking	Suffix Number
FOR-STOP-REV	E254	LOW-OFF-HIGH	E150
FOR-OFF-REV	E261	RAISE-OFF-LOWER	E184
HAND-OFF-AUTO	E128	SLOW-OFF-FAST	E205
JOG-STOP-RUN	E144	SLOW-OFF-START	E207
		HAND-O-AUTO	E283

### French

Marking	Suffix Number	Marking	Suffix Number
Auto	F101	Monter	F182
Fermer	F107	Arrière	F188
Descendre	F110	Droit	F191
Panne	F113	Régler	F198
Rapide	F114	Lent	F201
Avant	F120	Marche-Arrêt	F211
Avant-Arrêt-Arrière	F122	Hors Circuit	F244
Avant-Arrière	F124	En Circuit	F245
Manuel	F126	Hors	F246
Manuel-Auto	F127	En	F247
Manuel-Arrêt-Auto	F128	Hors-En	F248

### French, Continued

Marking	Suffix Number	Marking	Suffix Number
Haut	F129	Hors Manuel	F249
Gauche	F145	En Manuel	F250
Bas	F148	Arrêt-Manuel	F251
Bas-Arrêt-Haut	F150	Demar. Man.	F252
Arrêt	F163	Av-Hors-Arr	F253
Arrêt-Marche	F165	Surcharge	F254
Marche	F166	M Forcee	F284
Ouvrir	F170	—	—

### German

Marking	Suffix Number	Marking	Suffix Number
Zu	G107	Niedrig	G148
Ab	G110	Niedrig-Aus-Hoch	G150
Störung	G113	Senken	G152
Schnell	G114	Aus	G163
Vor	G120	Aus-Ein	G165
Vor-Aus-Zurück	G122	Ein	G166
Vor-Zurück	G124	Heben	G182
Hand	G126	Zurück	G188
Hand-Auto	G127	Rechts	G191
Hand-Aus-Auto	G128	Langsam	G201
Hoch	G129	Auf	G223
Links	G145	Betrieb	G243

### Italian

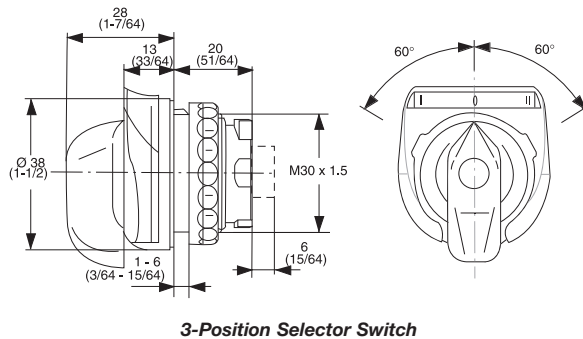
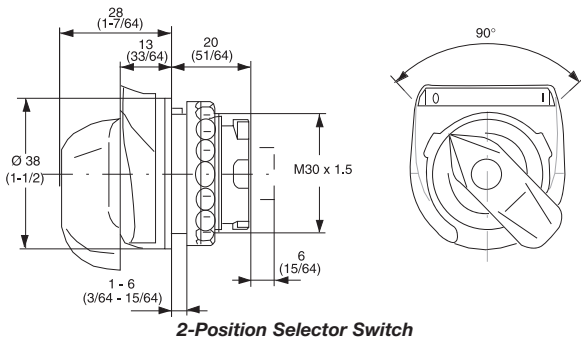
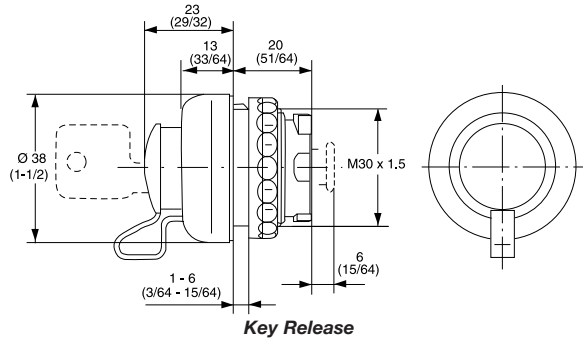
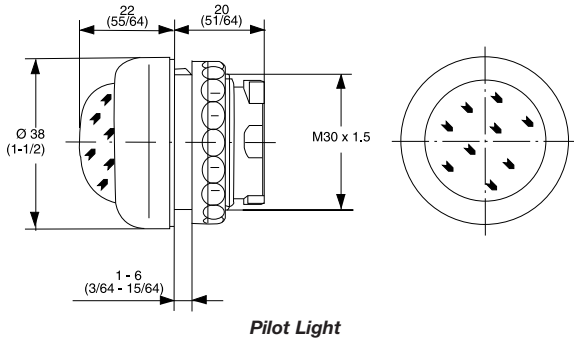
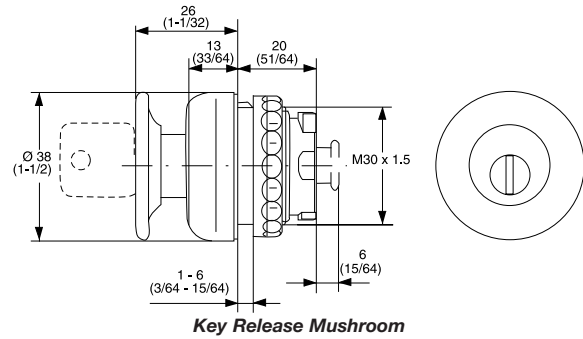
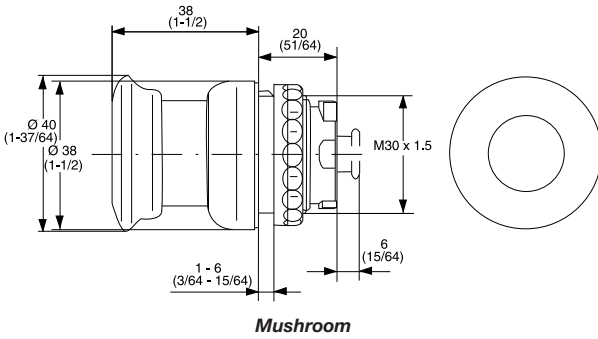
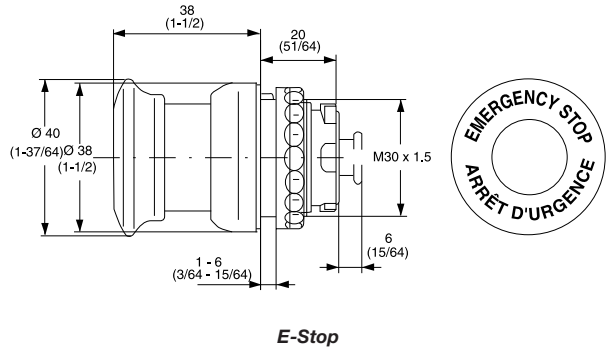
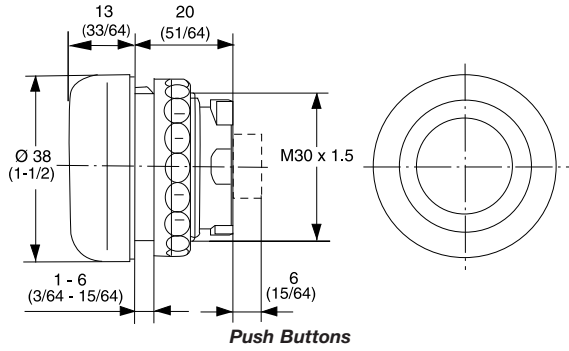
Marking	Suffix Number	Marking	Suffix Number
Automatico	T101	Disinserito	T163
Chiudere	T107	Disins-Ins	T165
Discesa	T110	Inserito	T166
Disturbo	T113	Salita	T182
Rapido	T114	Indietro	T188
Avanti	T120	Destra	T191
Avanti-Disins-Indietro	T122	Preparare	T198
Avanti-Indietro	T124	Lento	T201
Manuale	T126	Marcia	T208
Manuale-Auto	T127	Marcia-Arresto	T211
Manuale-Disins-Auto	T128	Arresto	T212
Alto	T129	Aprire	T223
Sinistra	T145	In Servizio	T243
Basso	T148	Rotazione CW	T246
Basso-Disins-Alto	T150	Rotazione CCW	T247
Abbassare	T152	Emergenza	T248

### Spanish

Marking	Suffix Number	Marking	Suffix Number
Cerrar	S107	Abrir	S170
Adelante	S120	Subida	S182
Adelante-Parada-Atrás	S123	Atrás	S188
Adelante-Atrás	S124	Derecha	S191
Manual	S126	Marcha	S208
Manual-Auto	S127	Marcha-Parada	S211
Izquierda	S145	Parada	S212
Bajada	S152	En Servicio	S243

**Approximate Dimensions**

Dimensions in millimeters (inches). Dimensions are not intended to be used for manufacturing purposes.

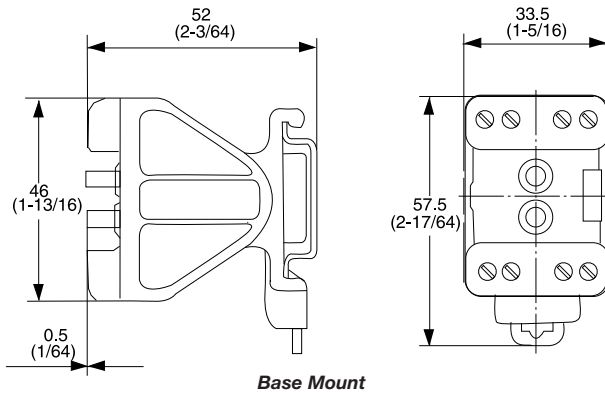
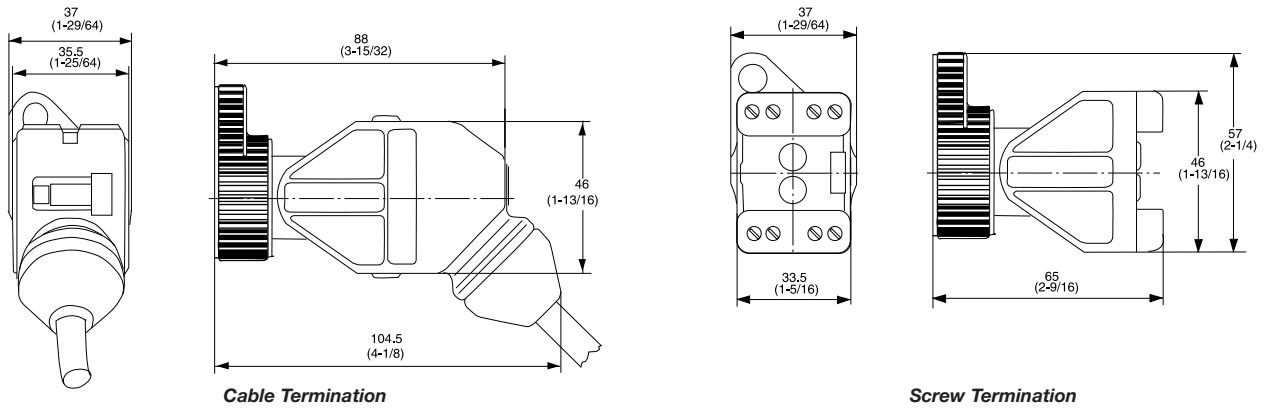


# Hazardous Location Push Buttons

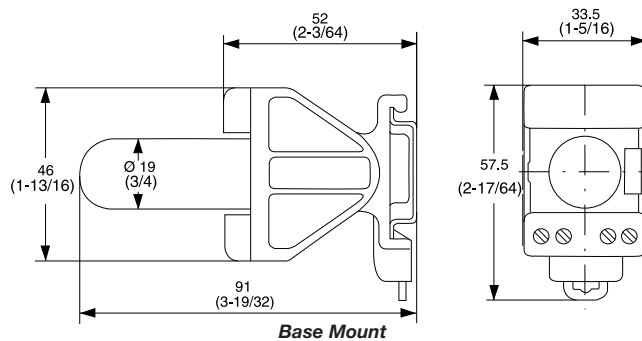
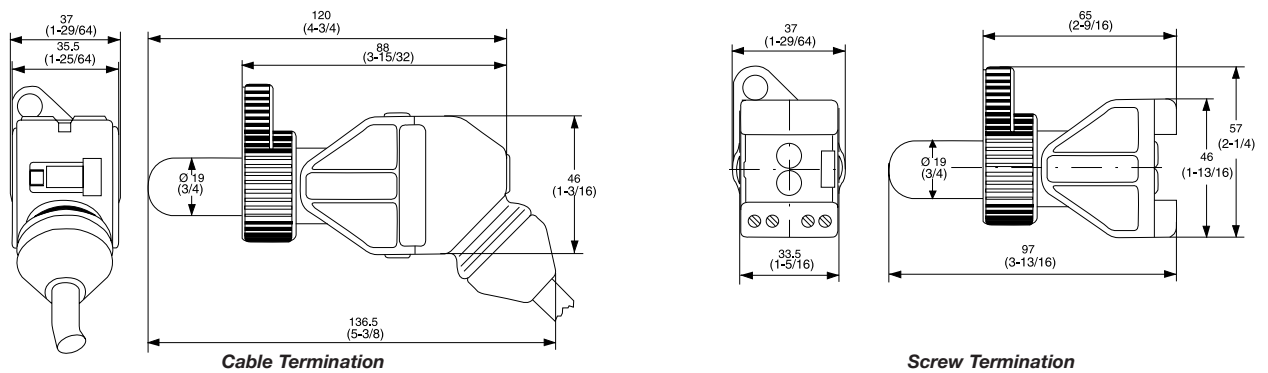
## Approximate Dimensions

Dimensions are in millimeters (inches). Dimensions are not intended to be used for manufacturing purposes.

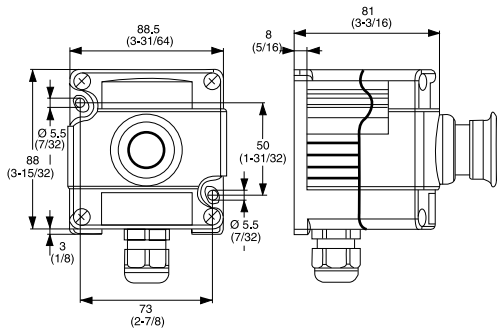
### Contact Block



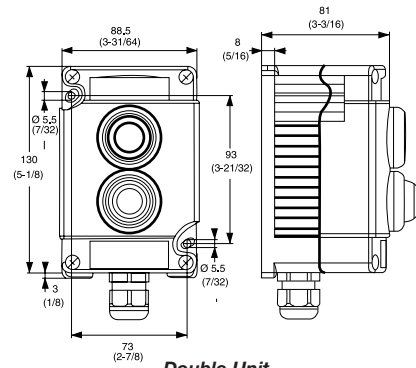
### Power Module



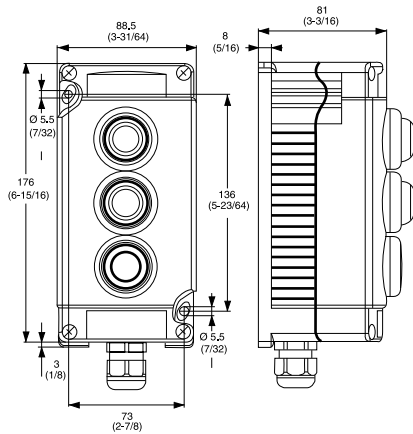
Dimensions are in millimeters (inches). Dimensions are not intended to be used for manufacturing purposes.



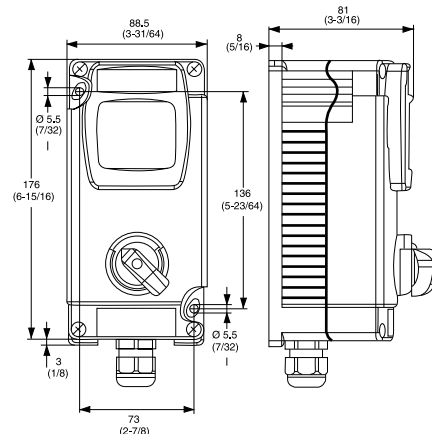
**Single Unit**



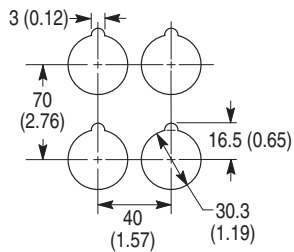
**Double Unit**



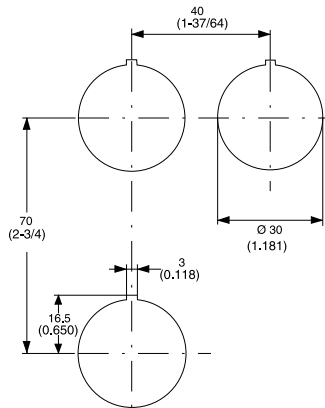
**Triple Unit**



**Measuring Instrument with Actuator**



**Vertical & Horizontal Spacing**



**Mounting Dimension**

# Palm-Operated Push Buttons

## Product Overview



### Bulletin 800P — Palm-Operated Push Buttons

The Bulletin 800P palm-operated push button is designed for applications requiring electromechanical operation for safety, resistance to RFI, and an ergonomically sensitive design to reduce risk factors associated with cumulative trauma disorders. Bulletin 800P units with articulated operation offer reduced operating force over standard drive units by permitting the button head to tilt for added comfort and mechanical advantage. Bulletin 800P operators are intended for applications requiring two-hand control wiring, per OSHA standards.

### Table of Contents

Product Selection..... 10-211  
 Accessories..... 10-212  
 Approximate Dimensions..... 10-213

### Specifications\*

Electrical Ratings		
Dielectric Strength	2200V for one minute	
Electrical Design Life Cycles	1 000 000 at maximum rated load 200 000 at maximum rated load (Logic Reed)	
Mechanical Ratings		
Vibration	10...2000 Hz 1.52 mm displacement (peak-to-peak) 10 G max.	
Shock	Mechanical shock at 1/2 cycle sine wave for 11 ms	
Contact Fragility	25 G 9 G 6 G	800T-XA1, -XA2, -XD1, -XD4, -XD2R, contact blocks 800T-XA, -XA4, -XD2, -XD3, -XAR, -XAV contact blocks 800T-XD1R No damage at 100 G all contact blocks
Degree of Protection	Type 1, 12, 4/13; watertight/oiltight 529 IP65	
Mechanical Design Life Cycles	Push Buttons	1 000 000 minimum
Contact Operation	Shallow Contact Block Logic Reed	Slow, double make and break Snap action
Typical Operating Forces	Articulated	800T-XD1 and 800T-XD4 contact blocks 3.7 lb maximum at center of button, 2.7 lb at perimeter
	Standard Drive	3.7 lb
Environmental		
Temperature Range	Operating Storage	+32...+131 °F (0...+55 °C) -40...+185 °F (-40...+85 °C)

**Note:** Operating temperatures at 0 °C (32 °F) are based on the absence of freezing moisture and liquids.

\* Performance Data — See page Important- 3.

### Standard Contact Ratings

(IEC 947-5-1) (NEMA ICS 2-125) Maximum continuous current  $I_{th}$  10 A. Bulletin 800P units have control circuit ratings with 800T-XA1, -XD1, -XD4, -XA2, -XA, -XA4, -XD2, and -XD3 contact blocks as follows:

Maximum Operational Volts $U_e$	Utilization Category		Rated Operational Currents		
	IEC	NEMA	Volts $U_e$	Make ↔	Break ↔
AC 600	AC-15	A600	120...600 72...120 24...72	7200VA 60 A 60 A	720VA 720VA 10 A
DC 600	DC-13	Q600	28...600 24...28	69VA 2.5 A	

(See page 10-213 for 800T-XAR, -XD1R, -XD2R data.)

### PenTUFF™ (Low Voltage) Contact Ratings

Minimum DC: 5V, 1 mA. Maximum thermal continuous current  $I_{th}$  2.5 A AC/1.0 A DC. Bulletin 800P units with Cat. No. 800T-XAV contacts have ratings as follows:

Maximum Operational Volts $U_e$	Utilization Category		Rated Operational Currents		
	IEC	NEMA	Volts $U_e$	Make ↔	Break ↔
AC 300	AC-15	C300	120...300 0...120	1800VA 15 A	180VA 1.5 A
DC 150	DC-13	R150	24...150 0...24	28VA 1.0 A	





Product Selection  
 Palm-Operated Push Buttons

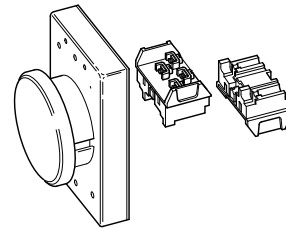


Palm-Operated Flush Mount Button  
 Cat. No. 800P-F2CA



Palm-Operated Surface Mount with Guard  
 Cat. No. 800P-S2CG1A

Operation Type	Contact Type	Guard Option	Flush Mounting	Surface Mounting
			Cat. No.	Cat. No.
Articulated	1 N.O. - 1 N.C.	None	<b>800P-F2CA</b>	<b>800P-S2C1A</b>
		Guard	<b>800P-F2CGA</b>	<b>800P-S2CG1A</b>
	2 N.O. - 2 N.C.	None	<b>800P-F2CB</b>	800P-S2C1B
		Guard	<b>800P-F2CGB</b>	<b>800P-S2CG1B</b>
Standard Drive	1 N.O. - 1 N.C.	None	<b>800P-F1CA</b>	<b>800P-S1C1A</b>
		Guard	<b>800P-F1CGA</b>	<b>800P-S1CG1A</b>
	2 N.O. - 2 N.C.	None	<b>800P-F1CB</b>	800P-S1C1B
		Guard	<b>800P-F1CGB</b>	<b>800P-S1CG1B</b>



800P – S 1 C G 1 A  
           a    b    c    d    e    f

**a**

Operator Type	
Code	Description
F	Flush mount
S	Surface mount

**c**

Button Color	
Code	Description
C	Chrome
R	Red (painted)
Y	Yellow (painted)

**e**

Enclosure Openings	
Code	Description
Blank	No base*
1	Single hub
2	Double hub

**b**

Button Operation	
Code	Description
1	Standard drive
2	Articulated

**d**

Guard Option	
Code	Description
Blank	No guard
G	Side guard — yellow
H	Die cast — grey

**f**






Contact Black	
Standard	
Code	Description
A	1 N.O. - 1 N.C.
B	2 N.O. - 2 N.C.
PenTUFF (Low Voltage)	
Code	Description
AV	1 N.O. - 1 N.C.
BV	2 N.O. - 2 N.C.

\* Only used for flush mounted operators.

# Palm-Operated Push Buttons

## Accessories

### Accessories

	Description	Button Color	Cat. No.	Cat. No.
			Standard	Anti-Slip
 <p><i>Standard Button Cover</i> Cat. No. <b>800P-NCB</b></p> <p><i>Anti-Slip Button Cover</i> Cat. No. <b>800P-NCG1</b></p>	<p><b>Button Covers</b> Button covers are used to reduce possible slipping due to fluids on the operator.</p>	Red	<b>800P-NCR</b>	800P-NCR1
		Black	<b>800P-NCB</b>	800P-NCB1
		Green	<b>800P-NCG</b>	800P-NCG1
		Yellow	800P-NCY	800P-NCY1
 <p><i>Side Guard</i> Cat. No. <b>800P-NBG1</b></p> <p><i>Die Cast Guard</i> Cat. No. <b>800P-NBG</b></p>	<p><b>Guards</b> These guards prevent accidental activation of the button and protect it from damage. <b>Note:</b> Guards are required in most two hand safety applications (See OSHA and ANSI standards).</p>	Style	Color	Cat. No.
		Side	Yellow	<b>800P-NBG1</b>
		Die Cast	Grey	<b>800P-NBG</b>
		Die Cast	Yellow	<b>800P-NBGY</b>
 <p><i>Single Hub Base</i> Cat. No. <b>800P-B1</b></p> <p><i>Double Hub Base</i> Cat. No. <b>800P-B2</b></p>	<p><b>Bases</b> The conduit hub(s) on these replacement mounting bases come with a 3/4 in. opening.</p>	Style	Cat. No.	
		Single Hub	<b>800P-B1</b>	
 <p><i>Standard Adapter</i> Cat. No. <b>800P-N150</b></p> <p><i>FS Adaptor</i> Cat. No. <b>800P-N4</b></p>	<p><b>Adaptors</b> These adaptor flanges are used between the operator and the mounting base, when using a non-Allen-Bradley base.</p>	Enclosure	Cat. No.	
		Standard*	<b>800P-N150</b>	
 <p><b>Legend Plates</b></p>	<p><b>Legend Plates</b> These legend plates can be mounted on the cover.</p>	FS	800P-N4	
		Marking	Cat. No.	
		Blank (Grey)	800P-X107*	
		Blank (Red)	800P-X129*	
		START	<b>800P-X130</b>	
		STOP	<b>800P-X131</b>	
		INCH	800P-X132	
		RUN	<b>800P-X133</b>	
RUN INCH	<b>800P-X134</b>			
TOP STOP	800P-X135			

\* Horizontal mounting holes are 2-3/8 in. (60.3 mm) center-to-center. Vertical mounting holes are 4-1/2 in. (114.3 mm) center-to-center.

\* To order with custom engraved text, add suffix **E** and supply text. One or two lines of text with maximum of 5 characters per line.

# Palm-Operated Push Buttons

## Modifications and Accessories/Approximate Dimensions

### Modifications and Accessories

#### Contact Blocks

Packaged in a kit form for field installation. All necessary mounting hardware is provided with each contact block kit. Contact ratings are listed on page 10-210.

**Note:** It is recommended to mount no more than four contact blocks on any one unit (maximum two blocks deep).



Shallow Block



PentUFF (Low Voltage)  
Contact Block



Logic Reed Block

Contact Type	Shallow Block*	PentUFF Block*	Logic Reed Block‡
	Cat. No.	Cat. No.	Cat. No.
1 N.O.	<b>800T-XD1</b>	<b>800T-XD1V</b>	<b>800T-XD1R</b>
1 N.C.	<b>800T-XD2</b>	<b>800T-XD2V</b>	<b>800T-XD2R</b>
1 N.O. - N.C.	<b>800T-XA</b>	<b>800T-XAV</b>	<b>800T-XAR</b>

**Note:** Contact blocks with normally closed contacts meet direct drive positive opening standard requirements.

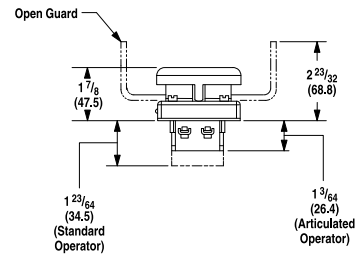
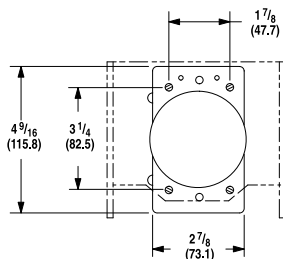
‡ Logic Reed blocks can be physically mounted on a Bul. 800P operator, but this combination is not UL Listed for Class 1 Div 2 hazardous applications.

\* For contact ratings, see page 10-4.

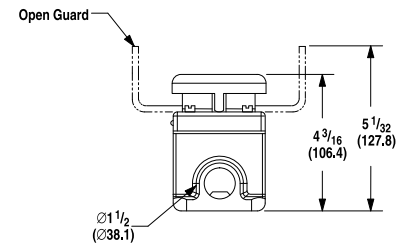
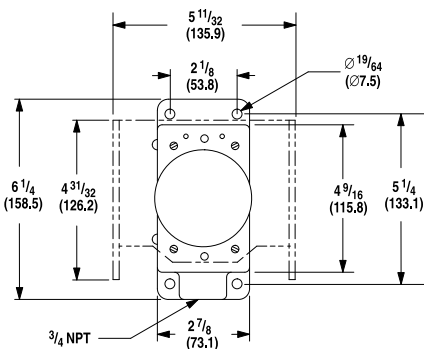
### Approximate Dimensions

Dimensions in inches (millimeters). Dimensions are not intended to be used for manufacturing purposes.

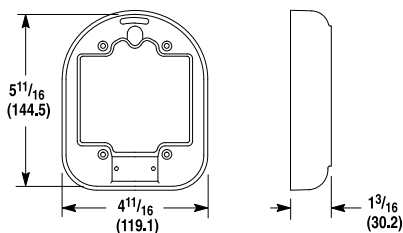
#### Flush Mounting



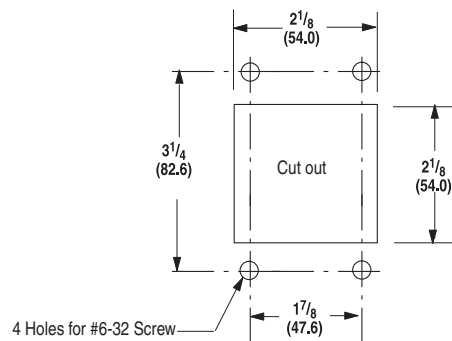
#### Surface Mounting



#### Die Cast Guard (800P-NBG or 800P-NBGY)



#### Cutout and mounting screw locations for a flush mounted cover





**Bulletin 800Z — Zero-Force Touch Buttons™**

Bulletin 800Z Zero-Force Touch Buttons are ideally suited for use in two-hand machine control systems and highly repetitive applications.

**Ergonomic Design** — The contour shape fits the palm of the hand for ease of operation and helps deter attempts to defeat two-hand control.

**Zero Force to Operate** — The electronic design with two interlinked capacitive sensors in offset planes provides increased sensitivity and good ability for distinguishing between a person's hand, even through most industrial gloves, versus most foreign objects.



**ATTENTION:** Not recommended for use in applications where there is high probability for exposure to liquid (e.g., cutting fluid) on the sensing surface area.

**Table of Contents**

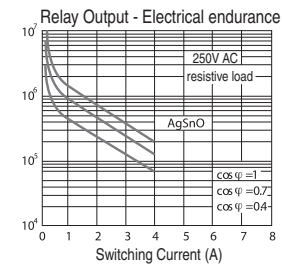
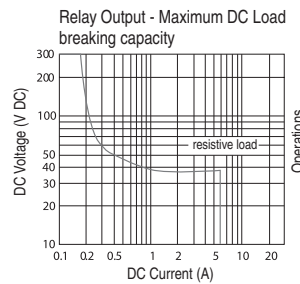
Specifications..... this page  
 General Purpose Line ..... 10-215  
 Heavy Industrial Line 10-216  
 Quick Disconnect  
 Cables ..... 10-216  
 Accessories..... 10-217  
 Wiring Diagram ..... 10-219  
 Approximate Dimensions..... 10-220

**Specifications**

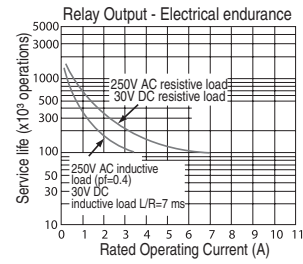
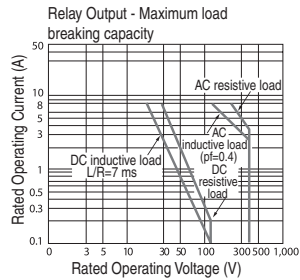
**Mechanical Ratings**

Description	General Purpose Line (800Z-G)	Heavy Industrial Line (800Z-H)
<b>Mechanical Ratings</b>		
Vibration Endurance	Tested @ 10 G, 1.52 mm displacement	
Mechanical Shock	Tested @ 100 G (mechanical durability)	
Degree of Protection	Type 4/4X/13 IP66 1200 psi Washdown	Type 4/13 IP66
Operating Force	Zero	
<b>Electrical Ratings</b>		
Input Voltage (Relay type)	Low Voltage: 10...40V DC, 20...30V AC Full Voltage (800Z-GF): 100...240V AC (+10%, -15%)	
Input Voltage (Solid-State type)	Low Voltage (800Z-GN/GP): 10...30V DC	
Electrical Design Life (Relay type)	Relay output 200 000 Operations @ 2 A inductive 4 A resistive	Relay output 150 000 Operations @ 5 A inductive 2.5 A resistive
Degree of Protection	IP2X	
Wire Range	#22...12 AWG (0.5...4 mm <sup>2</sup> )	
Tightening Torque	9 lb•in (1 N•m)	
On-delay/Off-delay	Off 60 ms max. On 76 ms max.	
Current Draw (Solid-State type)	100 mA at 24V DC = 2.23 W (no external load)	
<b>Environmental</b>		
Temperature Range (Operating)	-25...+55 °C (-13...+131 °F)	
Temperature Range (Storage)	-40...+85 °C (-40...+185 °F)	
Humidity	95% RH from 25...50 °C (77...122 °F) (full operation)	
<b>Materials</b>		
Housing/Guard	Valox 357	
Gasket	BUNA-N	1/16 in. Cork-BUNA-N
Connector	Insulator material (micro connector) = nylon Insulator material (mini connector) = PVC	
<b>Standards and Certifications</b>		
Certifications	cULus, CE, C-TICK, CSA	
Standards Conformity	UL 508, CSA 22.2 No. 14, EN/IEC 60947-5-1, EN50081-2, EN61000-6-2, EN60954-1, EN60204-1	

**Load Life Curves for General Purpose Product Line**



**Load Life Curves for Heavy Industrial Line**



**Applications Detail**






LED Blink Rate	Diagnostic	Description
** ** *	Power Up	Device touched during power up. Device will resume 10 seconds after removal of hand.
*** ** *	Noise Detection	Device detected an unacceptable level of noise (>20 V/m). Device will resume once noise subsides.
**** ** *	Margin Detection	A conductive film is building up on the sensing surface. Device will resume once cleared.








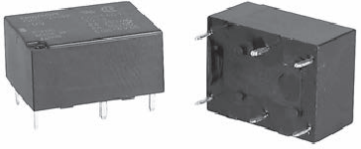



Accessories — General Purpose

	Description		Cat. No.
 <p><b>Cat. No. 800Z-G3AG1</b>      <b>Cat. No. 800Z-G3AG2</b></p>	<p><b>Guards</b>            These guards help protect against accidental activation of the touch button surface and protect it from damage. Can be used for both the 22.5 mm and 30.5 mm mounted products.</p>	Yellow Plastic	<b>800Z-G3AG1</b>
		Black Plastic	<b>800Z-G3AG2</b>
 <p><i>Plastic Mounting Kit</i>  <b>Cat. No. 800Z-G2AH1</b></p>	<p><b>Mounting Ring Nut for 22.5 mm Holes</b>            Used on 22.5 mm devices.</p>	<b>800Z-G2AH1</b>	
 <p><i>Plastic Mounting Kit</i>  <b>Cat. No. 800Z-G3AH1</b></p>	<p><b>Mounting Ring Nut for 30.5 mm Hole</b>            Used on 30.5 mm devices.</p>	<b>800Z-G3AH1</b>	
 <p><i>Swivel Assembly</i>  <b>Cat. No. 60-2439</b></p>	<p><b>30.5 mm Swivel/Tilt Mounting Assembly</b>            This bracket allows you to orient the touch button in any position. It can be mounted on any vertical or horizontal surface. Compatible with 30.5 mm mounting only.</p>	2.25 in. (57 mm)	<b>60-2681</b>
		1.15 in. (29 mm)	<b>60-2439</b>
 <p><b>Cat. No. 800E-AHA1</b></p>	<p><b>30.5 mm to 22.5 mm Hole Size Adapter</b>            This adapter allows a 22.5 mm push button operator to be installed in a panel with existing 30.5 mm mounting holes.</p>	Metal	<b>800F-AHA1</b>
		Black Metal	<b>800E-AHA2</b>



Accessories — Heavy Industrial

	Description		Cat. No.
 <p><b>Cat. No. 800Z-HAG1</b></p>	<p><b>Guard</b> This guard helps protect against accidental activation of the touch surface and protects it from damage. Mounting screws are included.</p>	<p>Yellow Plastic</p>	<p><b>800Z-HAG1</b></p>
 <p><i>Single Hub Base</i> <b>Cat. No. 800P-B1</b></p> <p><i>Double Hub Base</i> <b>Cat. No. 800P-B2</b></p>	<p><b>Mounting Bases</b> The heavy industrial line products mount directly on these bases. The conduit hub(s) come with a 3/4 inch opening.</p>	<p>1</p>	<p><b>800P-B1</b></p>
		<p>2</p>	<p><b>800P-B2</b></p>
 <p><b>Cat. No. 800P-N150</b></p>	<p><b>Adapter</b> This adapter is used if mounting touch button onto a 4-1/2 in. x 2-3/8 in. (114.3 x 60.3 mm) enclosure pattern.</p>		<p><b>800P-N150</b></p>
 <p><b>Cat. No. 800Z-N12</b></p>	<p><b>Replacement Relay</b> <b>Note:</b> Package quantity of 2.</p>	<p>10...264V</p>	<p><b>800Z-N12</b></p>
 <p><b>Cat. No. 800Z-HAH1</b></p>	<p><b>Replacement Screws</b></p>	<p>Guard-to-Base Mounting <b>Note:</b> package quantity of 4</p>	<p><b>800Z-HAH1</b></p>
		<p>Base Mounting <b>Note:</b> package quantity of 4</p>	<p><b>800Z-HAH2</b></p>

**Wiring Diagrams — Touch Button Terminations**

**General Purpose Line**

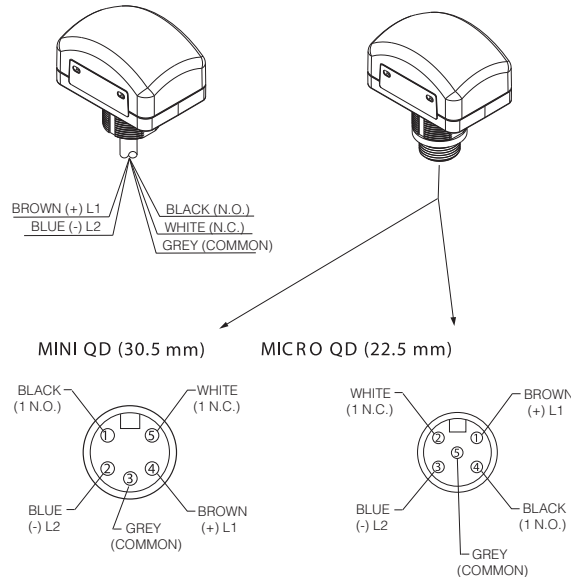
Electrical Connections: 10...40V DC and 20...30V AC Input Voltage (Relay Output); 100...240V AC Input Voltage (Relay Output)

Note: Separate N.O. and N.C. output relays with shared common.

**5-Conductor Cabled (Relay Output)**

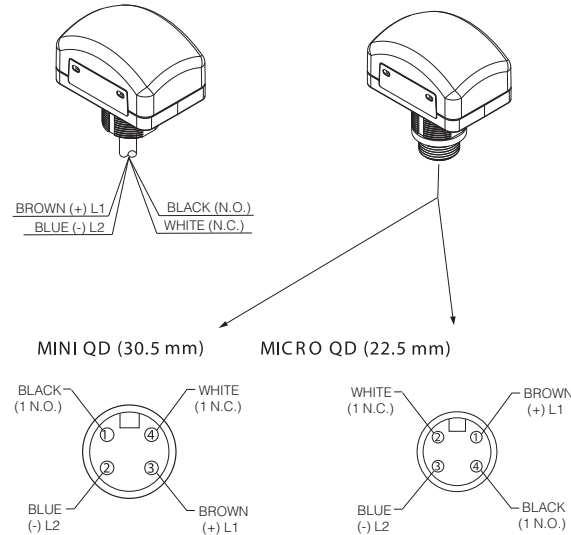
For 800Z-GL \_ \_ \_

For 800Z-GF \_ \_ \_

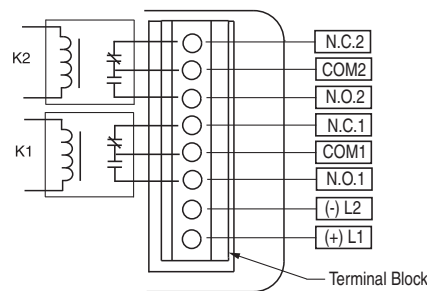


Electrical Connections: 10...30V DC Input Voltage (Transistor Output); 150 mA Max. per Circuit Output

**4-Conductor Cabled**



**Heavy Industrial Line**



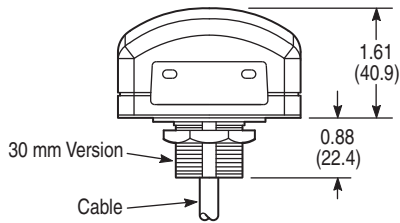
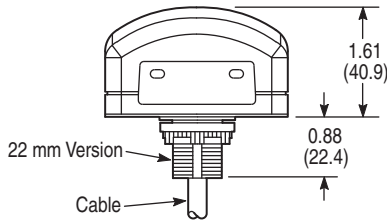
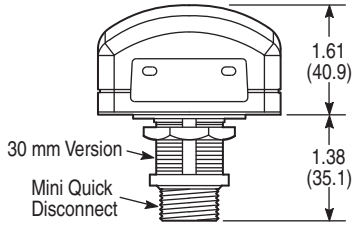
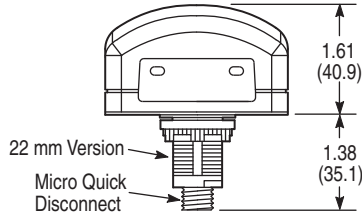
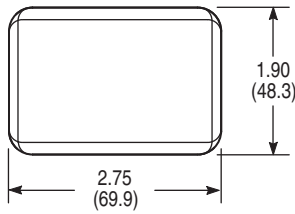
# Zero-Force Touch Buttons™

## Approximate Dimensions

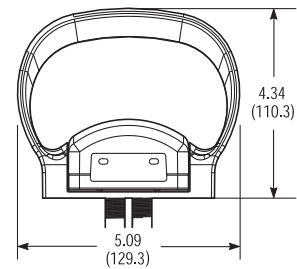
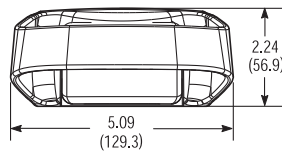
### Approximate Dimensions

Dimensions in inches (millimeters). Dimensions are not intended to be used for manufacturing purposes.

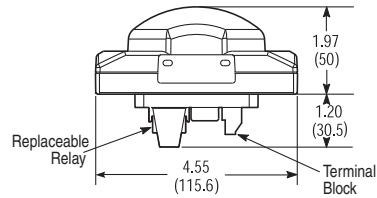
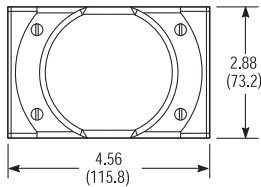
### General Purpose



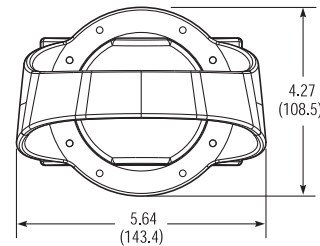
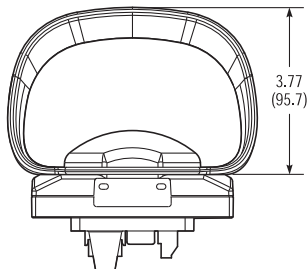
### General Purpose With Guard



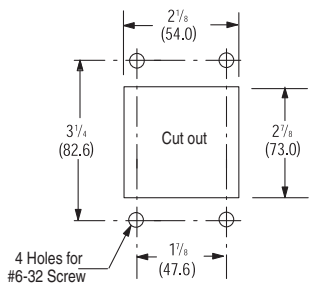
### Heavy Industrial



### Heavy Industrial With Guard




### Cutout and Mounting Screw Locations for a Flush Mounted Cover



# 12 mm, 18 mm, 22 mm, and 30 mm Indicators

## Product Overview/Selection

	<b>Bulletin 800L — 12, 18, 22, and 30 mm Indicators</b> <ul style="list-style-type: none"> <li>• Economical, commercial-grade indicators</li> <li>• LED/strobe/incandescent</li> <li>• Shallow back-of-panel depth</li> <li>• Type 4/4X/13, watertight/oiltight (12 mm is Type 1)</li> <li>• 18, 22, and 30 mm devices are rated for use in Class 1 Div. 2 Groups A, B, C, D and Class 2 Div. 2 Groups F, G.</li> </ul>	<b>Table of Contents</b> Product Selection ..... this page Approximate Dimensions..... 10-222  <b>Standards Compliance</b> UL 508 <b>Certifications</b> cULus Listed (File No. E14840, Guide No. NKCR, NKCR7) EN60947-5-1 CSA C22.2, No. 14 CE Marked
---	---	---

### Specifications\*

Mechanical Ratings		
Vibration	10...2000 Hz 1.52 mm displacement (peak-to-peak) max./10 G max	
Shock	1/2 cycle sine wave for 11 ms ≥ 25 G	
Degree of protection	12 mm: Type 1 18, 22, and 30 mm: Type 1/4/4X/12/13; watertight/oiltight IEC 529 IP66	
Environment		
Temperature range	Operating	-40...+131 °F (-40...+55 °C)
	Storage	-40...+185 °F (-40...+85 °C)
Humidity	50% at 104 °F (40 °C)	
Lamp Ratings		
Lamp life	Incandescent	5 000 Hrs.
	LED	100 000 Hrs.
	Strobe	1 000 000 Flashes
Flash frequency	Strobe	1...2 Hz

\* Performance Data — See Important- 3.

### Product Selection

#### 12 mm Indicators

Color	6 in. Pigtail Leads		Terminals	
	24V DC	120V AC	24V DC	120V AC
	Cat. No.	Cat. No.	Cat. No.	Cat. No.
Amber	800L-12L24A	800L-12L10A	800L-12L24AS	800L-12L10AS
Blue	800L-12L24B	800L-12L10B	800L-12L24BS	800L-12L10BS
Clear	800L-12L24C	800L-12L10C	800L-12L24CS	800L-12L10CS
Green	800L-12L24G	800L-12L10G	800L-12L24GS	800L-12L10GS
Red	800L-12L24R	800L-12L10R	800L-12L24RS	800L-12L10RS

#### 18 mm Indicators

Color	LED*			Incandescent	
	24V AC/DC	120V AC	240V AC	24V AC/DC	120V AC/DC
	Cat. No.	Cat. No.	Cat. No.	Cat. No.	Cat. No.
Amber	800L-18L24A	800L-18L10A	800L-18L20A	800L-18C24A	800L-18C10A
Blue	800L-18L24B	800L-18L10B	800L-18L20B	800L-18C24B	800L-18C10B
Clear	800L-18L24C	800L-18L10C	800L-18L20C	800L-18C24C	800L-18C10C
Green	800L-18L24G	800L-18L10G	800L-18L20G	800L-18C24G	800L-18C10G
Red	800L-18L24R	800L-18L10R	800L-18L20R	800L-18C24R	800L-18C10R

#### 22 mm Indicators

Color	LED*			Incandescent		Strobe	
	24V AC/DC	120V AC	240V AC	24V AC/DC	120V AC/DC	24V AC/DC	120/240V AC
	Cat. No.	Cat. No.	Cat. No.	Cat. No.	Cat. No.	Cat. No.	Cat. No.
Amber	800L-22L24A	800L-22L10A	800L-22L20A	800L-22C24A	800L-22C10A	800L-22S24A	800L-22S10A
Blue	800L-22L24B	800L-22L10B	800L-22L20B	800L-22C24B	800L-22C10B	800L-22S24B	800L-22S10B
Clear	800L-22L24C	800L-22L10C	800L-22L20C	800L-22C24C	800L-22C10C	800L-22S24C	800L-22S10C
Green	800L-22L24G	800L-22L10G	800L-22L20G	800L-22C24G	800L-22C10G	800L-22S24G	800L-22S10G
Red	800L-22L24R	800L-22L10R	800L-22L20R	800L-22C24R	800L-22C10R	800L-22S24R	800L-22S10R

\* LED color matches lens color specified. White LED supplied for clear selection.



www.ab.com/catalogs Preferred availability cat. nos. are **bold**.

Publication A117-CA001A-EN-P



# 12 mm, 18 mm, 22 mm, and 30 mm Indicators

## Product Selection

### Product Selection, Continued

#### 30 mm Indicators

Color	LED*			Incandescent		Strobe	
	24V AC/DC Cat. No.	120V AC Cat. No.	240V AC Cat. No.	24V AC/DC Cat. No.	120V AC/DC Cat. No.	24V AC/DC Cat. No.	120/240V AC Cat. No.
Amber	800L-30L24A	800L-30L10A	800L-30L20A	800L-30C24A	800L-30C10A	800L-30S24A	800L-30S10A
Blue	800L-30L24B	800L-30L10B	800L-30L20B	800L-30C24B	800L-30C10B	800L-30S24B	800L-30S10B
Clear	800L-30L24C	800L-30L10C	800L-30L20C	800L-30C24C	800L-30C10C	800L-30S24C	800L-30S10C
Green	800L-30L24G	800L-30L10G	800L-30L20G	800L-30C24G	800L-30C10G	800L-30S24G	800L-30S10G
Red	800L-30L24R	800L-30L10R	800L-30L20R	800L-30C24R	800L-30C10R	800L-30S24R	800L-30S10R

\* LED color matches lens color specified. White LED supplied for clear selection.

**800L - 30 L 24 R**  
a    b    c    d

Indicator Size		Illumination Type		Voltage		Lens Color	
Code	Description	Code	Description	Code	Description	Code	Description
12	12 mm	C	Incandescent	24	24V AC/DC*	R	Red
18	18 mm*	L	LED*§	10	120V AC	G	Green
22	22.5 mm	S	Xenon strobe*	20	240V AC‡	A	Amber
30	30.5 mm					B	Blue
						C	Clear

\* 18 mm indicators are only available with LED or incandescent illumination. For 18 mm devices with 120V incandescent lamps, it is recommended that the lens is changed with lamp replacement.

§ LED and Xenon strobe lamps are integral to indicators and are not field replaceable. Entire indicator must be replaced upon lamp failure.

‡ Incandescent illumination not available in 240V option. For 240V strobe, order voltage code **10** (Table c) as strobe is rated for both 120V/240V AC.

§ LED color will match lens color specified. White LED supplied for clear lens.

\* 12 mm devices are only available with LED illumination (24V DC or 120V AC).

### Replacement Parts

#### Replacement Lens Caps

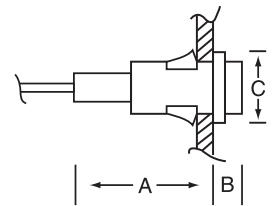
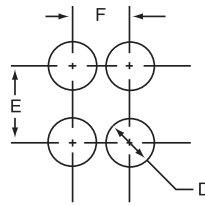
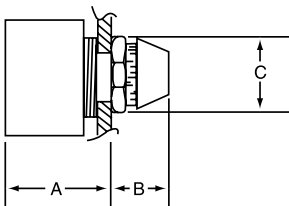
Color	18 mm	22 mm	30 mm
Red	800L-N18R	800L-N22R	800T-N26R
Green	800L-N18G	800L-N22G	800T-N26G
Amber	800L-N18A	800L-N22A	800T-N26A
Blue	800L-N18B	800L-N22B	800T-N26B
Clear	800L-N18C	800L-N22C	800T-N26C

#### Replacement Lamps

Lamp Type	Voltage	ANSI No.	Cat. No.
Incandescent	24V AC/DC	757	800T-N157
	120V AC/DC	949	800T-N169

➤ LED and Xenon strobe lamps are integral to indicators and are not field replaceable. Entire indicator must be replaced upon lamp failure.

### Approximate Dimensions



Indicator	A	B	C	D	E	F
	Inches (mm)					
12 mm	1-3/32 (27.8)	5/16 (7.9)	5/8 (15.8)	1/2 (12.7)	3/4 (19.0)	11/16 (17.5)
18 mm	1-21/64 (33.7)	57/64 (22.6)	1-1/32 (26.2)	3/4 (18.6)	2-9/32 (58.0)	1-1/8 (28.6)
22 mm	1-21/64 (33.7)§	57/64 (22.6)	1-7/32 (31.0)	15/16 (22.6)	2-9/32 (58.0)	1-8/32 (32.5)
30 mm	1-9/16 (39.7)§	1-9/64 (29.0)	1-19/32 (40.5)	1-13/64 (30.6)	2-9/32 (58.0)	1-29/32 (48.5)

§ For devices with strobe illumination, Dimension A for 22 mm is 2-7/8 in. (73 mm) and for 30 mm devices it is 3-1/8 in. (79 mm).



**Bulletin 800S — Standard Duty Stations**

Bulletin 800S standard duty push button stations are used in control circuits. They offer compact size and dependable performance.

NEMA Type 1 general purpose stations have been designed for greater operating flexibility and ease of wiring. The cover of the station contains the entire contact mechanism. Wiring terminals are located in the base. Spring type, silver plated contacts connect the two assemblies. This unique construction will speed up installation and maintenance. Operating buttons can be rotated 90° to make them suitable for horizontal mounting. This change can be made in the field.

NEMA Type 4 enclosures are die cast aluminum. Standard stations are supplied with a 3/4 in. pipe tap at the bottom.

**Table of Contents**

Contact Ratings ..... 10-225  
 Accessories..... 10-225  
 Approximate  
 Dimensions..... 10-226

**Pilot Lights**

- Push button stations with pilot lights can operate on either 120V or 240V by changing connections. A red pilot lens is supplied.

**Selector Switches**

- All two-position Bulletin 800S standard duty selector switch stations can be changed to three-position in the field, and the three-position selector switches can be changed to two-position. Instructions for changing are included with each station.
- In addition to the standard marking, all selector switches are supplied with adhesive backed metal legend plates, marked as follows: OFF-ON, FOR-REV, HAND-AUTO, OPEN-CLOSE, HIGH-LOW, SUMMER-WINTER, SUMMER-OFF-WINTER, HIGH-OFF-LOW, OPEN-OFF-CLOSE, FOR-OFF-REV, HAND-OFF-AUTO.

**Product Selection**  
**Complete Assembled Stations**



*Flush Mount Units fit a standard GEM or Handy Type Wall Box. Contact Symbol 3  
 Cat. No. 800S-2AS*

Type 1 Flush Mount Unit* — Wall Box not included			
Legend Marking	Contact Symbol▶	Grey Painted Flush Plate	Stainless Steel Flush Plate
		Cat. No.	Cat. No.
START STOP	<b>3</b>	<b>800S-2AS</b>	800S-2ASQ

\* Not rated for DC operation.



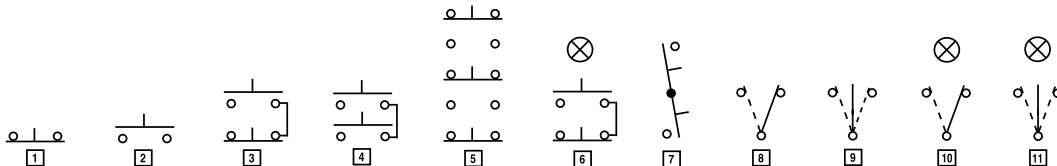
**Cat. No. 800S-2SAP**



**Cat. No. 800S-2SCM**

Momentary Contact Buttons and Pilot Light — 120V or 240V, Type 1.			Maintained Contact Buttons — Type 1		
Legend Marking	Contact Symbol▶	Cat. No.	Legend Marking	Contact Symbol▶	Cat. No.
No Legend START STOP	<b>6</b>	<b>800S-2SAP</b>	No Legend ON OFF	<b>7</b>	800S-2SCM
			No Legend START STOP	<b>7</b>	<b>800S-2SBM</b>

**▶Contact Symbols**



Bulletin 800S  
**Standard Duty Stations**  
 Product Selection

Complete Assembled  
 Stations, Continued



Cat. No. 800S-R3SX



Cat. No. 800S-R2SXP

Selector Switches — Type 1				Selector Switch and Pilot Light — 120V or 240V, Type 1			
Legend Marking	Operator Type	Contact Symbol➤	Cat. No.	Legend Marking	Operator Type	Contact Symbol➤	Cat. No.
OFF-ON	2-Position Selector Switch		800S-R2SX	No Legend OFF-ON	Pilot Light, 2- Position Selector Switch		800S-R2SXP
HAND-OFF-AUTO	3-Position Selector Switch		<b>800S-R3SX</b>	No Legend HAND OFF AUTO	Pilot Light, 3- Position Selector Switch		800S-R3SXP



Cat. No. 800S-2SA



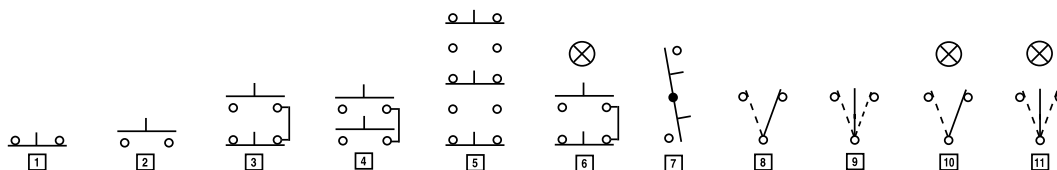
Cat. No. 800S-2SA4

Momentary Contact Buttons		Contact Symbol➤	Type 1	Type 4 Die Cast Aluminum Enclosure **
Legend Marking	Contact Type		Cat. No.	Cat. No.
STOP	1 N.C.		<b>800S-1SA</b>	800S-1SA4
	1 N.O.		800S-1SAK	800S-1SAK4
START	—		800S-1SB	800S-1SB4
START STOP	1 N.O. - 1 N.C.		<b>800S-2SA</b>	<b>800S-2SA4</b>
	1 N.O. - 1 N.O.		800S-2SAK	800S-2SAK4
FOR REV	—		<b>800S-2SB</b>	800S-2SB4
OPEN CLOSE	—		800S-2SF	800S-2SF4
ON OFF	1 N.O. - 1 N.C.		800S-2SE	800S-2SE4
	1 N.O. - 1 N.O.		800S-2SEK	800S-2SEK4
RAISE LOWER	—		<b>800S-2SD</b>	800S-2SD4
UP DOWN	—		<b>800S-2SC</b>	<b>800S-2SC4</b>
FAST SLOW STOP	—		800S-3SF	—
FOR REV STOP	—		<b>800S-3SA</b>	—
OPEN CLOSE STOP	—		<b>800S-3SD</b>	—
RAISE LOWER STOP	—		800S-3SB	—
UP DOWN STOP	—		<b>800S-3SC</b>	—

\* Not rated for DC operation.

\*\* Flip levers permit attachment of lock without additional accessory.

➤ Contact Symbols



www.ab.com/catalogs Preferred availability cat. nos. are bold.



**Contact Ratings**




(IEC 337-1) (NEMA ICS 2-125) Maximum Continuous Current  $I_{th}$  5 A. Bulletin 800S push button stations have control circuit ratings as follows:

Maximum Operational Voltage $U_e$	Utilization Category		Rated Operational Current		
	IEC	NEMA	Volts $U_e U_e$	Make	Break
				▶ ◀	◀ ▶
AC 600	AC-11	B600	480...600	3600VA	360VA
			240...480	3600VA	360VA
			120...240	30 A	3.0 A
DC 600	DC-11	P600	28...600	138VA	
			24...28‡	5.0 A	

‡ For applications below 24V and 24 mA, Bulletin 800T units with Logic Reed, sealed switch, or stackable sealed switch contact blocks are recommended.

**Accessories**

**Complete Assembled Stations**

	Description	Cat. No.
 <i>Cat. No. 800S-N90R</i>	<b>Pilot Light Lens</b> Red lens replacement cap.	800S-N90R
 <i>Cat. No. 800S-N60</i>	<b>Lamp</b> 120V lamp	800S-N60
 <i>Cat. No. 800S-N1</i>	<b>Locking Attachments</b> This device is used with extended push buttons or 2-position selector switches.	800S-N1
	This device is used with 3-position selector switches, to lock in the right or left position.	800S-N4

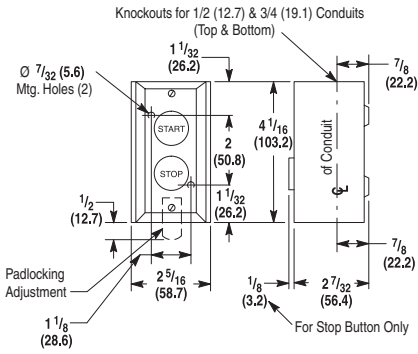
# Standard Duty Stations

## Approximate Dimensions

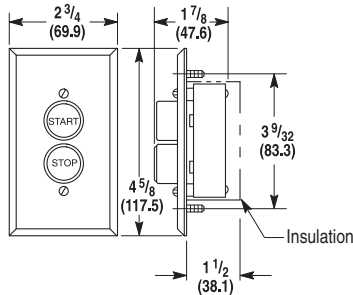
### Approximate Dimensions and Shipping Weights

Dimensions in inches (millimeters). Dimensions are not intended to be used for manufacturing purposes.

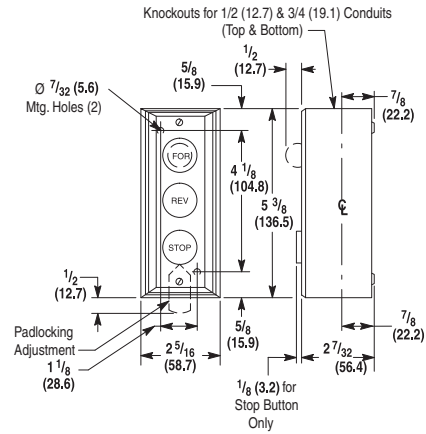
#### Type 1 — General Purpose Enclosures



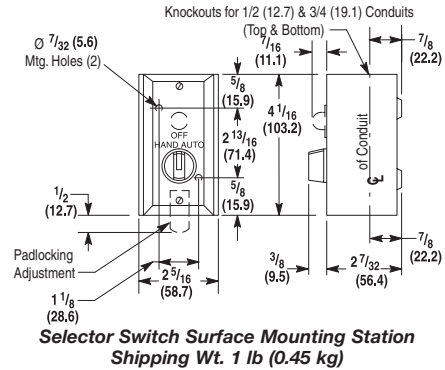
**One- and Two-Unit  
Surface Mounting Stations**  
Shipping Wt. 1 lb (0.45 kg)



**Three-Unit Surface Mounting Station**  
Shipping Wt. 1 lbs (0.45 kg)

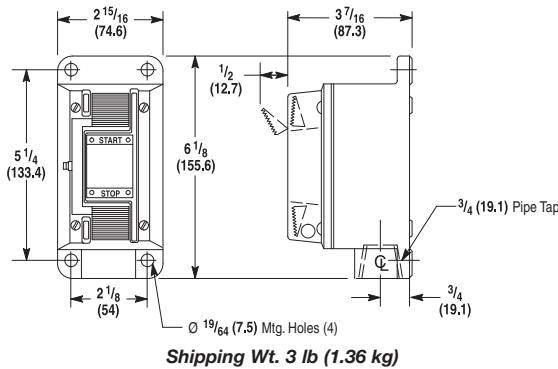


**Two-Unit Flush Mounting Station**  
Shipping Wt. 2 lbs (0.91 kg)



**Selector Switch Surface Mounting Station**  
Shipping Wt. 1 lb (0.45 kg)

#### Type 4 — Watertight Enclosure



**Shipping Wt. 3 lb (1.36 kg)**